

TURCK

Your Global Automation Partner

TBEN-L...-8IOL

IO-Link Master Module

Instructions for Use

Table of Contents

1	About these instructions	6
1.1	Target groups	6
1.2	Explanation of symbols	6
1.3	Additional documents	6
1.4	Feedback about these instructions	6
2	Notes on the product	7
2.1	Product identification	7
2.2	Scope of delivery	7
2.3	Turck service	7
3	For your safety	8
3.1	Intended use	8
3.2	Foreseeable Misuse	8
3.3	General safety instructions	8
3.4	Notes on Ex protection	8
3.5	Requirements for Ex approval	9
4	Product description	10
4.1	Device overview	11
4.1.1	Block diagram	12
4.1.2	Operating elements	12
4.1.3	Indication elements	12
4.2	Properties and features	13
4.3	Operating principle	13
4.4	Functions and operating modes	14
4.4.1	Multiprotocol technology	14
4.4.2	IO-Link channels	15
4.4.3	Universal digital channels – functions	16
4.4.4	Passive safety	16
4.4.5	Backplane Ethernet Extension Protocol (BEEP)	16
4.4.6	Turck Field Logic Controller function (FLC ARGEE)	17
4.5	Possible Ethernet network structures	17
4.5.1	Ethernet daisy chain - max. number of connected modules	19
5	Installing	20
5.1	Installing a device in zone 2 and zone 22	20
5.2	Mounting onto a mounting plate	21
5.3	Outdoor device installation	21
5.4	Grounding the device	22
5.4.1	Equivalent wiring diagram and shielding concept	22
5.4.2	Shielding of the fieldbus and I/O level	23
5.4.3	Disconnecting the direct grounding of the fieldbus level: removing the grounding clip	24
5.4.4	Grounding the fieldbus level directly: inserting the grounding clip	24
5.4.5	Grounding the device – mounting on a mounting plate	24
6	Connecting	25
6.1	Connecting a device in zone 2 and zone 22	25
6.2	Connecting the device to Ethernet	26
6.2.1	Applications with QuickConnect (QC) and Fast Start Up (FSU)	26

6.3	Connecting the power supply	27
6.3.1	Supply concept	28
6.4	Connecting IO-Link devices and digital sensors	29
7	Commissioning	31
7.1	Adjusting network settings and operation mode	31
7.1.1	Adjusting network settings and operation mode via rotary coding switches	31
7.1.2	Adjusting network settings via TAS (Turck Automation Suite)	34
7.1.3	Adjusting network settings via the web server	36
7.2	Commissioning the device in PROFINET	37
7.2.1	Device Model	37
7.2.2	Address setting in PROFINET	38
7.2.3	FSU – Fast Start-Up (prioritized startup)	39
7.2.4	MRP (Media Redundancy Protocol)	40
7.2.5	User data for acyclic services (IO-Link)	41
7.2.6	The IO-Link function block IOL_CALL	44
7.3	Connecting the devices to a PROFINET controller with TIA Portal	48
7.3.1	Installing the GSDML-file	49
7.3.2	Connecting the devices to the PLC	50
7.3.3	Assigning the PROFINET device name	51
7.3.4	Setting the IP address in TIA Portal	52
7.3.5	Configuring device functions	53
7.3.6	Connecting the device online with the controller	56
7.3.7	PROFINET – mapping	56
7.3.8	Using the IO_LINK_DEVICE function block in TIA Portal	57
7.4	Commissioning the devices in Modbus TCP	64
7.4.1	Implemented Modbus functions	64
7.4.2	Modbus registers	64
7.4.3	Data width	67
7.4.4	Register mapping	68
7.4.5	Error behavior (watchdog)	70
7.5	Connecting devices to a Modbus Client with CODESYS	71
7.5.1	Connecting the device to the PLC	72
7.5.2	Configuring the Network Interface	75
7.5.3	Modbus TCP Server (Slave): setting the IP address	77
7.5.4	Defining modbus channels	78
7.5.5	Going online with the PLC	80
7.5.6	Reading process data	81
7.6	Commissioning the devices in EtherNet/IP	82
7.6.1	Common EtherNet/IP features	82
7.6.2	EDS files and catalog files	82
7.6.3	QuickConnect (QC)	82
7.6.4	Device Level Ring (DLR)	83
7.6.5	Diagnostic messages via process data	84
7.6.6	EtherNet/IP standard classes	84
7.6.7	VSC-Vendor Specific Classes	105
7.7	Connecting the devices to an EtherNet/IP scanner with Studio 5000	118
7.7.1	Adding the devices from the catalog files to the new project	119
7.7.2	Configuring the device	121
7.7.3	Parameterizing the device	122
7.7.4	Going online with the PLC	123
7.7.5	Reading process data	125

7.8	Commissioning the devices in CC-Link IE Field Basic	126
7.8.1	General features CC-Link IE Field Basic.....	126
7.8.2	CSP+ files	126
7.8.3	Cyclic data transmission	127
7.8.4	Occupied Stations	128
7.8.5	Bit area.....	129
7.8.6	Word area	131
7.8.7	Parameter mapping	138
7.8.8	Acyclic communication via SLMP – supported functions	140
7.9	Connecting devices to a CC-Link IE Field Basic client with GX Works3	143
7.9.1	Register the CSP+ files in GXWorks3	144
7.9.2	Configuring the network settings	145
7.9.3	Configuring the CC-Link IE Field Basic network.....	146
7.9.4	Defining the process data mapping for CC-Link devices in the network	153
7.9.5	Going online with the PLC	154
7.9.6	Reading process data.....	155
7.10	Commissioning IO-Link devices.....	157
7.10.1	Commissioning IO-Link device-Link devices via IO-Link Device Application.....	157
7.10.2	Commissioning IO-Link devices via SIDI (PROFINET only).....	160
7.10.3	IO-Link network scan in TAS desktop.....	165
7.10.4	Commissioning IO-Link devices V1.0 (data storage)	167
7.10.5	Commissioning IO-Link devices V1.1 (data storage)	168
8	Parameterizing and configuring	170
8.1	Parameters	170
8.1.1	Adapting process data mapping	176
8.1.2	PROFINET parameters.....	177
8.2	IO-Link functions for acyclic communication.....	178
8.2.1	Port functions for Port 0 (IO-Link Master)	178
8.3	Parameterizing IO-Link devices (IO-Link Device Application)	185
9	Operating.....	186
9.1	Process input data	186
9.2	Process output data	188
9.3	LED displays	190
9.4	Software diagnostic messages.....	192
9.4.1	Status- and control word	192
9.4.2	Diagnostic telegram	193
9.4.3	PROFINET diagnostics.....	195
9.5	Using IO-Link data storage.....	197
9.5.1	Parameter "Data storage mode" = activated	197
9.5.2	Parameter "Data storage mode" = read in	199
9.5.3	Parameter "Data storage mode" = overwrite.....	199
9.5.4	Parameter "Data storage mode" = deactivated, clear.....	199
9.6	Operating IO-Link devices (IO-Link Device Application).....	200
10	Troubleshooting.....	202
10.1	Eliminate parameterization errors in the IO-Link master	202
11	Maintenance	203
11.1	Updating the firmware via TAS	203
11.2	Updating the firmware via web server	205
12	Repair	207
12.1	Returning devices	207

13 Disposal.....	207
14 Technical data.....	208
15 Turck branches — contact data	212

1 About these instructions

These instructions describe the setup, functions and use of the product and help you to operate the product according to its intended purpose. Read these instructions carefully before using the product. This will prevent the risk of personal injury and damage to property. Keep these instructions safe during the service life of the product. If the product is passed on, pass on these instructions as well.

1.1 Target groups

These instructions are written for specifically trained personnel and must be read carefully by anyone entrusted with the installation, commissioning, operation, maintenance, disassembly or disposal of the device.

When using the device in Ex areas, the user must also have knowledge of explosion protection (IEC/EN 60079-14 etc.).

1.2 Explanation of symbols

The following symbols are used in these instructions:



DANGER

DANGER indicates a hazardous situation with a high level of risk, which, if not avoided, will result in death or serious injury.



WARNING

WARNING indicates a hazardous situation with a medium level of risk, which, if not avoided, will result in death or serious injury.



CAUTION

CAUTION indicates a hazardous situation with a medium level of risk, which, if not avoided, will result in moderate or minor injury.



NOTICE

CAUTION indicates a situation which, if not avoided, may cause damage to property.



NOTE

NOTE indicates tips, recommendations and important information about special action steps and issues. The notes simplify your work and help you to avoid additional work.



MANDATORY ACTION

This symbol denotes actions that the user must carry out.



RESULT OF ACTION

This symbol denotes the relevant results of an action.

1.3 Additional documents

The following additional documents are available online at www.turck.com

- Data sheet
- EU Declaration of Conformity (current version)
- Commissioning manual IO-Link devices
- Notes on Use in Ex zone 2 and 22 (100022986)
- Approvals

1.4 Feedback about these instructions

We make every effort to ensure that these instructions are as informative and as clear as possible. If you have any suggestions for improving the design or if some information is missing in the document, please send your suggestions to techdoc@turck.com.

2 Notes on the product

2.1 Product identification

These instructions apply for the following IO-Link master modules:

- TBEN-L4-8IOL
- TBEN-L5-8IOL

2.2 Scope of delivery

The delivery consists of the following:

- TBEN-L...-8IOL
- Closure caps for M12 female connectors
- Label clips

2.3 Turck service

Turck supports you in your projects — from the initial analysis right through to the commissioning of your application. The Turck product database at www.turck.com offers you several software tools for programming, configuring or commissioning, as well as data sheets and CAD files in many export formats.

For the contact details of our branches worldwide, please see page [▶ 212].

3 For your safety

The product is designed according to state of the art technology. Residual hazards, however, still exist. Observe the following safety instructions and warnings in order to prevent danger to persons and property. Turck accepts no liability for damage caused by failure to observe these safety instructions.

3.1 Intended use

The multiprotocol I/O module TBEN-L...-8IOL is an IO-Link master according to IO-Link specification V1.1 and can be operated in the four Ethernet protocols PROFINET, Ethernet/IP, Modbus TCP and CC-Link IE Field Basic. The device detects the bus protocol automatically during the start-up.

The IO-Link master TBEN-L...-8IOL has eight IO-Link channels. Up to eight IO-Link sensors or I/O hubs with IO-Link can be connected to the M12 sockets. In addition, up to 12 digital sensors or actuators can be directly connected. When using I/O hubs, it is possible to connect up to 128 digital sensors per device.

The devices meet the requirements for passive safety Passive Sicherheit and can be used in the following applications:

- Applications up to SIL CL2 (according to EN 62061:2016, section 6.7.7)
- Applications up to Category 3 and Performance Level d (according to EN ISO 13849-1: 2016)

Installation directly in the field is possible thanks to degree of protection IP65, IP67 IP67K. Devices with the Ex marking are suitable for use in the Ex area in zone 2 and zone 22.

The device must only be used as described in these instructions. Any other use is not in accordance with the intended use. Turck accepts no liability for any resulting damage.

3.2 Foreseeable Misuse

The device is not suitable for:

- The permanent use in liquids

Modifications to the device

It is not permitted to modify the technical function or the construction of the device.

3.3 General safety instructions

- The device must only be fitted, installed, operated, parameterized and maintained by trained and qualified personnel.
- Only use the device in compliance with the applicable national and international regulations, standards and laws.
- The device meets the EMC requirements for the industrial areas. When used in residential areas, take measures to prevent radio frequency interference.
- Change the default password of the integrated web server after the first login. Turck recommends the use of a secure password.

3.4 Notes on Ex protection

- When using the device in Ex areas, the user must have knowledge of explosion protection (IEC/EN 60079-14 etc.).
- Observe national and international regulations for explosion protection.
- Only use the device within the permissible operating and ambient conditions (see certification data and Ex approval specifications).
- The document "Notes on Use in Ex Zone 2 and 22" (ID 100022986) contains the approval data for using the device in hazardous areas. Observe the requirements in the document.

3.5 Requirements for Ex approval

- Only use the device in an area with no more than pollution degree 2.
- Only disconnect and connect circuits when there is no potentially explosive atmosphere or when the power supply is switched off
- Only operate the switches when there is no potentially explosive atmosphere or when the power supply is switched off.
- Connect the metal protective cover to the equipotential bonding in the Ex area (cable cross-section: 4 mm²).
- Ensure impact resistance in accordance with EN IEC 60079-0 – alternative measures:
 - Install the device in the TB-SG-L protective housing (available in the set with Ultem window: ID 100014865) and replace the Lexan service window with the Ultem window.
 - Install the device in an area offering impact protection (e.g. in the robot arm) and attach a warning sign: "DANGER: Do not connect or disconnect circuits under live conditions. Do not actuate the switch under live conditions".
- Keep the service window of the devices closed during operation in order to comply with the IP protection.
- Do not install the device in areas critically exposed to UV light.
- Prevent risks caused by electrostatic charge.
- Provide unused male connectors with suitable sealing or blanking caps in order to ensure degree of protection IP65, IP67 or IP69K The tightening torque for the M4 screws is 0.5 Nm.

4 Product description

The devices are designed in a fully encapsulated housing with degree of protection IP65, IP67 and IP69K.

The IO-Link master module TBEN-L...-8IOL has eight IO-Link ports for connecting IO-Link devices. The IO-Link ports at the connectors C0...C3 are designed as Class A ports. The IO-Link ports at the connectors C4...C7 are designed as Class B ports. In addition to the eight IO-Link-channels, four universal digital DXP channels (PNP) are available. The eight IO-Link channels can be parameterized independently of each other and operated either in IO-Link mode or in SIO mode (DI).

With Turck's "Simple IO-Link Device Integration (SIDI)", IO-Link devices can be directly integrated into PROFINET via the GSDML file of the TBEN-L...-8IOL.

The four universal digital channels are designed as DXP-channels and can therefore be parameterized as in- or output.

4-pin (TBEN-L4) or 5-pin (TBEN-L5) 7/8" connectors are available for connecting the supply voltage.

Two device types are available:

- TBEN-L4-8IOL
- TBEN-L5-8IOL

4.1 Device overview

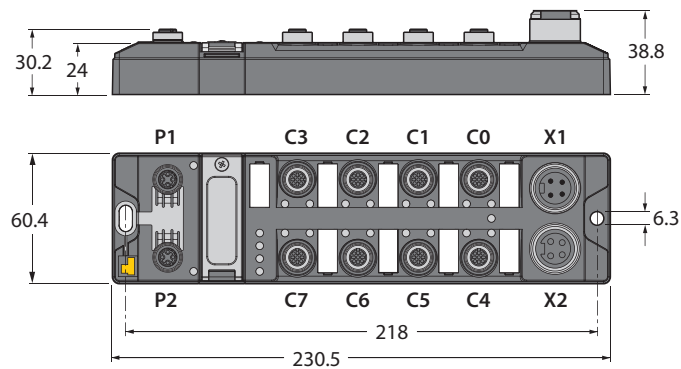

Fig. 1: Dimensions TBEN-L4-8IOL

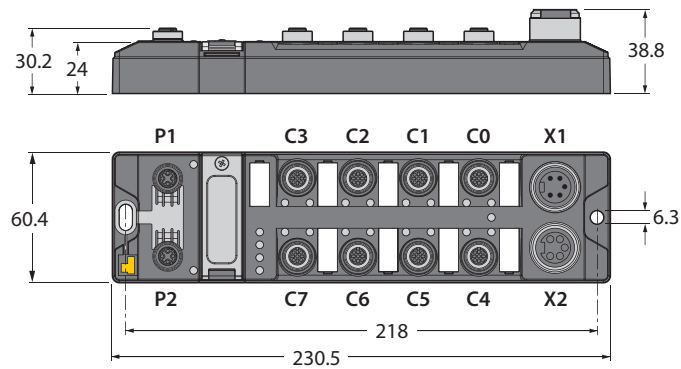

Fig. 2: Dimensions TBEN-L5-8IOL

Connector	LED	Channel	Function	Auxiliary voltage
C0	0	Ch0	IO-Link port 1 (Class A)	VAUX1
	1	Ch1	DXP1	
C1	2	Ch2	IO-Link port 2 (Class A)	VAUX1
	3	Ch3	DXP3	
C2	4	Ch4	IO-Link port 3 (Class A)	VAUX1
	5	Ch5	DXP5	
C3	6	Ch6	IO-Link port 4 (Class A)	VAUX1
	7	Ch7	DXP7	
C4	8	Ch8	IO-Link port 5 (Class B)	VAUX1
	9	Ch9		VAUX2
C5	10	Ch10	IO-Link port 6 (Class B)	VAUX1
	11	Ch11		VAUX2
C6	12	Ch12	IO-Link port 7 (Class B)	VAUX1
	13	Ch13		VAUX2
C7	14	Ch14	IO-Link port 8 (Class B)	VAUX1
	15	Ch15		VAUX2

4.1.1 Block diagram

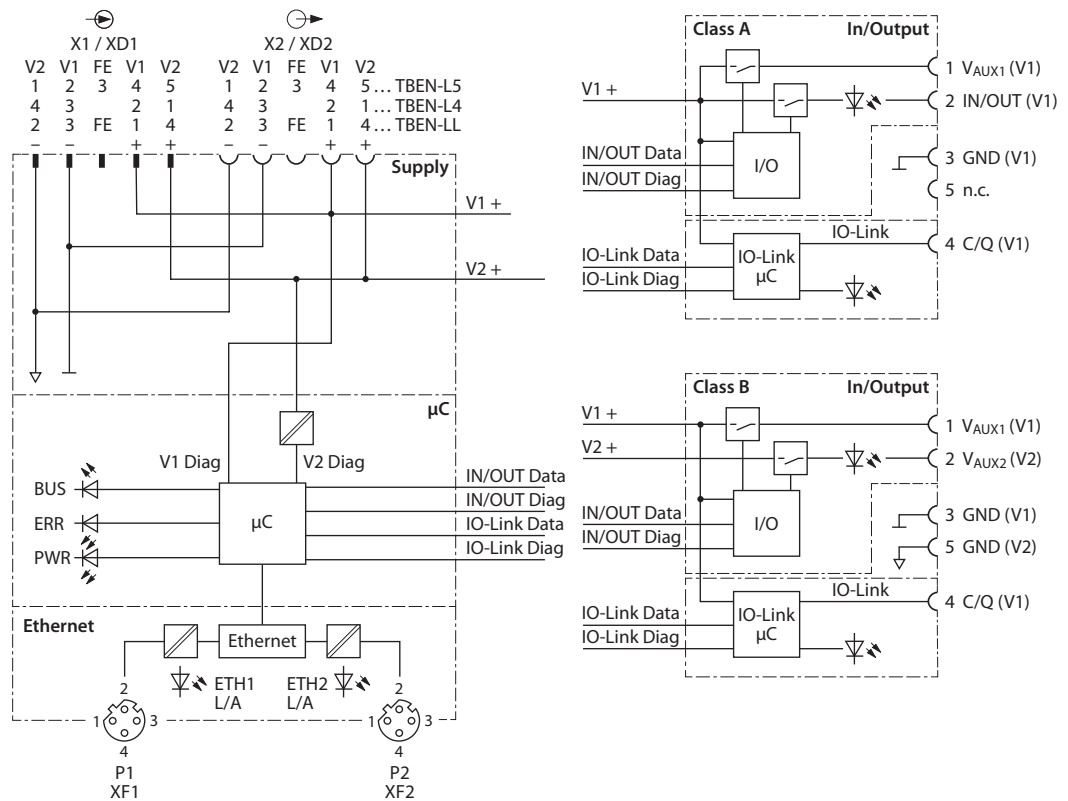

Fig. 3: Block diagram

4.1.2 Operating elements

The device has the following operating elements:

- Rotary coding switches for adjusting the network settings
- Reset button for executing a device restart

4.1.3 Indication elements

The device is provided with the following LEDs:

- Power supply voltage
- Group and bus error
- Status
- Diagnostics

4.2 Properties and features

- Fiber-glass reinforced housing
- Shock and vibration tested
- Fully potted module electronics
- Degree of protection IP65/IP67/IP69K
- UV-resistant according to DIN EN ISO 4892-2
- Metal connectors
- Separated power groups for safety shutdown
- Integrated Ethernet-switch for building up a line-topology
- Transmission speed 10 Mbps/100 Mbps
- Integrated web server
- 4 IO-Link ports Class A and 4 IO-Link ports Class B
- 4 universal DXP channels (PNP)
- Multiprotocol: PROFINET device, EtherNet/IP device, Modbus TCP server, CC-Link IE Field Basic server
- PROFINET:
 - Conformance Class B PA
 - Simple IO-Link Device Integration (SIDI)
 - Conformity according to PROFINET specification V2.35
 - System redundancy S2
 - Network load class 3
- EtherNet/IP:
 - Support of IO-Link parameter object for asynchronous services (IO-Link-CALL)
 - Predefined in- and output assemblies

4.3 Operating principle

The IO-Link master module TBEN-L...-8IOL connects IO-Link sensors and actuators with the higher-level control system. The device has an Ethernet interface and fieldbus-independent I/O electronics with IO-Link master functionality (Class A and Class B ports). Via the Ethernet interface, the IO-Link master is connected to an (existing) Ethernet network as an EtherNet/IP device, Modbus TCP server, PROFINET device or CC-Link IE Field Basic server. During operation, the process data is exchanged between Ethernet and IO-Link. In addition the devices can process signals from sensors and actuators via four configurable digital channels.

4.4 Functions and operating modes

4.4.1 Multiprotocol technology

The device can be used in the following Ethernet protocols:

- PROFINET
- EtherNet/IP
- Modbus TCP
- CC-Link IE Field Basic

The required Ethernet protocol can be detected automatically or determined manually.

Automatic protocol detection

A multiprotocol device can be operated without intervention of the user (which means, without changes in the parameterization) in all of the three Ethernet protocols mentioned.

During the system start-up phase (snooping phase), the module detects which Ethernet protocol requests a connection to be established and adjusts itself to the corresponding protocol. After this an access to the device from other protocols is read-only.

Manual protocol selection

The user can also define the protocol manually. In this case, the snooping phase is skipped and the device is fixed to the selected protocol. With the other protocols, the device can only be accessed read-only.

Protocol-dependent functions

The device supports the following Ethernet protocol-specific features:

PROFINET

- Fast Start Up (FSU), prioritized start-up, only digital I/O channels
- Topology detection
- Address allocation with LLDP
- Media redundancy protocol (MRP)
- S2 redundancy

EtherNet/IP

- QuickConnect (QC), only digital I/O channels
- Device Level Ring (DLR)

Ethernet ports used

Port	Protocol
00022	SFTP
00053	DNS TCP
00067	DHCP
00080	HTTP
00093	PROFINET DCP
00502	Modbus TCP
58554	Turck Services

4.4.2 IO-Link channels

The IO-Link master module TBEN-L...-8IOL has four Class A IO-Link ports (slots C0...C3) and four Class B IO-Link ports (slots C4...C7).

The eight IO-Link channels can be parameterized independently of each other and operated either in IO-Link mode or in SIO mode (DI).

Simple IO-Link Device Integration (SIDI)

Turck's Simple IO-Link Device Integration (SIDI) simplifies the handling of IO-Link devices in PROFINET engineering systems. The IO-Link devices are integrated in the GSDML file of the master, which allows the user to select the devices from the device library (for example in TIA Portal) like sub modules on a modular I/O system and integrate them into the project. Plain-text access to all device properties and parameters is possible. IO-Link device-specific data such as measuring ranges, switching points, pulse rates, etc. can be set directly in the engineering system without programming or additional software [► 160].



NOTE

Data storage [► 197] is not possible when configuring IO-Link devices with SIDI.

IO-Link-Device-Application

The IO-Link Device Application is a browser-based configuration tool and called from the web server of the IO-Link master module.



NOTE

To be able to call up the IO-Link Device Application, a login to the web server of the IO-Link master is required [► 36].

The IO-Link Device Application allows access to the plain text of all relevant IO-Link device parameters and supports and simplifies the parameterization, commissioning and maintenance of IO-Link devices.

IO-Link device-specific information is made available directly in the IO-Link master. The IO-Link device-specific information is loaded into the IO-Link master and interpreted by the master. IO-Link events, diagnostics and process data of the IO-Link devices can thus be interpreted directly in the web server of the IO-Link master according to the specific device. In addition, the IO-Link Device Application provides information on the process data structure and pin assignment of the connected IO-Link devices.

The IO-Link Device Application supports the "Operator", "Maintenance" and "Specialist" user roles specified by the IO-Link specification. The specific access rights for these user roles are defined by the IODD of the IO-Link devices.

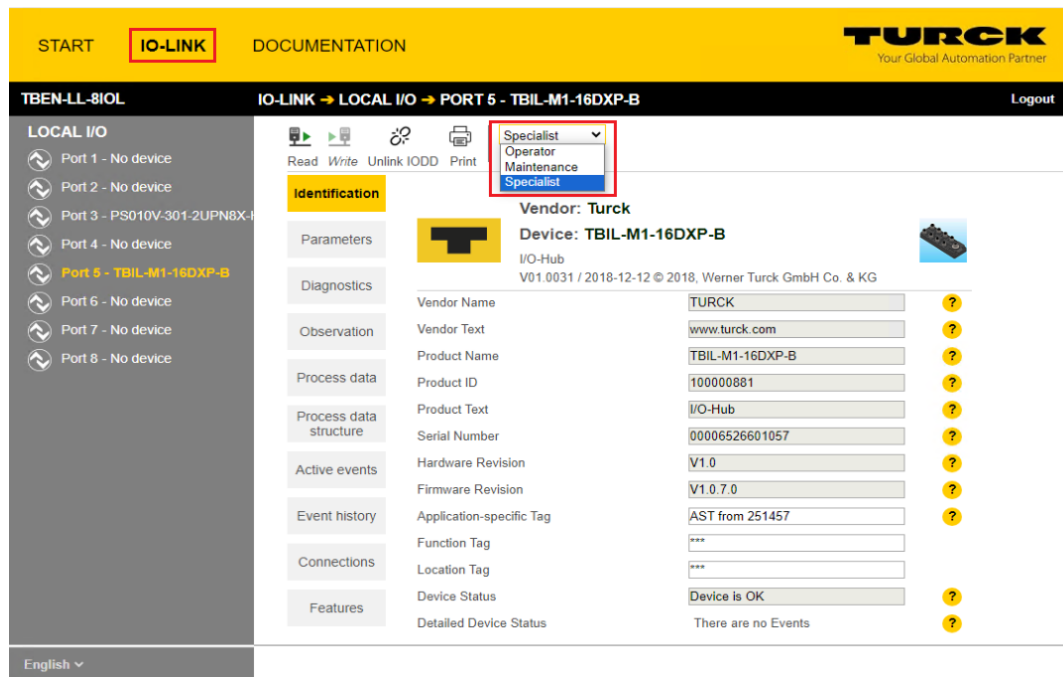

Fig. 4: IO-Link Device Application (using the TBEN-LL-8IOL as an example)

4.4.3 Universal digital channels – functions

The device has four universal digital channels that can be used as inputs or outputs without configuration. Up to four 3-wire PNP sensors or four PNP DC actuators can be connected. The maximum output current per output is 2 A.

4.4.4 Passive safety

Due to the galvanic isolation of load and operating voltage, the design of the devices allows the fault exclusion of voltage carry-over to safely disconnected equipment with a single fault safety of category 3 for safety functions up to Performance Level d. The maximum achievable Safety Integrity Level (SIL CL) is SIL2.

Further technical requirements on other system components for compliance with the respective required performance level or safety integrity level remain unaffected.

4.4.5 Backplane Ethernet Extension Protocol (BEEP)

BEEP (Backplane Ethernet Extension Protocol) is a technology that is available in many digital Turck multi protocol block I/O modules. BEEP allows a network, of up to 33 participants (one controller and 32 devices) or 480 bytes of data, to appear to the PLC as a single device on a single connection using a single IP address.

Detailed information about BEEP can be found in the document "BEEP – Backplane Ethernet Extension Protocol" (ID 100002454).

4.4.6 Turck Field Logic Controller function (FLC ARGEE)

The device supports logic processing via the “Turck Field Logic Controller (FLC ARGEE)” function. This enables the device to implement small to medium-sized control tasks in order to reduce the load of the central controller. The FLCs can be programmed in the ARGEE engineering environment.

The ARGEE programming software can be downloaded free of charge from www.turck.com.

The “SW_ARGEE_Environment_Vx.x.zip” file also contains the documentation for the programming environment as well as the software.

4.5 Possible Ethernet network structures

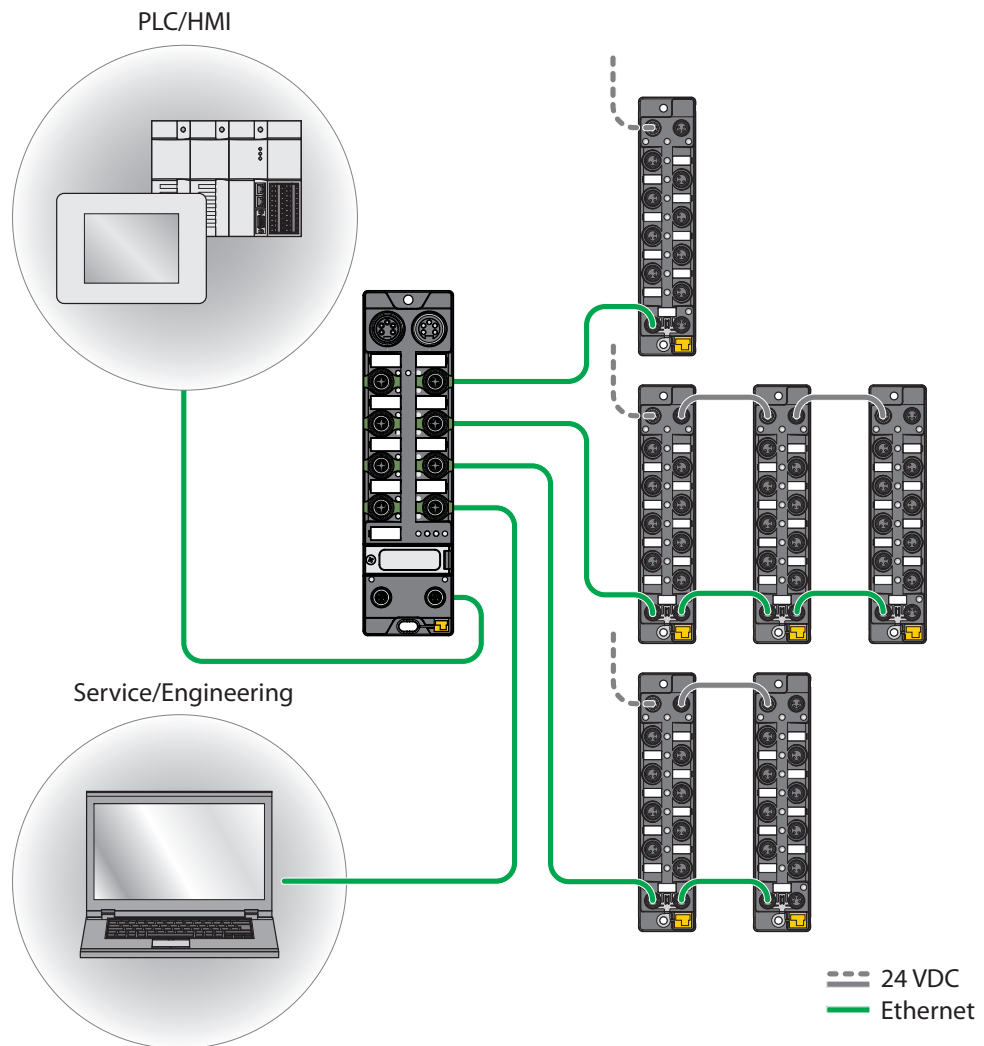

Fig. 5: Network structure, example 1

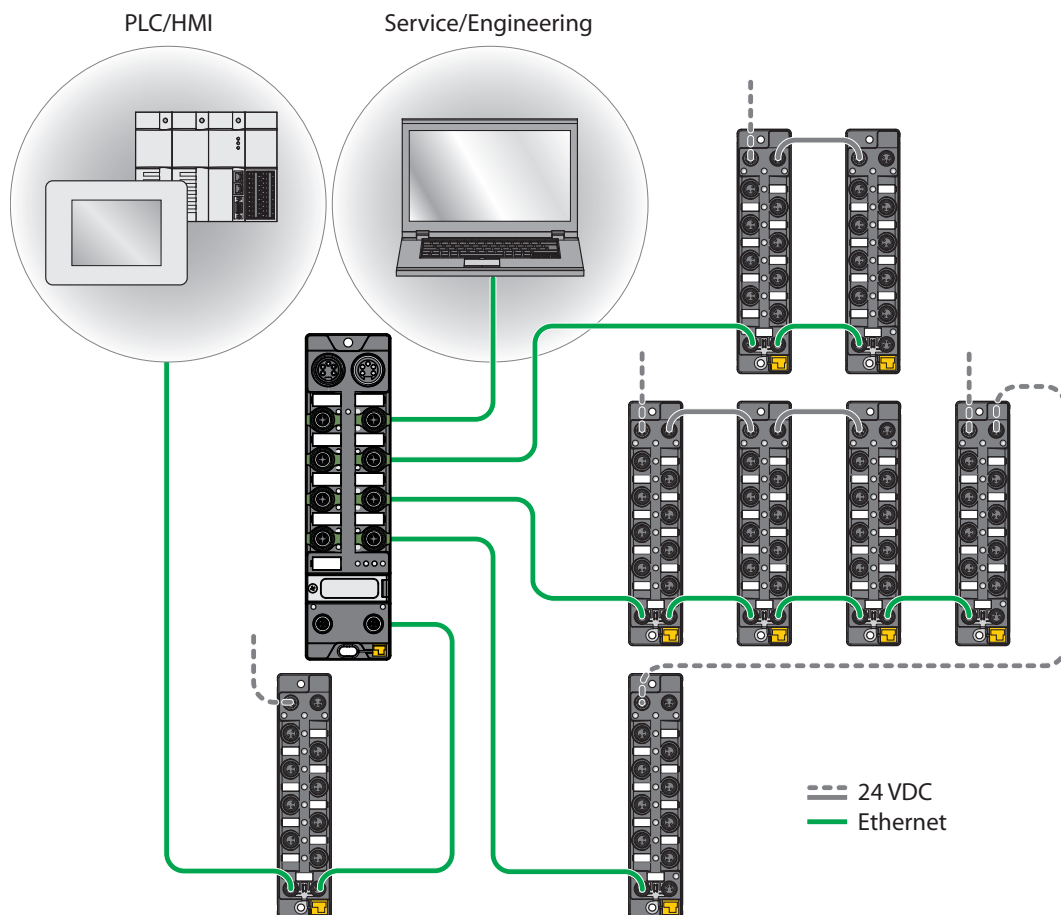

Fig. 6: Network structure, example 2

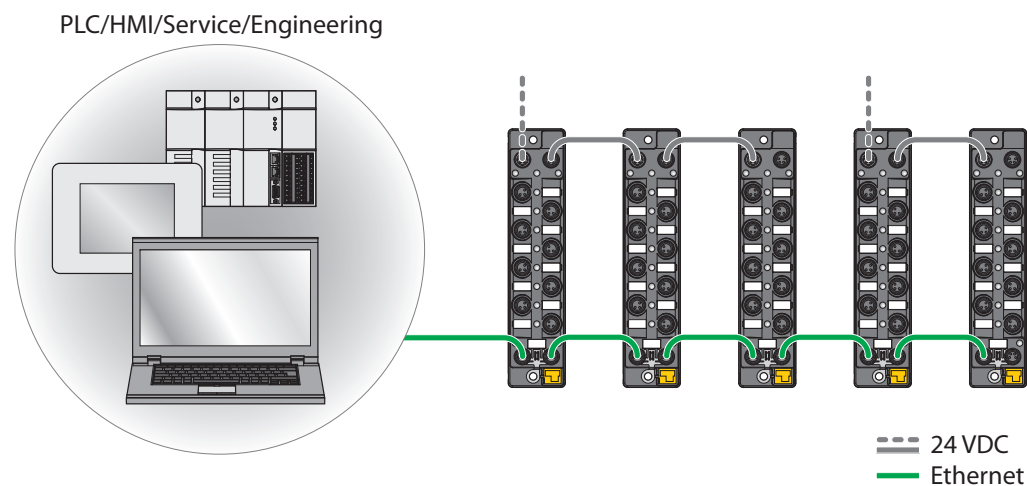

Fig. 7: Network structure, example 3

4.5.1 Ethernet daisy chain - max. number of connected modules

Prerequisites:

- Optimized network: only TBEN modules in the daisy chain, no additional switches, no third-party devices
- Exchange of pure cyclical process data, no acyclical data

Cycle time	Maximum number of TBEN modules
1 ms	21
2 ms	42



NOTE

Deviations from the specification above may lead to a reduction of possible TBEN modules connected to one daisy chain.

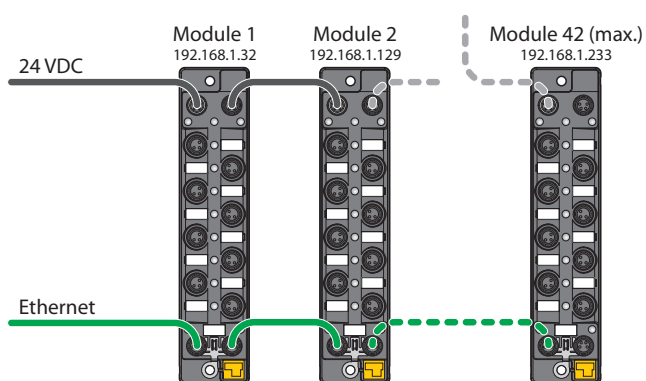

Fig. 8: Daisy chain

5 Installing

5.1 Installing a device in zone 2 and zone 22

The devices can be used in combination with the TB-SG-L (ID 100014865) protective housing set in zone 2 and zone 22.



DANGER

Potentially explosive atmosphere
Risk of explosion due to spark ignition
Operation in zone 2 or zone 22:

- ▶ Only install the device if there is no potentially explosive atmosphere present.
- ▶ Observe the requirements for Ex approval.

- ▶ Screw on the housing. Use a Torx T8 screwdriver.
- ▶ Replace the service window with the supplied Ultem window.
- ▶ Place the device on the base plate of the protective housing fasten both together on the mounting plate [▶ 21].
- ▶ Connect the device, [▶ 25].
- ▶ Fit the housing cover and screw on as shown in the following figure. The tightening torque for the Torx T8 screw is 0.5 Nm.

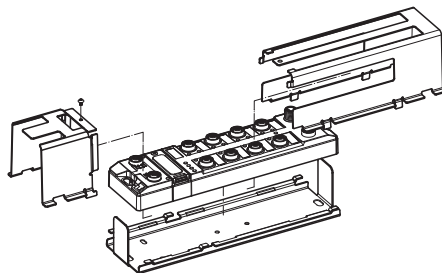

Fig. 9: Installing the device in the TB-SG-L protective housing

5.2 Mounting onto a mounting plate



NOTICE

Mounting on uneven surfaces

Device damage due to stresses in the housing

- ▶ Attach the device to the mounting plate with two M6 screws.

- ▶ Attach the module to the mounting surface with two M6 screws. The maximum tightening torque for the screws is 1.5 Nm.
- ▶ Optional: Ground the device.

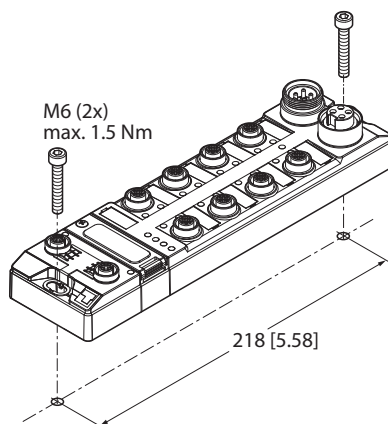

Fig. 10: Mounting the device onto a mounting plate

5.3 Outdoor device installation

The device is UV resistant in accordance with DIN EN ISO 4892-2. Direct sunlight may cause material wear and changes in color. The mechanical and electrical properties of the device are not impaired.

- ▶ To prevent material wear and color changes: Protect the device from direct sunlight with protective panels.

5.4 Grounding the device

5.4.1 Equivalent wiring diagram and shielding concept

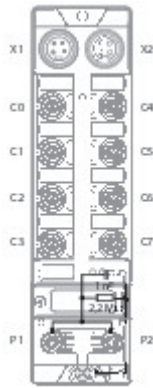

Fig. 11: TBEN-L4-8IOL – equivalent wiring diagram and shielding concept



Fig. 12: TBEN-L5-8IOL – equivalent wiring diagram and shielding concept

5.4.2 Shielding of the fieldbus and I/O level

The fieldbus and the I/O level of the modules can be grounded separately.

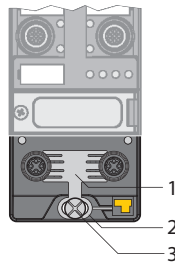

Fig. 13: Grounding clip (1), grounding ring (2) and metal screw (3)

The grounding ring (2) is the module grounding. The shielding of the I/O level is permanently connected to the module grounding. The module grounding is only connected to the reference potential of the installation when the module is mounted.

I/O level shielding

In the case of direct mounting on a mounting plate, the module grounding is connected to the reference potential of the system via the metal screw in the lower mounting hole (3). If module grounding is not desired, the electrical connection to the reference potential must be interrupted, e.g. by using a plastic screw.

Fieldbus level shielding

The grounding of the fieldbus level can either be connected directly via the grounding clip (1) or connected and routed indirectly via an RC element to the module grounding. If the grounding is to be routed via an RC element, the grounding clip must be removed.

In the delivery state, the grounding clip is mounted.

5.4.3 Disconnecting the direct grounding of the fieldbus level: removing the grounding clip

- ▶ Use a flat screwdriver to slide the grounding clip forward and remove it.

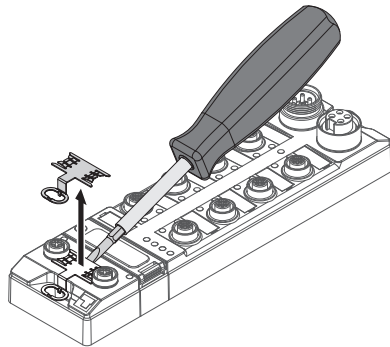

Fig. 14: Removing the grounding clamp

5.4.4 Grounding the fieldbus level directly: inserting the grounding clip

- ▶ Place the grounding clip between the fieldbus connectors by using a screwdriver in such way that the clip contacts the metal housing of the connectors.
- ▶ The shielding of the fieldbus cables is connected to the grounding clip.

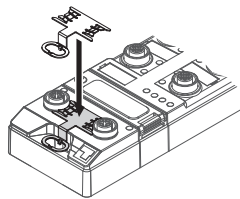

Fig. 15: Mounting the grounding clip

5.4.5 Grounding the device – mounting on a mounting plate

- ▶ For mounting onto a mounting plate: Fix the device with a metal screw through the lower mounting hole.
- ⇒ The module grounding is connected to the reference potential of the installation via the metal screw.
- ⇒ With mounted grounding clip: The shielding of the fieldbus and the module grounding are connected to the reference potential of the installation.

6 Connecting



NOTICE

Penetration of liquids or foreign objects due to leaking connections

Loss of degree of protection IP65/IP67/IP69K possible

- ▶ Tighten M12 male connectors with a tightening torque of 0.6 Nm.
 - ▶ Tighten 7/8" male connectors with a tightening torque of 0.8 Nm.
 - ▶ Only use accessories that guarantee the protection class.
 - ▶ Provide unused male connectors with suitable sealing or blanking caps. The tightening torque for the M4 screws is 0.5 Nm.
-

6.1 Connecting a device in zone 2 and zone 22



DANGER

Explosive atmosphere

Explosion due to ignitable sparks

For use in Zone 2 and Zone 22:

- ▶ Only disconnect and connect circuits when there is no potentially explosive atmosphere or when the power supply is switched off.
 - ▶ Only use connecting cables that are approved for use in potentially explosive atmospheres.
 - ▶ Use all connectors or seal them with screw caps or blind caps. The tightening torque for the screw caps is 0.5 Nm.
 - ▶ Observe requirements for Ex approval.
-

6.2 Connecting the device to Ethernet

For the connection to Ethernet the device has an integrated auto-crossing switch with two 4-pin M12 x 1-Ethernet-connectors. The maximum tightening torque is 0.6 Nm.

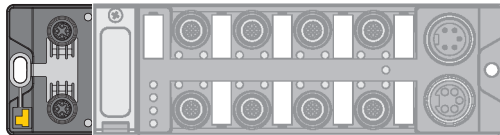

Fig. 16: M12 Ethernet connector

- ▶ Connect the device to Ethernet according to the pin assignment below.
- ▶ Provide unused male connectors with suitable sealing or blanking caps. The tightening torque for the M4 screws is 0.5 Nm.



Fig. 17: Pin assignment Ethernet connectors

6.2.1 Applications with QuickConnect (QC) and Fast Start Up (FSU)

- ▶ Do not use crossover cables in applications with QuickConnect (QC) and Fast Start Up (FSU) applications.
- ▶ Connect incoming Ethernet cables to P1.
- ▶ Connect outgoing Ethernet cables to P2.

6.3 Connecting the power supply

The device is provided with two 7/8" connectors for connecting the power supply. The plug connectors are 4-pin (TBEN-L4) or 5-pin (TBEN-L5) connectors. V1 and V2 are electrically isolated from each other. The maximum tightening torque is 0.8 Nm.

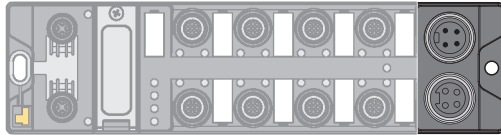

Fig. 18: TBEN-L4... – 7/8" connector for connecting the power supply

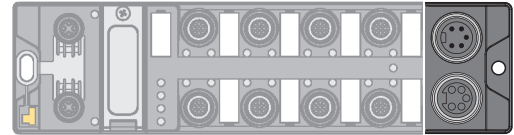

Fig. 19: TBEN-L5... – 7/8" connector for connecting the power supply

- ▶ Connect the device to the power supply according to the pin assignment below.
- ▶ Provide unused male connectors with suitable sealing or blanking caps. The tightening torque for the M4 screws is 0.5 Nm.

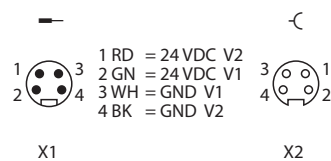

Fig. 20: TBEN-L4... – pin assignment of the power supply connections

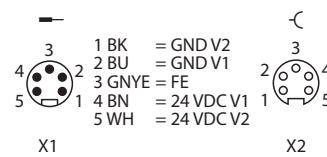

Fig. 21: TBEN-L5... – pin assignment of the power supply connections

Connector	Function
X1	Power feed
X2	Continuation of the power to the next node



NOTE

The system voltage (V1) and the load voltage (V2) are supplied and monitored separately. If the voltage goes below the permissible lower limit, the connectors are disconnected according to the supply concept of the module type. If V2 goes below the permissible minimum voltage, PWR LED changes from green to red. If V1 goes below the permissible minimum, the PWR LED goes out.

6.3.1 Supply concept

The device is supplied via two separate voltages V1 and V2.

The I/O-channels are therefore consequently separated into the different potential groups "detachable I/O" (supplied through V2) and "non-detachable" I/O (supplied through V1). This allows a safety shutdown of parts of an installation via emergency-off circuits.

V1 = supply of the module electronics and the respective slots

V2 = supply of the respective connectors (can be switched-off separately)

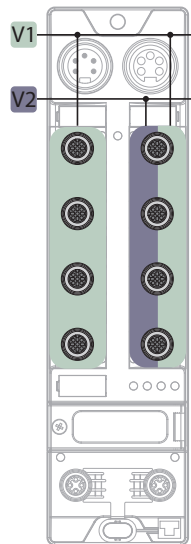

Fig. 22: Supply TBEN-L...-8IOL

6.4 Connecting IO-Link devices and digital sensors

The device has eight M12 female connectors for connecting IO-Link devices and digital sensors and actuators. The maximum tightening torque is 0.8 Nm.



NOTICE

Wrong supply of IO-Link devices

Damage to the device electronics

- ▶ Only supply IO-Link devices with the voltage provided at the IO-Link master module.

Class A ports (C0...C3)

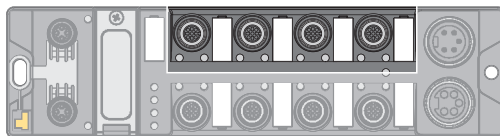

Fig. 23: M12 connectors, IO-Link master ports, Class A

- ▶ Connect the sensors and actuators to the device according to the pin assignment.

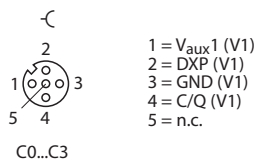

Fig. 24: Pin assignment of IO-Link master ports, Class A, C0...C3

Turck recommends the use of 3-wire cables when connecting:

- pure Class A devices without additional output on pin 2.
- IO-Link devices with additional analog output on pin 2, since an analog signal on pin 2 of the Class A ports can cause interference with IO-Link communication.

Class B ports (C4...C7)

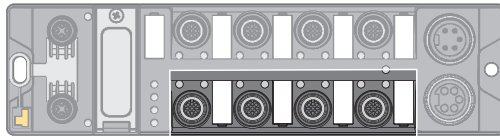

Fig. 25: M12 connectors, IO-Link master ports, Class B

- ▶ Connect the sensors and actuators to the device according to the pin assignment.

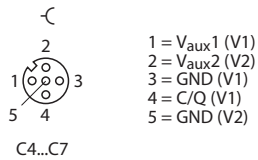

Fig. 26: Pin assignment of IO-Link master ports, Class B, C4...C7



NOTICE

Connection of Class A devices to Class B ports

Loss of the galvanic isolation with Class A devices at pin 2 and 5

- ▶ Only use Class A devices with signals on pin 1, pin 3 and pin 4 at Class B ports.

7 Commissioning

7.1 Adjusting network settings and operation mode



NOTE

Changes to network settings and operating mode are only applied after restarting the device.

Adjusting network settings

The network settings can be adapted via three rotary coding switches on the device, via TAS (Turck Automation Suite), the web server, the DTM a DHCP server or PROFINET DCP.

The setting is made during commissioning of the device and is necessary to establish a connection between the PLC and the device.

Configuring the operating mode

The operating mode of the device (Rotary, BootP, PGM-DHCP etc.) can only be adjusted using the decimal rotary coding switches on the device.

7.1.1 Adjusting network settings and operation mode via rotary coding switches

The switches are located under a service window cover together with the SET button.

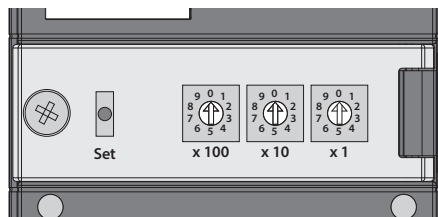

Fig. 27: Service window

- ▶ Open the service window.
- ▶ Set the rotary coding switch to the desired mode according to the table below.
- ▶ Carry out voltage reset.
- ▶ NOTICE! IP65, IP67 or IP69K protection is not guaranteed when the service window above the rotary coding switches is opened. Device damage through penetrating foreign objects or liquids is possible. Tightly close the service window.

Switch positions

The network settings of the device depend on the selected mode. Changes to the settings become active after a voltage reset.

Switch settings 000 and 900 are no operation modes. After each reset of the device to the default values, the setting of an operating mode is necessary.

Switch position	Mode	Description
000	Network reset	The Network reset resets the following the network settings to the default values: IP address: 192.168.1.254 Subnet mask: 255.255.255.0 Gateway: 192.168.1.1
1...254	Rotary	In rotary mode (static rotary), the last byte of the IP address can be set manually at the gateway. The other network settings are stored in the non-volatile memory of the gateway and cannot be changed in rotary mode. Addresses from 1...254 can be set.
300	BootP	In BootP mode, the network settings are automatically assigned by a BootP server in the network. The subnet mask assigned by the BootP server and the default gateway address are stored non-volatile in the memory of the gateway.
400	DHCP	In DHCP mode, the network settings are automatically assigned by a DHCP server in the network. The subnet mask assigned by the DHCP server and the default gateway address are stored non-volatile in the memory of the gateway, DHCP supports three mechanisms for IP address allocation: <ul style="list-style-type: none"> ■ Automatic address assignment: The DHCP server assigns a permanent IP address to the client. ■ Dynamic address assignment: The IP address assigned by the server is only reserved for a certain period of time. After this time has elapsed or after the explicit release by a client, the IP address is reassigned. ■ Manual address assignment: A network administrator assigns an IP address to the client. In this case, DHCP is only used to transmit the assigned IP address to the client.
500	PGM	In PGM mode, the complete network settings can be assigned manually via TAS (Turck Automation Suite), the DTM or a web server. The data are stored non-volatile in the device.
600	PGM-DHCP	In PGM-DHCP mode, the device is initially a DHCP client and sends DHCP requests until it is assigned a fixed IP address. The DHCP client is automatically deactivated as soon as the device has received an IP address via TAS (Turck Automation Suite), the DTM or the web server. The data are stored non-volatile in the device. In PROFINET: If a DHCP server is used in the network, problems may occur when assigning the IP address, as in this case both the DHCP server and the PROFINET controller (via DCP) attempt to assign the IP address.

Switch position	Mode	Description
701...899	Name	<p>The "Name" mode is used to set the DNS name of the device in Ethernet/IP networks. This mode is mainly used for DNS-based addressing in Schneider Electric controllers. The IP address is assigned automatically.</p> <p>The devices are addressed via the prefix "TBEN" and the address set on the rotary coding switches as follows:</p> <ul style="list-style-type: none">■ Switch position 701: TBEN_701...■ Switch position 899: TBEN_899
900	Factory reset	<p>The factory reset resets all settings to the default values:</p> <ul style="list-style-type: none">■ Network setting (IP address, subnet mask, gateway)■ PROFINET device name■ Device parameters

7.1.2 Adjusting network settings via TAS (Turck Automation Suite)

In the delivery state the device has the IP address 192.168.1.254. The IP address can be set via TAS (Turck Automation Suite). TAS is available free of charge at www.turck.com.

- ▶ Connect the device to a PC via the Ethernet interface.
- ▶ Open TAS.
- ▶ Click **Scan network**.

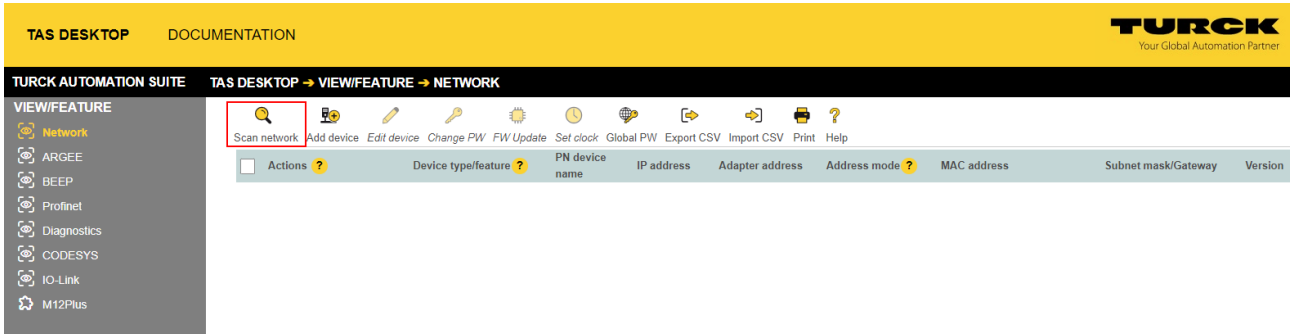

Fig. 28: Home screen in TAS

⇒ TAS shows the connected devices.

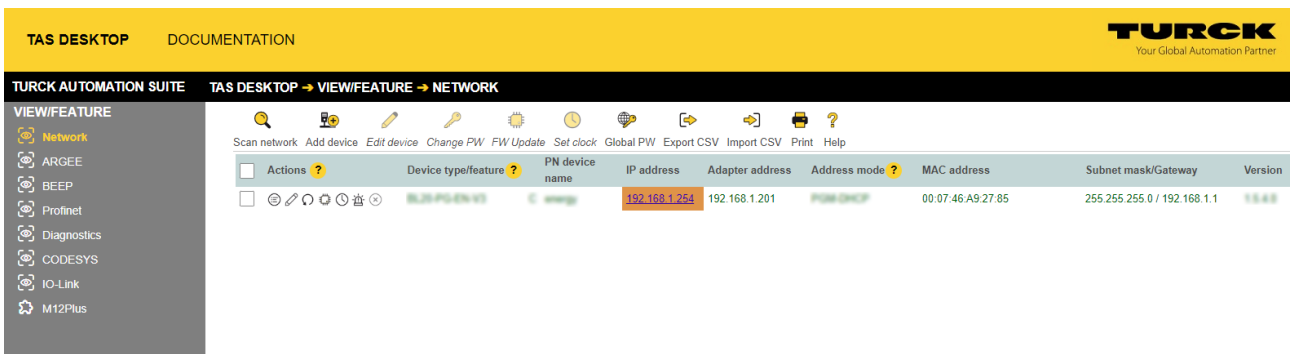

Fig. 29: Found devices in TAS

- ▶ Select the relevant device (check box).
- ▶ Click **Edit device**.

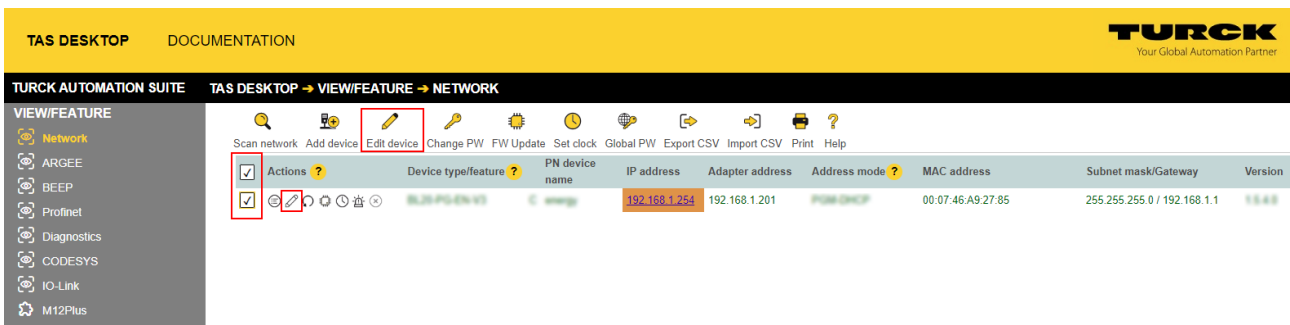

Fig. 30: Selecting the device in TAS



NOTE

By clicking on the IP address of the device, the configuration view of the device can be opened either in TAS or on the device website.

- ▶ Change the device name, the IP address and the network mask if necessary.
- ▶ Save changes by clicking on **APPLY** .

Edit network settings

PN device name	<input type="text"/>
IP address	<input type="text" value="192.168.1.254"/>
Default gateway	<input type="text" value="192.168.1.1"/>
Subnet mask	<input type="text" value="255.255.255.0"/>

Take care, that the IP address isn't used by any other devices or switches!

APPLY **CANCEL**

Fig. 31: Changing network settings in TAS

7.1.3 Adjusting network settings via the web server

A login is required to edit settings via the web server. The default password is "password".



NOTE

Turck recommends changing the password after the first login for security reasons.

- ▶ Open the device's web server.
- ▶ Enter **Username** and **Password**.
- ▶ Click **Login**



NOTE

To be able to adjust the network settings via the web server, the device must be in PGM mode.

- ▶ Click **TBEN-L... → Parameter → Network**.
- ▶ Adjust the network settings.
- ▶ Write the changes into the device via **SET NETWORK CONFIGURATION**.

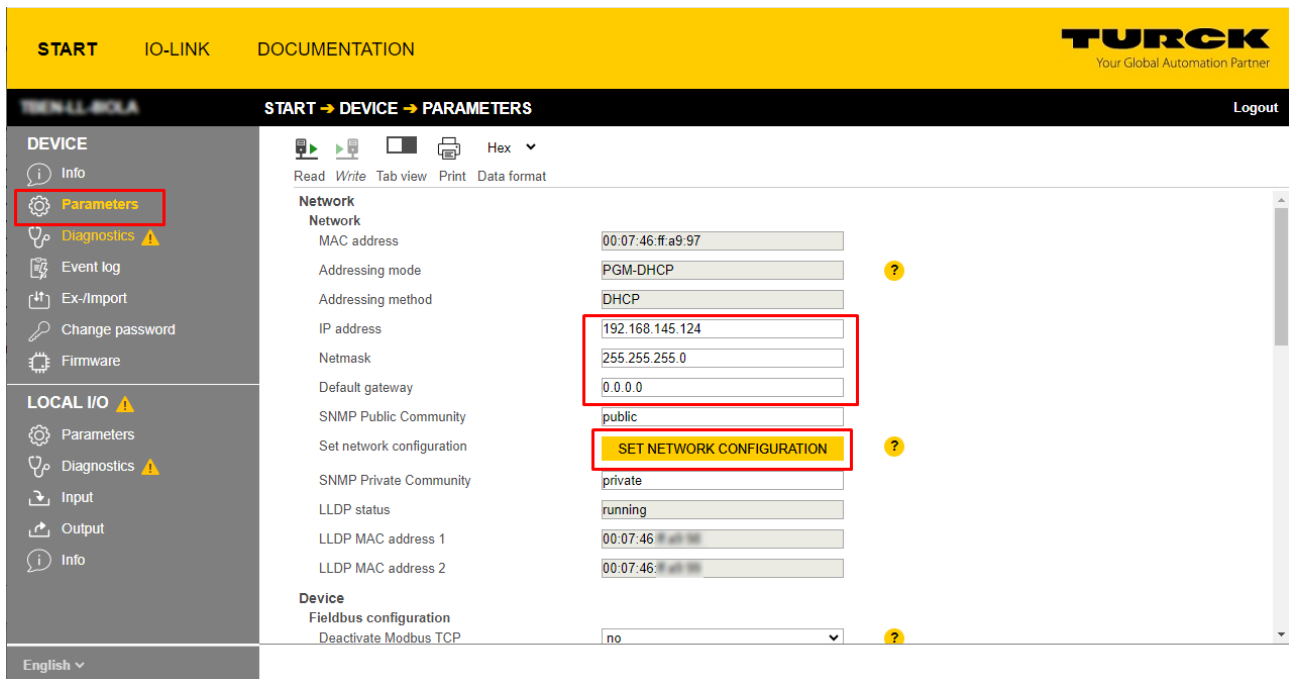

Fig. 32: Web server – adjusting network settings

7.2 Commissioning the device in PROFINET

7.2.1 Device Model

The TBEN-L...-8IOL has eight parameterizable IO-Link channels, which can also be used as digital channels in SIO mode, and 8 universal I/O channels (DXP).

In addition to that, five virtual slots are provided via GSDML in PROFINET. Those channels are used to map the different diagnostic and status (IO-Link and VAUX diagnostics, IO-Link-Events, module status) data into the master's process image .



NOTE

The GSDML file also contains a one-slot device for the use of devices in engineering environments that are optimized for the use of devices with few slots (e.g. DeltaV).

Module	Rack	Slot	I address	Q address	Type	Article no.
turck-tben-ll-8iol	0	0			TBEN-LL-8IOL	100003910
PN-IO	0	0 X1			turck-tben-ll-8iol	
LL-Basic_1	0	Basic			LL-Basic	
IN 32 BYTE (Octet)_1	0	IO-Link Port 1			IN 32 BYTE (Octet)	
FS+ (FS 100-300L-30-2UPN8...	0	IO-Link Port 2			FS+ (FS 100-300L-3...	
CMVT-QR20-IOLX3-xxxx (IS...	0	IO-Link Port 3			CMVT-QR20-IOLX3-...	
B2N360-Q42 (DI)_1	0	IO-Link Port 4			B2N360-Q42 (DI)	
VMPAL-EPL-IPO32_1	0	IO-Link Port 5 (Class B)			VMPAL-EPL-IPO32	
IN 2 WORD/OUT 2 WORD_1	0	IO-Link Port 6 (Class B)			IN 2 WORD/OUT 2 ...	
DF-G2-KD-xx_1	0	IO-Link Port 7 (Class B)			DF-G2-KD-xx	
IN 16 BIT/OUT 16 BIT_1	0	IO-Link Port 8 (Class B)			IN 16 BIT/OUT 16 BIT	
LL-Diagnostics_1	0	Diagnostics			LL-Diagnostics	
IO-Link Events_1	0	IO-Link Events			IO-Link Events	
LL-VAUX control 16CH_1	0	VAUX control			LL-VAUX control 1...	
Device status_1	0	Device status			Device status	

Fig. 33: TBEN-L...-8IOL – slot overview in TIA-Portal (example)

Slot	Data
Basic	Data of the DXP channels and data valid signal
IO-Link-port...	IO-Link ports for the configuration with specific IO-Link devices or for generic configuration
Diagnostics	One slot each for diagnostics and status
IO-Link Events	
VAUX Control	
Device status	Module status, status-word of the device

7.2.2 Address setting in PROFINET

In IP-based communication, the field devices are addressed by means of an IP address. PROFINET uses the Discovery and Configuration Protocol (DCP) for IP assignment.



NOTE

DCP is a standard protocol and can also be used outside PROFINET, e.g. in IPC operating systems (Windows, Linux). DCP is available in tool packages such as WinPcap, Npcap, Wireshark etc.

When delivered, each field device has, among other things, a MAC address. The MAC address is sufficient to give the respective field device a unique name.

The address is assigned in two steps:

- Assignment of a unique plant specific name to the respective field device
- Assignment of the IP address from the IO-Controller before the system start-up based on the plant-specific (unique) name

PROFINET naming convention

The names are assigned via DCP. The device name is checked for correct spelling during input. The following rules apply to the use of the device name in accordance with PROFINET specification V2.3.

- All device names must be unique.
- Maximum name size: 240 characters
- Allowed:
 - Lower case letters a...z
 - Numbers 0...9
 - Hyphen and dot
- The name may consist of several components separated by a period. A name component, i.e. a string between two dots, may be a maximum of 63 characters long.
- The device name must not start or end with a hyphen.
- The name must not begin with or "port-xyz" (y...z = 0...9).
- The name must not have the form of an IP address (n.n.n.n, n = 0...999).
- Do not use special characters.
- Do not use capital letters.

7.2.3 FSU – Fast Start-Up (prioritized startup)

FSU enables a PLC to build up connections to PROFINET nodes in less than 500 ms after switching-on the network power supply (V1). The fast start-up is necessary for fast tool changing applications at robot arms for example in the automobile industry.



NOTE

For the correct cabling in FSU applications please observe the note in the chapter "Connecting the Device to Ethernet" [▶ 26].

Fast Start Up (FSU) TBEN

The TBEN-L...-8IOL supports the prioritized start-up (FSU). After FSU has been completed, only the process data for the digital I/O channels (pin 2) of C0...C7 are available. IO-Link communication is set up according to the IO-Link standard mechanisms.

Activating FSU

In order to enable FSU, the fieldbus nodes have to be configured respectively, for example in TIA-Portal (Siemens).

Auto negotiation: deactivated

Transmission medium/duplex: Set to a fixed value

- ▶ During configuration, please observe that the neighboring devices do also support FSU and that the settings for the ports of neighboring devices are identical.
- ▶ Set "Transmission rate/duplex" to a fix value.
- ▶ Deactivate auto-negotiation

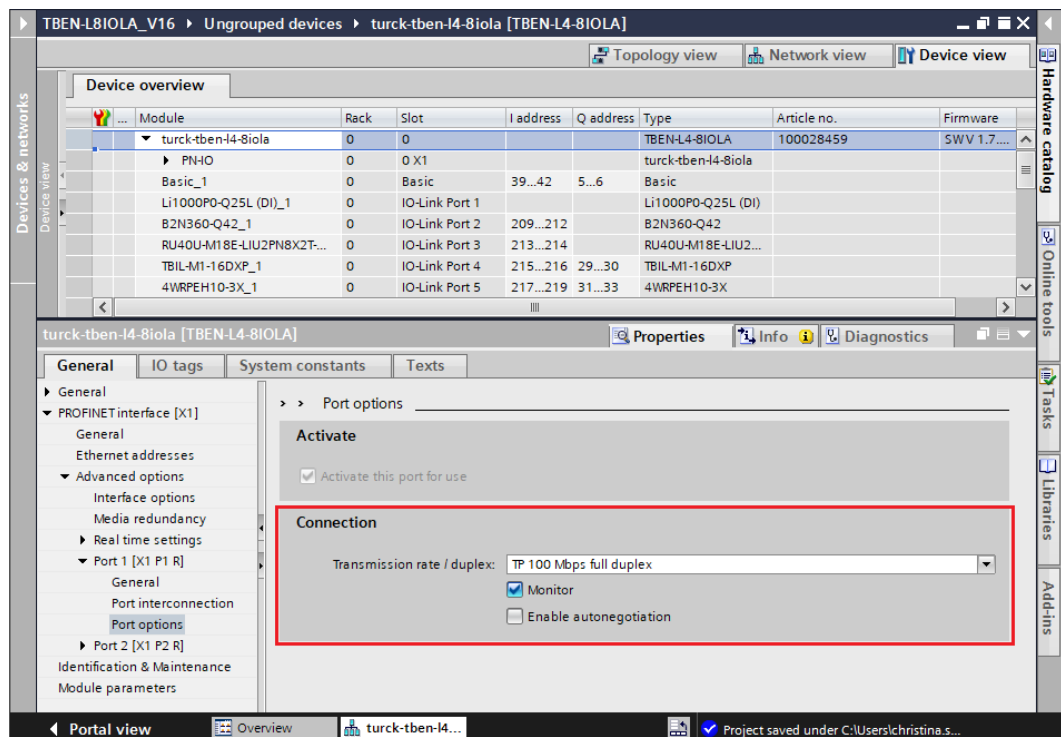

Fig. 34: TIA-Portal – port-settings for FSU

- ▶ Activate the prioritized start-up at the I/O device.

7.2.4 MRP (Media Redundancy Protocol)

The device supports MRP. MRP is a standardized protocol according to IEC 62439. It describes a mechanism for media redundancy in ring topologies. With MRP, a defective ring topology with up to 50 nodes is detected and reconfigured in the event of an error. With MRP a trouble-free switch-over is not possible.

A Media Redundancy Manager (MRM) checks the ring topology of a PROFINET network defined by the network configuration for functionality. All other network nodes are Media Redundancy Clients (MRC). In the error-free state, the MRM blocks normal network traffic on one of its ring ports, with the exception of the test telegrams. The physical ring structure thus becomes a line structure again at the logical level for normal network traffic. If a test telegram fails to appear, a network error has occurred. In this case, the MRM opens its blocked port and establishes a new functioning connection between all remaining devices in the form of a linear network topology.

The time between ring interruption and recovery of a redundant path is called reconfiguration time. For MRP, this is a maximum of 200 ms. Therefore, an application must be able to compensate for the 200 ms interruption. The reconfiguration time always depends on the Media Redundancy Manager (e.g. the PROFINET PLC) and the I/O cycle and watchdog times set here. For PROFINET, the response monitoring time must be selected accordingly > 200 ms.

It is not possible to use Fast Start-Up in an MRP network.

7.2.5 User data for acyclic services (IO-Link)

The acyclic data exchange is by using via Record Data CRs (Communication Relation). Via these Record Data CRs the reading and writing of the following services is realized:

- Writing of AR data (AR = Application Relation)
- Writing of configuration data
- Reading and writing of device data
- Reading of diagnostic data
- Reading of I/O data
- Reading of Identification Data Objects (I&M functions)

Acyclic device user data

Index		Name	Data type	Access	Comment
Dec.	Hex.				
1	0x01	Module parameters	WORD	read/write	Parameter data of the module (slot 0)
2	0x02	Module designation	STRING	read	Designation assigned to the module (slot 0)
3	0x03	Module revision	STRING	read	Firmware revision of the module
4	0x04	Vendor ID	WORD	read	Vendor ID for Turck
5	0x05	Module name	STRING	read	The device name assigned to the module
6	0x06	Module type	STRING	read	Device type of the module
7	0x07	Device ID	WORD	read	Device ID of the module
8...23	0x08... 0x17	reserved	-	-	-
24	0x18	Module diagnostics	WORD	read	Diagnostic data of the module (slot 0).
25...31	0x19... 0x1F	reserved	-	-	-
32	0x20	Input list	ARRAY of BYTE	read	List of all module input channels
33	0x21	Output list	ARRAY of BYTE	read	List of all module output channels
34	0x22	Diag. list	ARRAY of BYTE	read	List of all I/O-channel diagnostics
35	0x23	Parameter list	ARRAY of BYTE	read	List of all I/O-channel parameters
36... 28671	0x24... 0x6FFF	reserved	-	-	-
28672	0x7000	Module parameters	WORD	read/write	Activate fieldbus protocol
28673... 45039	0x7001 ... 0xAFEF	reserved	-	-	-
45040	0xAFF0	I&M0-functions		read	Identification & Maintaining
45041	0xAFF1	I&M1-functions	STRING[54]	read/write	I&M Tag function and location

Index		Name	Data type	Access	Comment
45042	0xAFF2	I&M2-functions	STRING[16]	read/ write	I&M Installation Date
45043	0xAFF3	I&M3-functions	STRING[54]	read/ write	I&M Description Text
45044	0xAFF4	I&M4-functions	STRING[54]	read/ write	I&M Signature
45045... 45055	0xAFF5 ... 0xAFFF	I&M5 to I&M15- functions		-	Not supported

Acyclic I/O channel user data

Index		Name	Data type	Access	Comment
Dec.	Hex.				
1	0x01	Module parameters	specific	read/ write	Parameters of the module
2	0x02	Module type	ENUM UINT8	read	Contains the module type
3	0x03	Module version	UINT8	read	Firmware version of I/O channels
4	0x04	Module ID	DWORD	read	Module ID of the I/O
5...9	0x05 ... 0x09	reserved	-	-	-
10	0x0A	Controller version	UINT8 array [8]	read	
11...18	0x0B... 0x12	reserved	-	-	-
19	0x13	Input data	specific	read	Input data of the respective I/O-channel
20...22	0x14 ... 0x16	reserved	-	-	-
23	0x17	Output data	specific	read/ write	Output data of the respective I/O-channel
...	...	reserved	-	-	-

Index		Name	Data type	Access	Comment
Dec.	Hex.				
247	0xF7	CAP 1	Record	read/ write	Client access point for class 1 masters
248	0xF8	CAP 2	Record	read/ write	
249	0xF9	CAP 3	Record	read/ write	
250	0xFA	CAP 4	Record	read/ write	
251	0xFB	CAP 5	Record	read/ write	
252	0xFC	CAP 6	Record	read/ write	
253	0xFD	CAP 7	Record	read/ write	
254	0xFE	CAP 8	Record	read/ write	
255	0xFF	CAP 9	Record	read/ write	Client access point for class 2 masters

7.2.6 The IO-Link function block IOL_CALL

The IO-Link function block IOL_CALL is specified in the IO-Link specification "IO-Link Integration Part 1- Technical Specification for PROFIBUS and PROFINET".

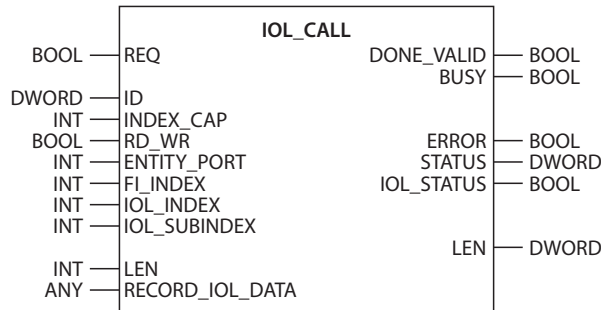

Fig. 35: IOL_CALL in accordance with IO-Link specification



NOTE

Depending on the controller manufacturer, the function blocks may deviate from the specification, e.g. in the representation and use of the variables used (example: Siemens function block IO_Link_Device for TIA Portal). For more information, refer to the documentation of the respective controller manufacturer.

Function block IOL_CALL – input variables

The following description of the function block variables is partially taken from the IO-Link specification.

Name in accordance with IO-Link specification	Data type	Meaning
REQ	BOOL	0 → 1 → 0: Send command
ID	DWORD	Address of the IO-Link master module Siemens CPU 300, 400 (PROFIBUS/PROFINET): Start address of the input data of the IO-Link master module ■ 3S CODESYS: Slot number of the IO-Link master ■ Siemens CPU 1200, 1500 (PROFIBUS/PROFINET): Hardware identifier of the IO-Link master module ■ Siemens CPU 300, 400 (PROFIBUS/PROFINET): Start address of the input data of the IO-Link master module
ITFMODULE	DWORD	Device name of the IO-Link master
INDEX_CAP	INT	Function block instance: 247...254, 255
RD_WR	BOOL	0: Write access 1: Write access
ENTITY_PORT	INT	Address of the IO-Link port to be accessed.
FI_INDEX	INT	Constant value (65098): Defines the access as IO-Link function block IOL_CALL
IOL_INDEX	INT	Number of the IO-Link index which has to be read or written
IOL_SUBINDEX	INT	Number of the IO-Link sub index which has to be read or written

Name in accordance with IO-Link specification	Data type	Meaning
LEN	INT	Length of the data to be read or written
RECORD_IOL_DATA		Source or destination for the data to be read/written

Function block IOL_CALL: output variables

The following description of the function block variables is partially taken from the IO-Link specification.

Name in accordance with IO-Link specification	Data type	Meaning
DONE_VALID	BOOL	0: Command was not executed. 1: Command was executed.
BUSY	BOOL	0: Command is currently not executed. 1: Command is currently executed.
ERROR	BOOL	0: No error present 1: Error while reading or writing.
STATUS	DWORD	Communication error status: status of the acyclic communication [▶ 45]
IOL_STATUS	DWORD	IO-Link error message: Error in the communication between IO-Link master and IO-Link device [▶ 46]
LEN	INT	Length of the read data

IOL_CALL – communication error status

The status of the acyclic communication contains 4 byte and is structured as follows:

Byte 3	Byte 2	Byte 1	Byte 0
Manufacturer specific identifier (not always applicable)	0x80 Specifies the error as an error of acyclic communication.	Error code/ status code	Vendor specific identifier (not always applicable)

Status Code	Name	Meaning
0xFF000000	TIMEOUT	Internal error in the communication with the module
0x00FFF00	INVALID_HANDLE	
0x00FFE00	HANDLE_OUT_OF_BUFFERS	
0x00FFD00	HANDLE_DESTINATION_UNAVAILABLE	
0x00FFC00	HANDLE_UNKNOWN	
0x00FFB00	HANDLE_METHOD_INVALID	
0xFF80A0XX	MASTER_READ_ERROR	Error while reading
0xFF80A1XX	MASTER_WRITE_ERROR	Error while writing
0xFF80A2XX	MASTER_MODULE_FAILURE	Failure of the IO-Link master, bus failure possible
0xFF80A6XX	MASTER_NO_DATA	No data received
0xFF80A7XX	MASTER_BUSY	IO-Link master busy

Status Code	Name	Meaning
0xXX80A9XX	MASTER_FEATURE_NOT_SUPPORTED	Function not supported by IO-Link master.
0xXX80AAXX	MASTER_RESOURCE_UNAVAILABLE	IO-Link master not available.
0xXX80B0XX	ACCESS_INVALID_INDEX	Index invalid, wrong INDEX_CAP used
0xXX80B1XX	ACCESS_WRITE_LENGTH_ERROR	Length of data to be written can not be handled from the module, wrong module accessed.
0xXX80B2XX	ACCESS_INVALID_DESTINATION	Wrong slot accessed
0xXX80B3XX	ACCESS_TYPE_CONFLICT	IOL_CALL invalid
0xXX80B5XX	ACCESS_INVALID_INDEX	Error in IOL_CALL sequence
0xXX80B6XX	ACCESS_DENIED	IO-Link master module refuses the access.
0xXX80C2XX	RESOURCE_BUSY	The IO-Link master module is busy or is waiting for an answer of the connected IO-Link device.
0xXX80C3XX	RESOURCE_UNAVAILABLE	The IO-Link master module is busy or is waiting for an answer of the connected IO-Link device.
0xXX8901XX	INPUT_LEN_TOO_SHORT	The index to be read contains more data than defined in the input variable "LEN".

IOL_CALL – IOL_STATUS

The IOL_STATUS consists of 2 byte Error Code (IOL_M Error_Codes, according to "IO-Link Integration Part 1- Technical Specification for PROFIBUS and PROFINET") and 2 byte Error Type (according to "IO-Link Interface and System").

Byte 3	Byte 2	Byte 1	Byte 0
IOL_M-Error-Code		IOL-Error Type	

IOL_M Error Code	Designation acc. to specification	Meaning
0x0000	No error	No error
0x7000	IOL_CALL Conflict	Unexpected write-request, read request expected
0x7001	Wrong IOL_CALL	Decoding error
0x7002	Port blocked	The accessed port is occupied by another task
...	reserved	
0x8000	Timeout	Timeout, IOL master or IOL device port busy
0x8001	Wrong index	Error: IOL index < 32767 or > 65535 selected
0x8002	Wrong port address	Port address not available
0x8003	Wrong port function	Port function not available
...	reserved	

IOL Error Type	Designation acc. to specification	Meaning
0x1000	COM_ERR	Communication error Possible source: the addressed port is parameterized as digital input DI and is not in IO-Link mode
0x1100	I_SERVICE_TIMEOUT	Timeout in communication, device does not respond in time

IOL Error Type	Designation acc. to specification	Meaning
0x5600	M_ISDU_CHECKSUM	Master reports checksum error, access to device not possible
0x5700	M_ISDU_ILLEGAL	Device can not respond to master request
0x8000	APP_DEV	Application error in the device
0x8011	IDX_NOTAVAIL	Index not available
0x8012	SUBIDX_NOTAVAIL	Sub-Index not available
0x8020	SERV_NOTAVAIL	The service is temporarily not available.
0x8021	SERV_NOTAVAIL_LOCTRL	Service temporarily not available, device is busy (e. g. teaching or parameterization of the device via the master active)
0x8022	SERV_NOTAVAIL_DEVCTRL	Service temporarily not available, device is busy (e. g. teaching or parameterization of the device via DTM or PLC etc. active)
0x8023	IDX_NOT_WRITEABLE	Access denied, index cannot be written
0x8030	PAR_VALOUTOFRNG	Parameter value out of the valid range
0x8031	PAR_VALGTLIM	Parameter value above upper limit
0x8032	PAR_VALLTLIM	Parameter value value below the lower limit
0x8033	VAL_LENVERRUN	Length of data to be written does not match the length defined for this parameter
0x8034	VAL_LENUNDRUN	Length of data to be written does not match the length defined for this parameter
0x8035	FUNC_NOTAVAIL	Function not available in the device
0x8036	FUNC_UNAVAILTEMP	Function not available in the device
0x8040	PARA_SETINVALID	Invalid parameter: Parameters not consistent with other parameters in the device.
0x8041	PARA_SETINCONSIST	Inconsistent parameters
0x8082	APP_DEVNOTRDY	Application not ready, device busy
0x8100	UNSPECIFIC	Vendor specific, according to device documentation
0x8101... 0x8FFF	VENDOR_SPECIFIC	

7.3 Connecting the devices to a PROFINET controller with TIA Portal

The following example describes the connection of the devices to a Siemens PLC in PROFINET by means of the programming software SIMATIC STEP7 Professional V15 (TIA-Portal).

Used hardware

The following hardware components are used in this example:

- Siemens PLC S7-1500
- IO-Link master TBEN-L...-8IOL with the following configuration:
 - Port 1: Turck temperature sensor, TS700-..., IO-Link V1.1
 - Port 2: Channel used as DI
 - Port 3: Turck linear position sensor, Li100P0-Q25LM0-..., IO-Link V1.0
 - Port 4: Channel used as DI
 - Port 5: Channel used as DI
 - Port 6: Turck IO-Link hub: TBIL-M1-16DXP, IO-Link V1.1
 - Port 7: Turck ultra sonic sensor, RU130U-M18E-..., IO-Link V1.1
 - Port 8: Turck ultra sonic sensor, B2N360-Q42-..., IO-Link V1.1

Used Software

The following software tools are used in this example:

- SIMATIC STEP7 Professional V15 (TIA-Portal)
- GSDML file for TBEN-L...-8IOL (can be downloaded for free as ZIP archive "TBEN-L_PROFINET.zip" under www.turck.com)

Prerequisites

- The software is started.
- A new project has been created.
- The controller has been added to the project.

7.3.1 Installing the GSDML-file

The GSDML file is available for free at www.turck.com.

- ▶ Adding the GSDML file: Click **Options** → **Manage general station description files (GSD)**.
- ▶ Installing the GSDML file: Define the source path for the GSDML-file and click **Install**.
- ⇒ The device is added to the hardware catalog.

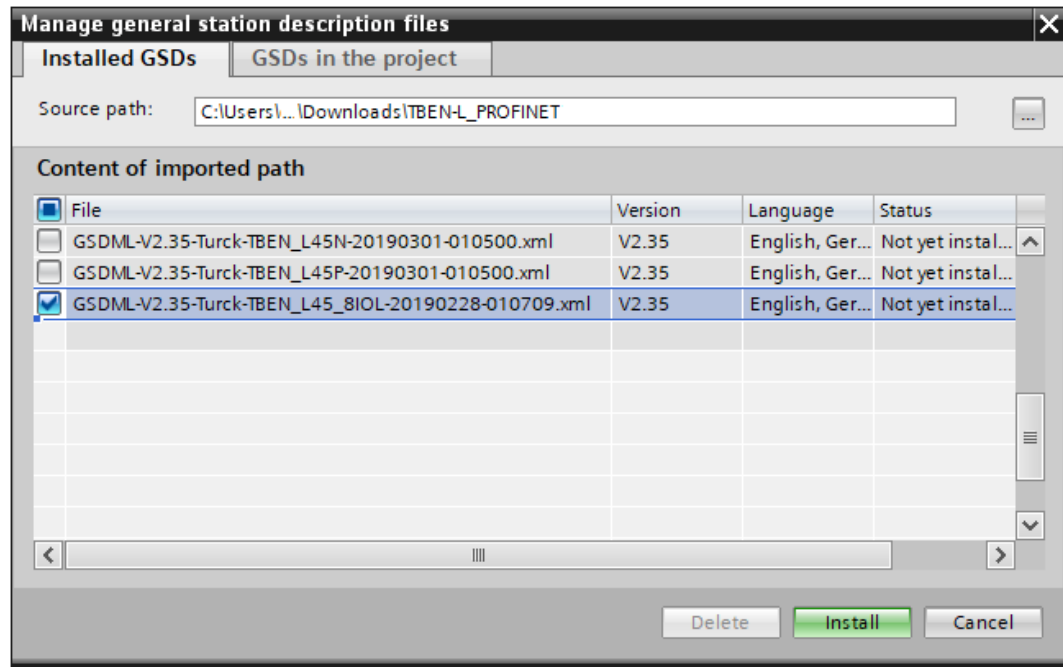

Fig. 36: TIA Portal: Installing the GSDML-file

7.3.2 Connecting the devices to the PLC

- ▶ Select the device from the Hardware catalog and drag it into the **Device & networks** editor.
- ▶ Connect the devices to the PLC in the **Devices & networks** editor.

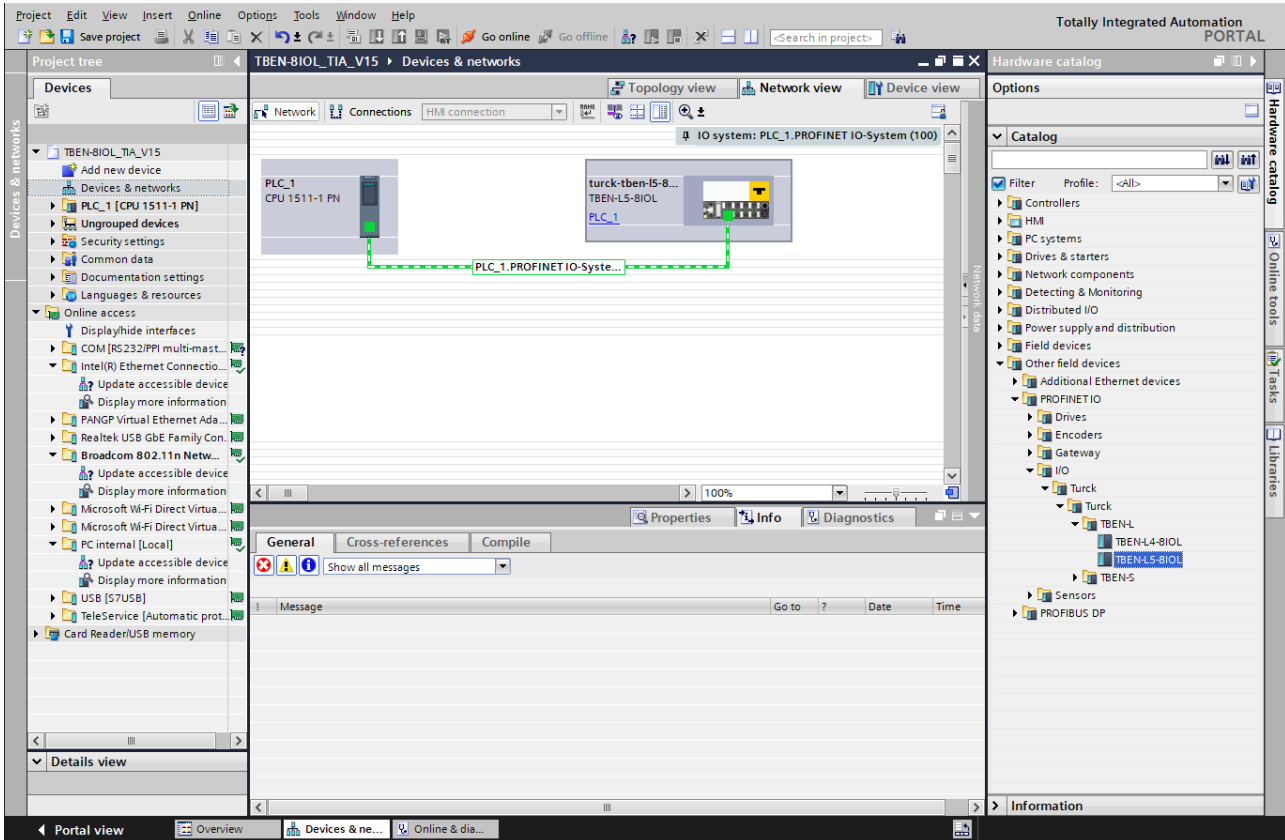

Fig. 37: Connecting the device to the PLC

7.3.3 Assigning the PROFINET device name

- ▶ Select **Online access** → **Online & diagnostics**.
- ▶ **Functions** → **Assign PROFINET device name**.
- ▶ Assign the desired PROFINET device name with **Assign name**.

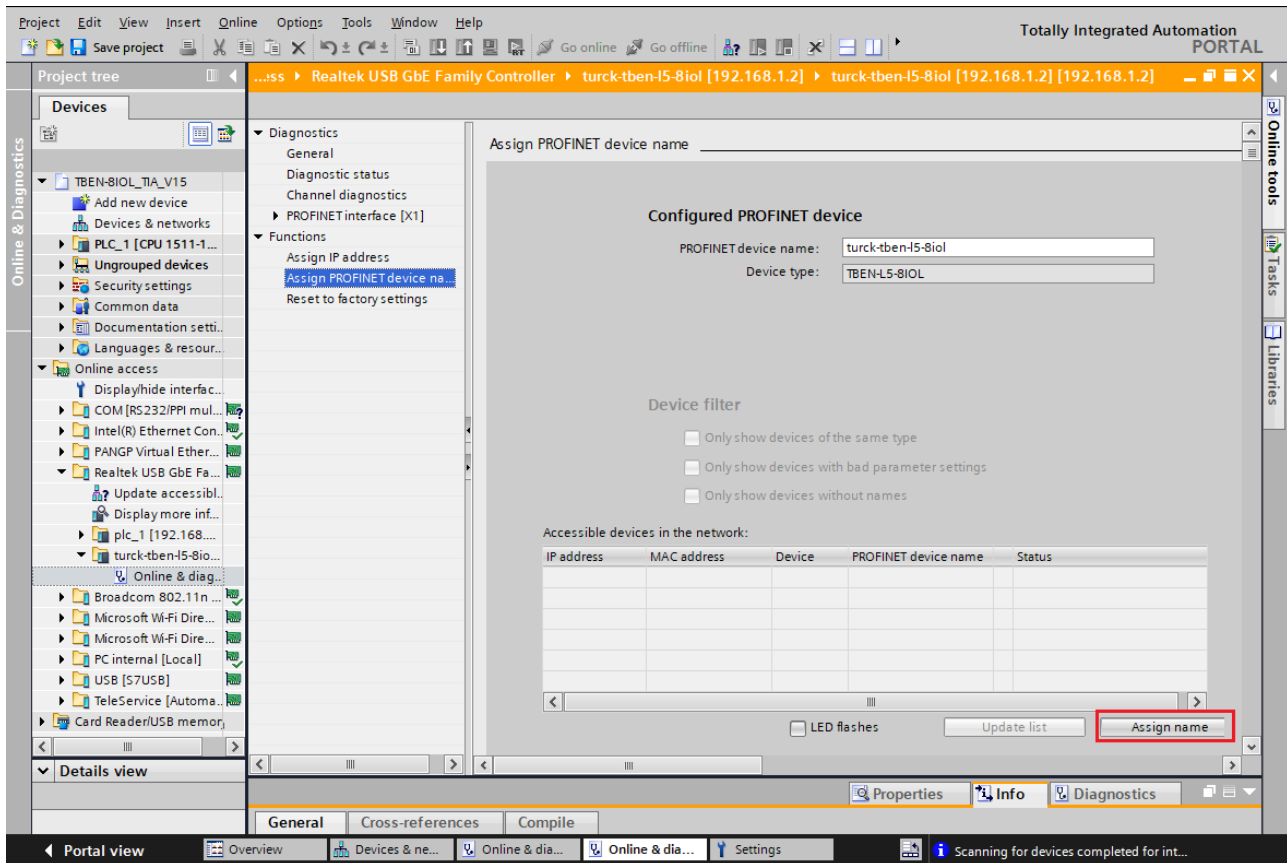

Fig. 38: TIA-Portal: Assigning the PROFINET device name

7.3.4 Setting the IP address in TIA Portal

- ▶ Select **Device view** → register **Properties** → **Ethernet addresses**.
- ▶ Assign the desired IP address.

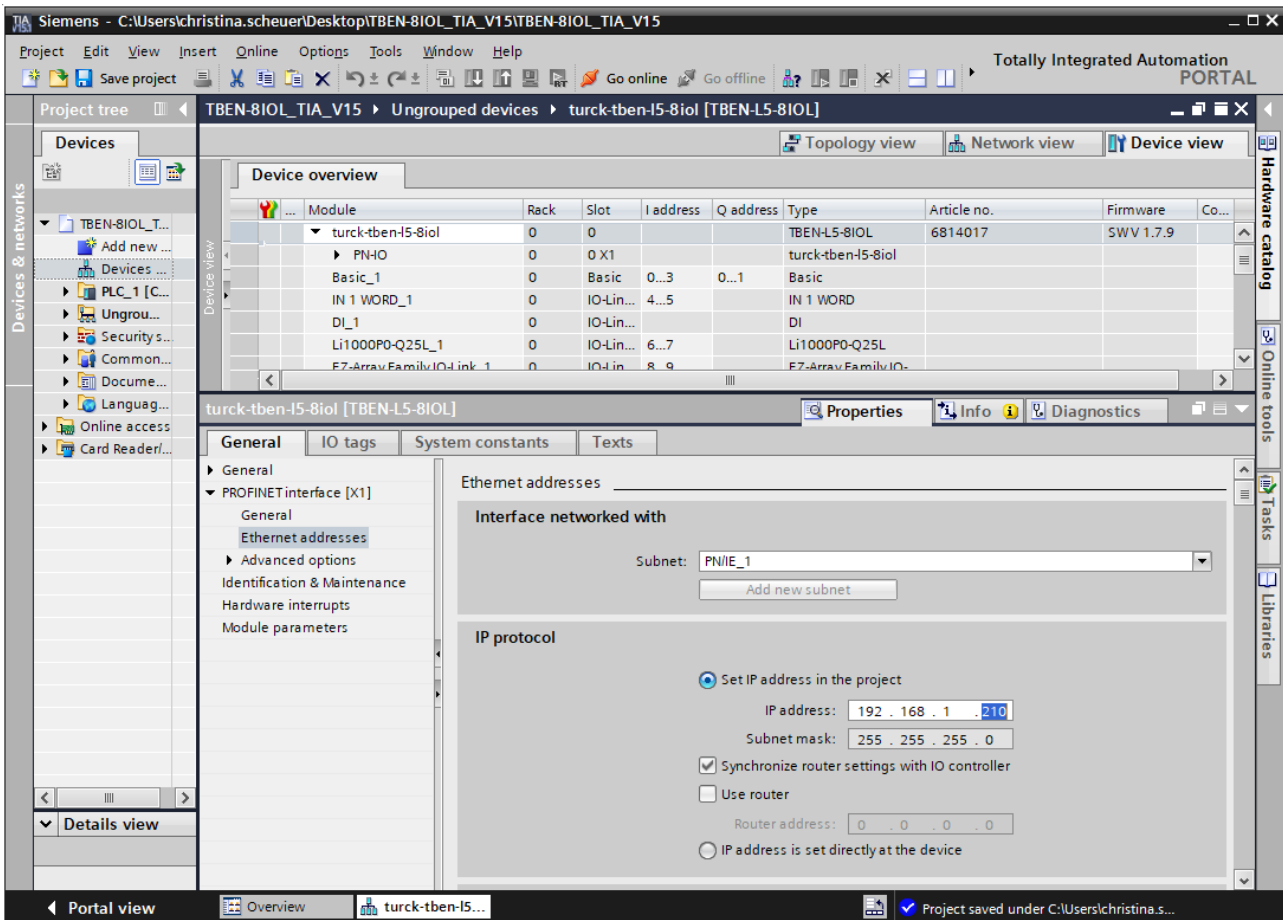

Fig. 39: TIA-Portal: Assigning the IP address

7.3.5 Configuring device functions

The TBEN-L...-8IOL appears as a modular device with twelve empty virtual slots. Slots 0 and Basic are pre-configured.

The function of the twelve empty slots is already defined in the GSDML file. The slots can only be used for a specific purpose.

Slot	Meaning
0	Main module tben-l...-8iol (Defaultname) Parameterization of functions (protocol deactivation, etc.), which are valid for the whole module.
	XI Parameterization of PROFINET functions (MRP, etc.)
	X1 P1 Parameterization of the Ethernet port properties (topology, connection options etc.).
	X1 P2
Basic	Parameters/diagnostics for the DXP-channels of the device (DXP 1, 3, 5 and 7) and Data Valid Signal from the IO-Link ports.
IO-Link port 1...8	Configuration of the eight IO-Link ports
Diagnostics	Optional mapping of the diagnostics (IO-Link and DXP-diagnostics) into the master's process image.
IO-Link Events	Optional mapping of the IO-Link events into the master's process image.
VAUX Control	Optional mapping of the VAUX diagnostics into the master's process image.
Module status	Optional mapping of the module status into the masters process image.

Configuring the IO-Link ports (example)

IO-Link port (hardware)	Process data length	IO-Link device	GSDML entry
Port 1	2 Byte IN	Turck temperature sensor, TS700-...	Port configuration generic: IN 1 WORD
Port 2	1 Bit IN	-	DI
Port 3	2 Byte IN	Turck linearity sensor, LI100P0-Q25LM0-...	Port configuration specific: LI100P0-QU25L
Port 4	2 Byte IN 2 byte OUT	Turck I/O hub, TBIL-M1-16DXP	Port configuration specific: TBIL-M1-16DXP
Port 5	1 Bit IN	-	DI
Port 6	1 Bit IN	-	DI
Port 7	1 Bit IN	Turck ultrasonic sensor, RU40U-M18E-...	Port configuration specific: RU40U-M18E-LIU2PN...(DI) The IO-Link port is configured as digital input.
Port 8	4 Byte IN	Turck inclinometer, B2N360-Q42-...	Port configuration specific: B2N360-Q42-E2LIUPN8X2

- ▶ Select Device view → Device overview.
- ▶ Select functions as operation mode, diagnostics Diagnostics etc. from the hardware catalog and add them to the device slots via drag&drop.

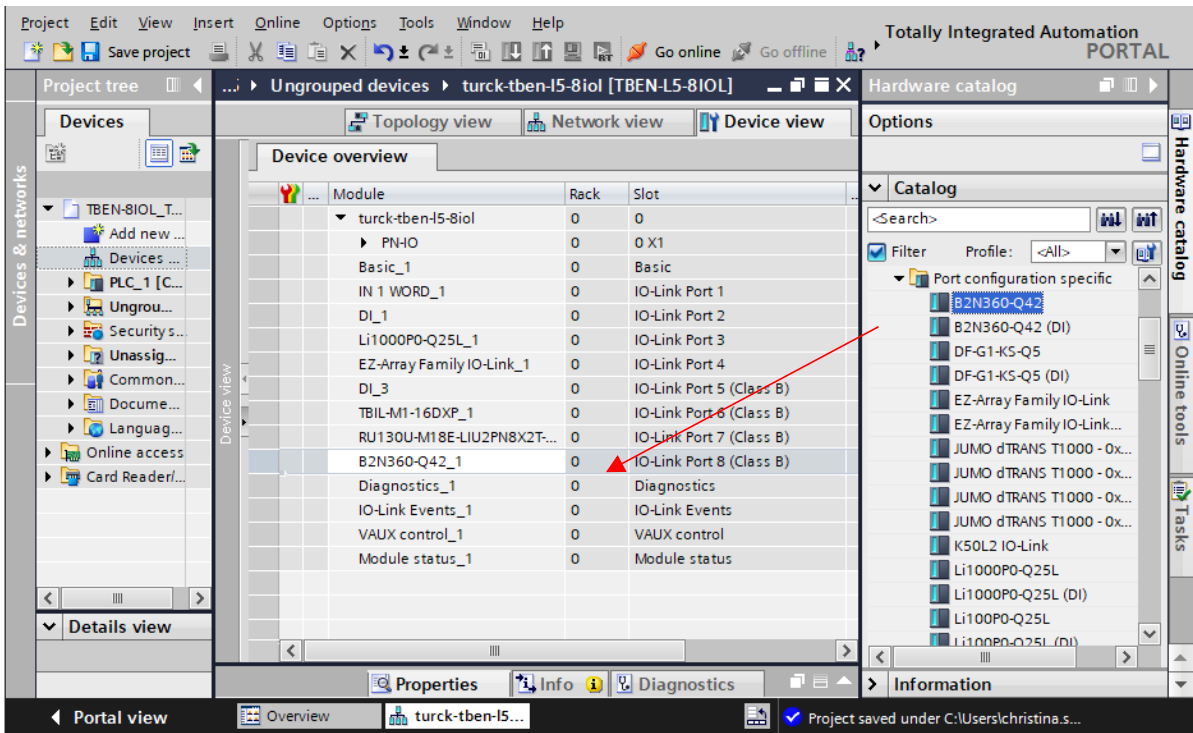

Fig. 40: TIA-Portal: Configuring device slots

Setting IO-Link port parameters

In generic port configuration, the ports of the IO-Link master can be operated in IO-Link mode with different configuration as well as in SIO mode (DI).

In specific port configuration, the IO-Link ports receive the parameters from the GSDML-file. Parameters like for example Operation mode, Data storage mode, Vendor- and Device ID cannot be changed.

- ▶ Select **Device view** → **Device overview**.
- ▶ Select the device to be parameterized.
- ▶ Click **Properties** → **General** → **Module parameters**.
- ▶ Set the device parameters.

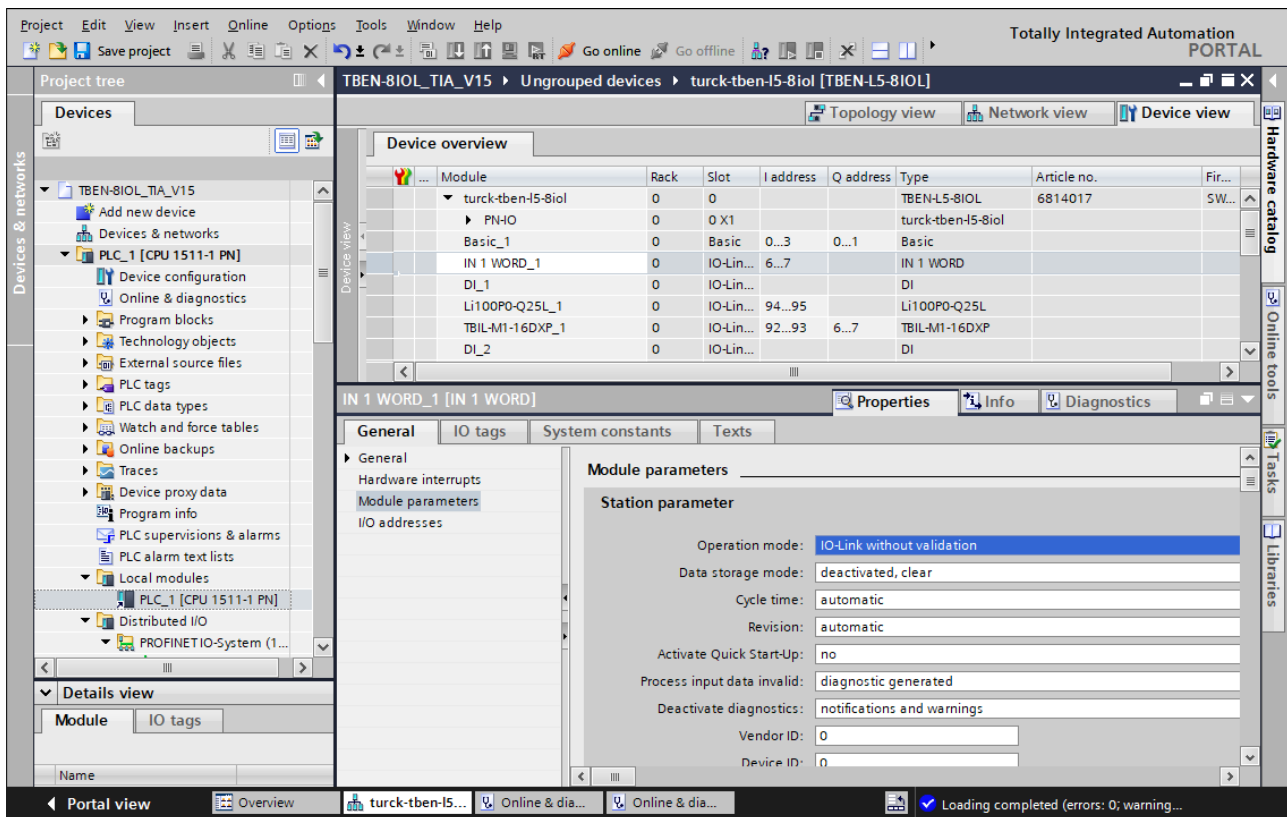

Fig. 41: TIA-Portal: parameterizing generic IO-Link devices

7.3.6 Connecting the device online with the controller

- ▶ Start the online mode (Go online).
- ⇒ The device has been successfully connected to the PLC.

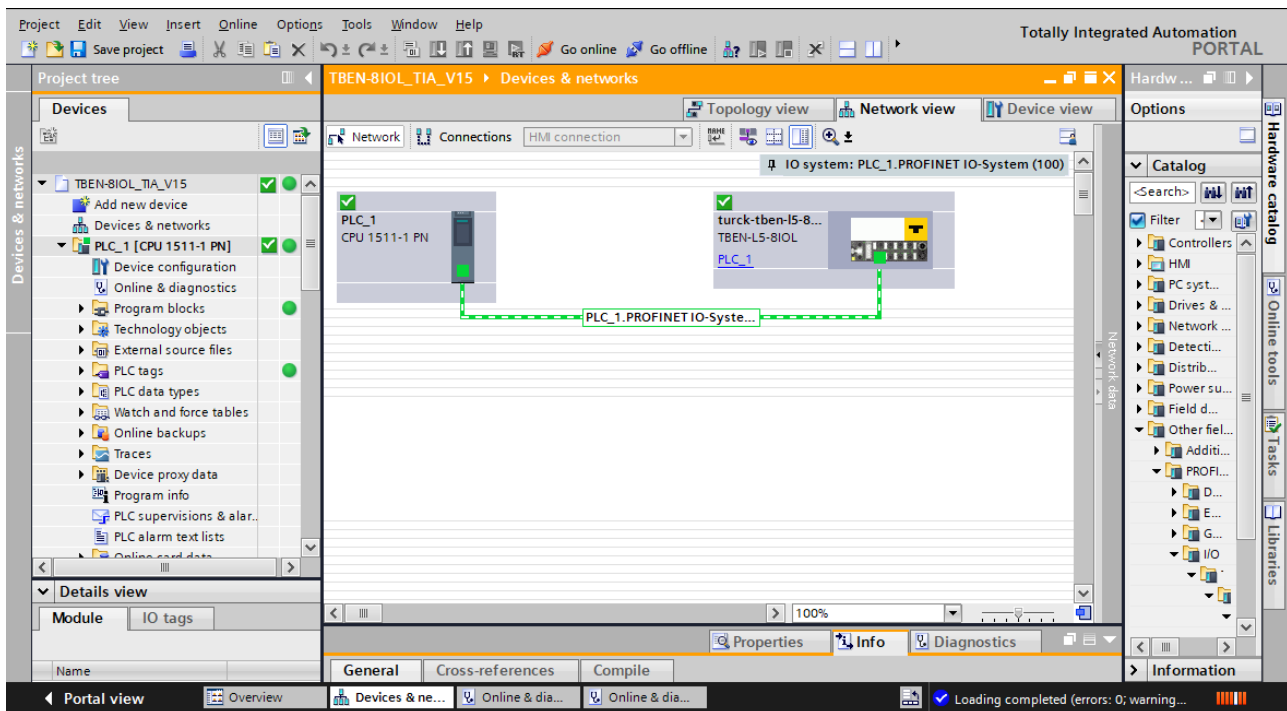

Fig. 42: TIA-Portal: Online mode

7.3.7 PROFINET – mapping

The PROFINET mapping corresponds to the data mapping described in the sections "Process Input Data" [▶ 186] and „Process Output Data" [▶ 188].

7.3.8 Using the IO_LINK_DEVICE function block in TIA Portal

The IO_LINK_DEVICE function block is based on the IOL_CALL function block according to the IO-Link specification.

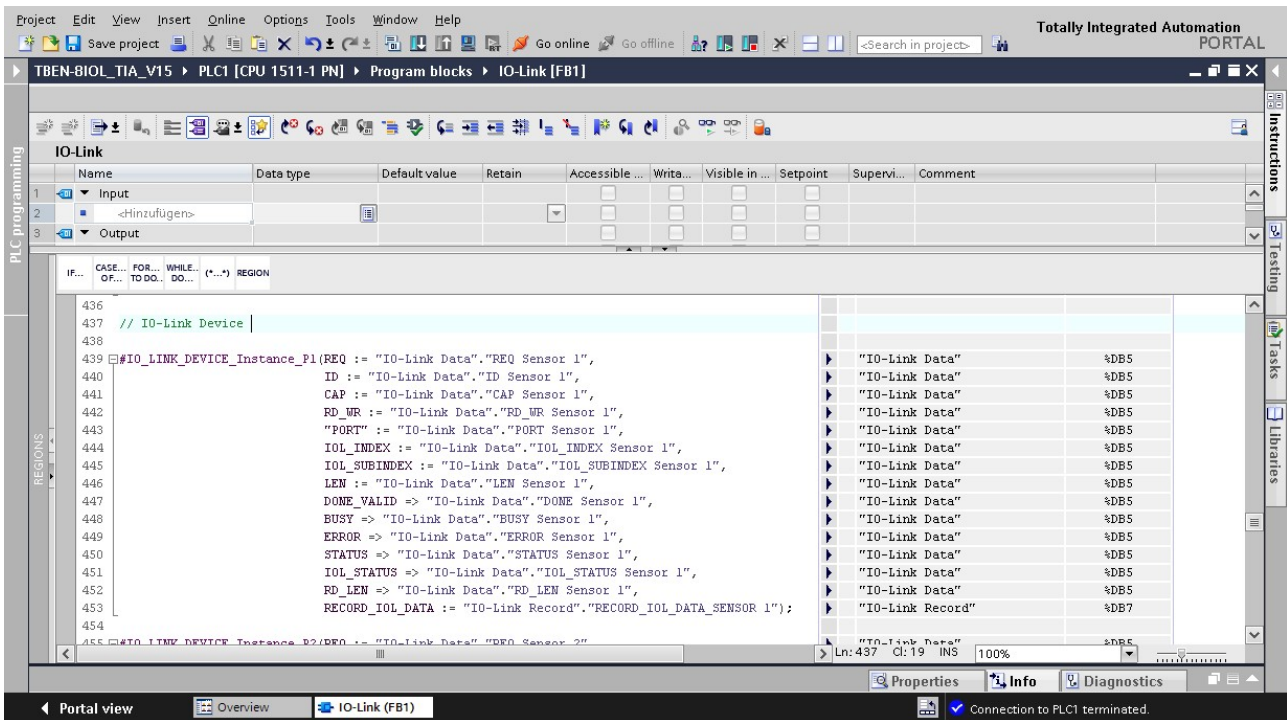

Fig. 43: Example call of Siemens FB "IO_LINK_DEVICE"



NOTE

The access to the port 0 functions of the IO-Link master with an IOL_INDEX of 65535 is not possible with version V3.0.2 of the Siemens IO_LINK_DEVICE block. In TIA Portal ≥ V15, the original IOL_CALL function block can also be used to access the Port 0 functions.

Example accesses with IO_LINK_DEVICE

In this example, the watch table **Sensor1** serves to visualize the procedure of the read and write access via IO_LINK_DEVICE. The assignment of the SPDU-indices of IO-Link devices can be found in the respective device documentation.

The function block access to the device and the connected sensors is done via the input variable **ID**. The value which has to be set as ID depends on the used CPU:

Example:

- HW identifier of the **Basic** slot (slot 1), for example with CPU 1511-PN (used in this example)
- Start address of the input data of the IO-Link master e.g. with CPU 315

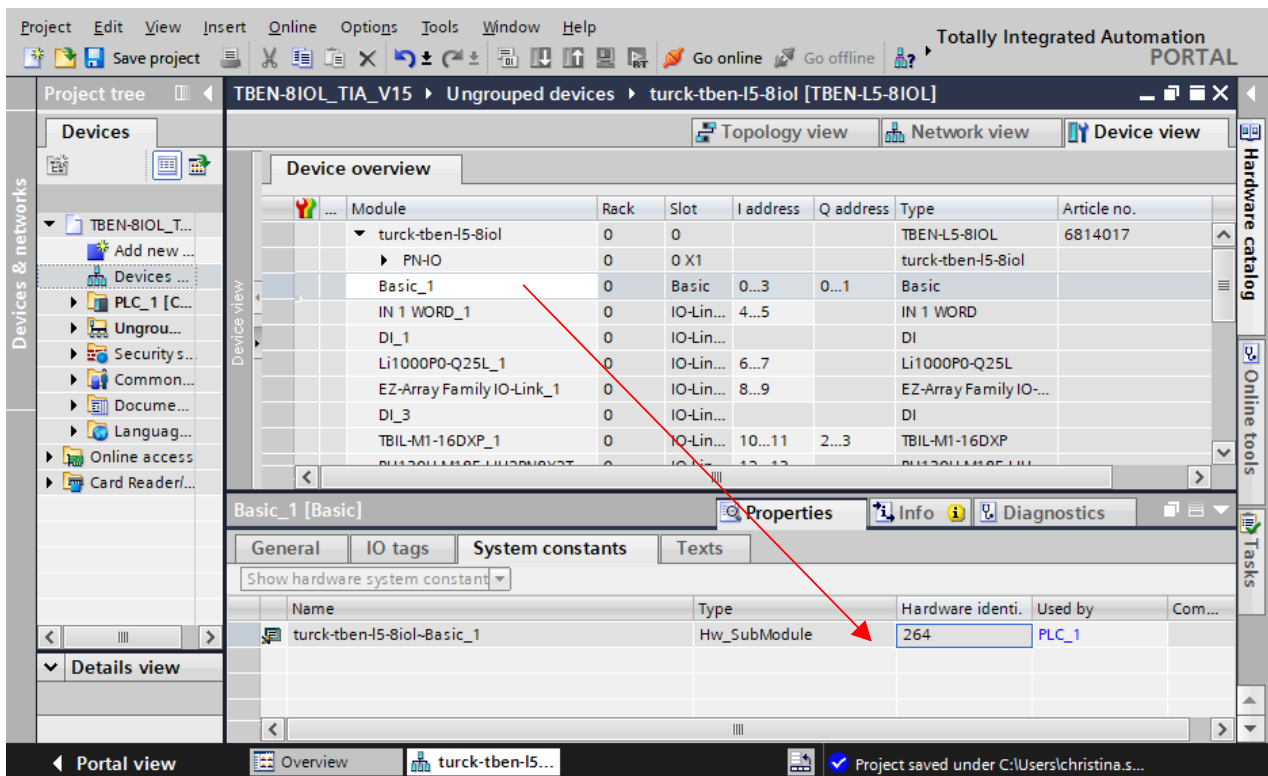

Fig. 44: Hardware identifier: Basic slot of the TBEN-L...-8IOL in the example

Example read access – read product name

Reading out the product name (product name, index 0x12) of the TURCK IO-Link I/O-hub TBIL-M1-16DXP at IO-Link port 4.

- ▶ Write the input variables of the function block via **control variable** as follows:

Variable	Value	Meaning
REQ	TRUE	Send a read request
ID	264	Hardware identifier of the Basic slot according to the configuration in the Device view
CAP	251	Function block instance
Port	4	The I/O hub TBIL-M1-16DXP is connected to port 4.
IOL_INDEX	0x12	Index for product name

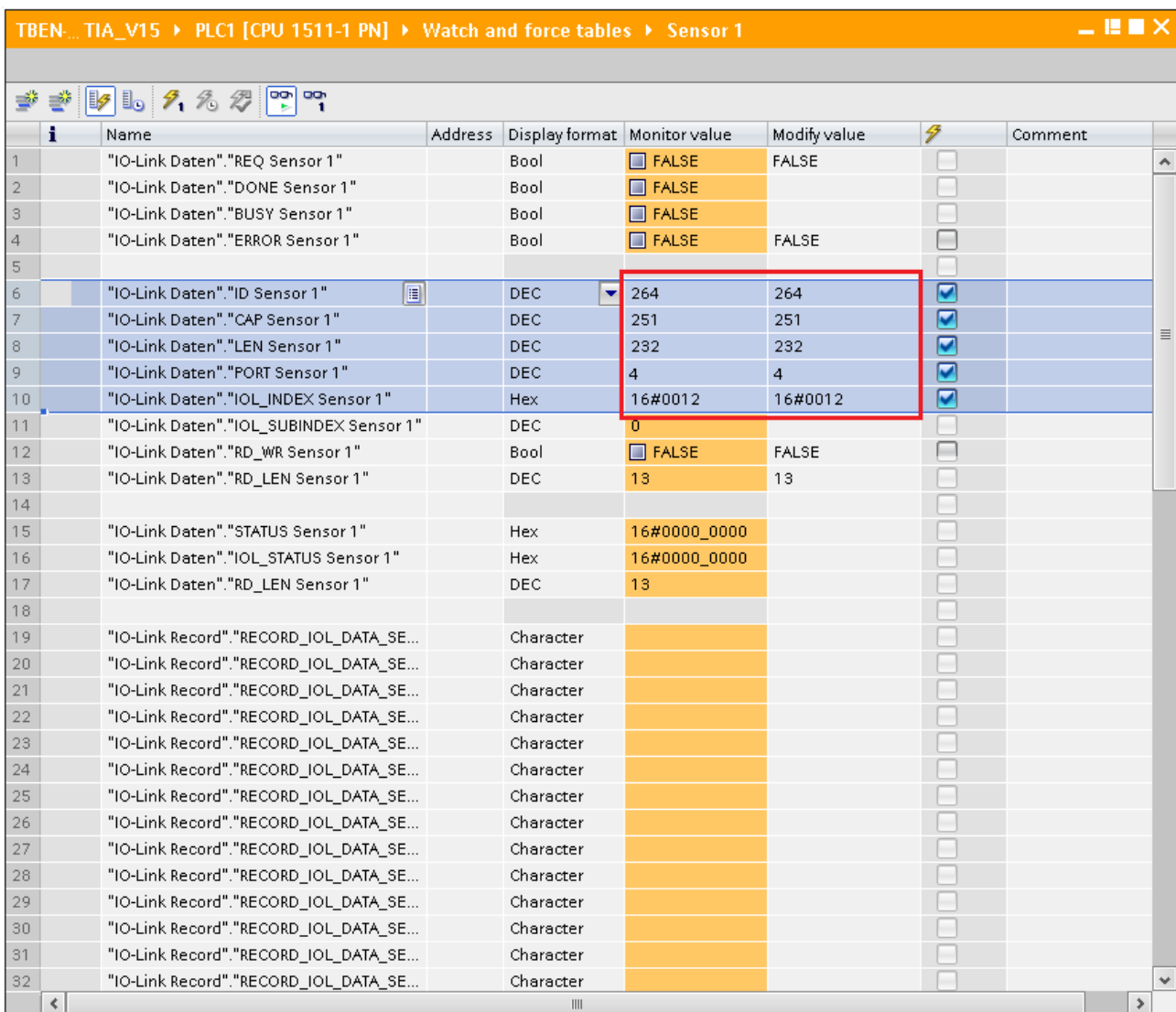

Fig. 45: IO_LINK_DEVICE – input variables for read access

- ▶ Activate the read access via a rising edge at REQ.

	i	Name	Address	Display format	Monitor value	Modify value		Comment
1		"IO-Link Daten"."REQ Sensor 1"		Bool	<input checked="" type="checkbox"/> TRUE	TRUE	<input checked="" type="checkbox"/>	0 -> 1 start CALL
2		"IO-Link Daten"."DONE Sensor 1"		Bool	<input checked="" type="checkbox"/> TRUE		<input type="checkbox"/>	
3		"IO-Link Daten"."BUSY Sensor 1"		Bool	<input type="checkbox"/> FALSE		<input type="checkbox"/>	
4		"IO-Link Daten"."ERROR Sensor 1"		Bool	<input type="checkbox"/> FALSE	FALSE	<input type="checkbox"/>	
5							<input type="checkbox"/>	
6		"IO-Link Daten"."ID Sensor 1"		DEC	264	264	<input type="checkbox"/>	
7		"IO-Link Daten"."CAP Sensor 1"		DEC	251	251	<input type="checkbox"/>	

Fig. 46: IO_LINK_DEVICE – activate read access

- ⇒ In this example, the result of this request can be seen in the watch table (row 19 and following) in the IO-Link Record.

	i	Name	Address	Display format	Monitor value	Modify value		Comment
1		"IO-Link Daten"."REQ Sensor 1"		Bool	<input checked="" type="checkbox"/> TRUE	TRUE	<input checked="" type="checkbox"/>	0 -> 1 start CALL
2		"IO-Link Daten"."DONE Sensor 1"		Bool	<input checked="" type="checkbox"/> TRUE		<input type="checkbox"/>	
3		"IO-Link Daten"."BUSY Sensor 1"		Bool	<input type="checkbox"/> FALSE		<input type="checkbox"/>	
4		"IO-Link Daten"."ERROR Sensor 1"		Bool	<input type="checkbox"/> FALSE	FALSE	<input type="checkbox"/>	
5							<input type="checkbox"/>	
6		"IO-Link Daten"."ID Sensor 1"		DEC	264	264	<input type="checkbox"/>	
7		"IO-Link Daten"."CAP Sensor 1"		DEC	251	251	<input type="checkbox"/>	
8		"IO-Link Daten"."LEN Sensor 1"		DEC	232	232	<input type="checkbox"/>	
9		"IO-Link Daten"."PORT Sensor 1"		DEC	4	4	<input type="checkbox"/>	
10		"IO-Link Daten"."IOL_INDEX Sensor 1"		Hex	16#0012	16#0012	<input type="checkbox"/>	
11		"IO-Link Daten"."IOL_SUBINDEX Sensor 1"		DEC	0		<input type="checkbox"/>	
12		"IO-Link Daten"."RD_WR Sensor 1"		Bool	<input type="checkbox"/> FALSE	FALSE	<input type="checkbox"/>	
13		"IO-Link Daten"."RD_LEN Sensor 1"		DEC	13	13	<input checked="" type="checkbox"/>	
14							<input type="checkbox"/>	
15		"IO-Link Daten"."STATUS Sensor 1"		Hex	16#0000_0000		<input type="checkbox"/>	
16		"IO-Link Daten"."IOL_STATUS Sensor 1"		Hex	16#0000_0000		<input type="checkbox"/>	
17		"IO-Link Daten"."RD_LEN Sensor 1"		DEC	13		<input type="checkbox"/>	
18							<input type="checkbox"/>	
19		"IO-Link Record"."RECORD_IOL_DATA..."		Character	'T'	'\$00'	<input type="checkbox"/>	
20		"IO-Link Record"."RECORD_IOL_DATA_SE..."		Character	'B'	'\$00'	<input type="checkbox"/>	
21		"IO-Link Record"."RECORD_IOL_DATA_SE..."		Character	'I'	'\$00'	<input type="checkbox"/>	
22		"IO-Link Record"."RECORD_IOL_DATA_SE..."		Character	'L'	'\$00'	<input type="checkbox"/>	
23		"IO-Link Record"."RECORD_IOL_DATA_SE..."		Character	'.'	'\$00'	<input type="checkbox"/>	
24		"IO-Link Record"."RECORD_IOL_DATA_SE..."		Character	'M'	'\$00'	<input type="checkbox"/>	
25		"IO-Link Record"."RECORD_IOL_DATA_SE..."		Character	'1'	'\$00'	<input type="checkbox"/>	
26		"IO-Link Record"."RECORD_IOL_DATA_SE..."		Character	'6'	'\$00'	<input type="checkbox"/>	
27		"IO-Link Record"."RECORD_IOL_DATA_SE..."		Character	'1'	'\$00'	<input type="checkbox"/>	
28		"IO-Link Record"."RECORD_IOL_DATA_SE..."		Character	'6'	'\$00'	<input type="checkbox"/>	
29		"IO-Link Record"."RECORD_IOL_DATA_SE..."		Character	'D'	'\$00'	<input type="checkbox"/>	
30		"IO-Link Record"."RECORD_IOL_DATA_SE..."		Character	'X'	'\$00'	<input type="checkbox"/>	
31		"IO-Link Record"."RECORD_IOL_DATA_SE..."		Character	'P'	'\$00'	<input type="checkbox"/>	
32		"IO-Link Record"."RECORD_IOL_DATA_SE..."		Character	16#00	'\$00'	<input type="checkbox"/>	
33		"IO-Link Record"."RECORD_IOL_DATA_SE..."		Hex	16#00		<input type="checkbox"/>	

Fig. 47: IO_LINK_DEVICE – product name TBIL-M1-16DXP

Example access write – rotate display

The display of the Turck - temperature sensor TS700 at IO-Link Port 1 is rotated. The parameter **Rotation of display** in index 91 is set to 0x01 = Rotated by 180°.

Information ✕	
Variable id	V_DISPLAY_ROT
Variable name	Rotation of Display
Index	91
Description	The display can be rotated by 180°.
Default value	Not Rotated
Data type	UIntegerT
Bit length	8 bit
Access rights	ReadWrite
Raw values	Not Rotated: 0 Rotated by 180°: 1

Fig. 48: Extract from the IODD of TS700-... in IODD viewer

- ▶ Write the input variables of the function block via **control variable** as follows.
- ▶ Activate the write access in the function block via **RD_WR Sensor 1= TRUE**.

Variable	Value	Meaning
REQ	TRUE	Send a write request
ID	264	Hardware identifier of the Basic slot according to the configuration in the Device view
CAP	251	Function block instance
LEN	1	Length of the data to be written in byte
Port	1	The temperature sensor TS700 ... is connected to port 1.
IOL_INDEX	0x5B	Index (91) for Rotation of display

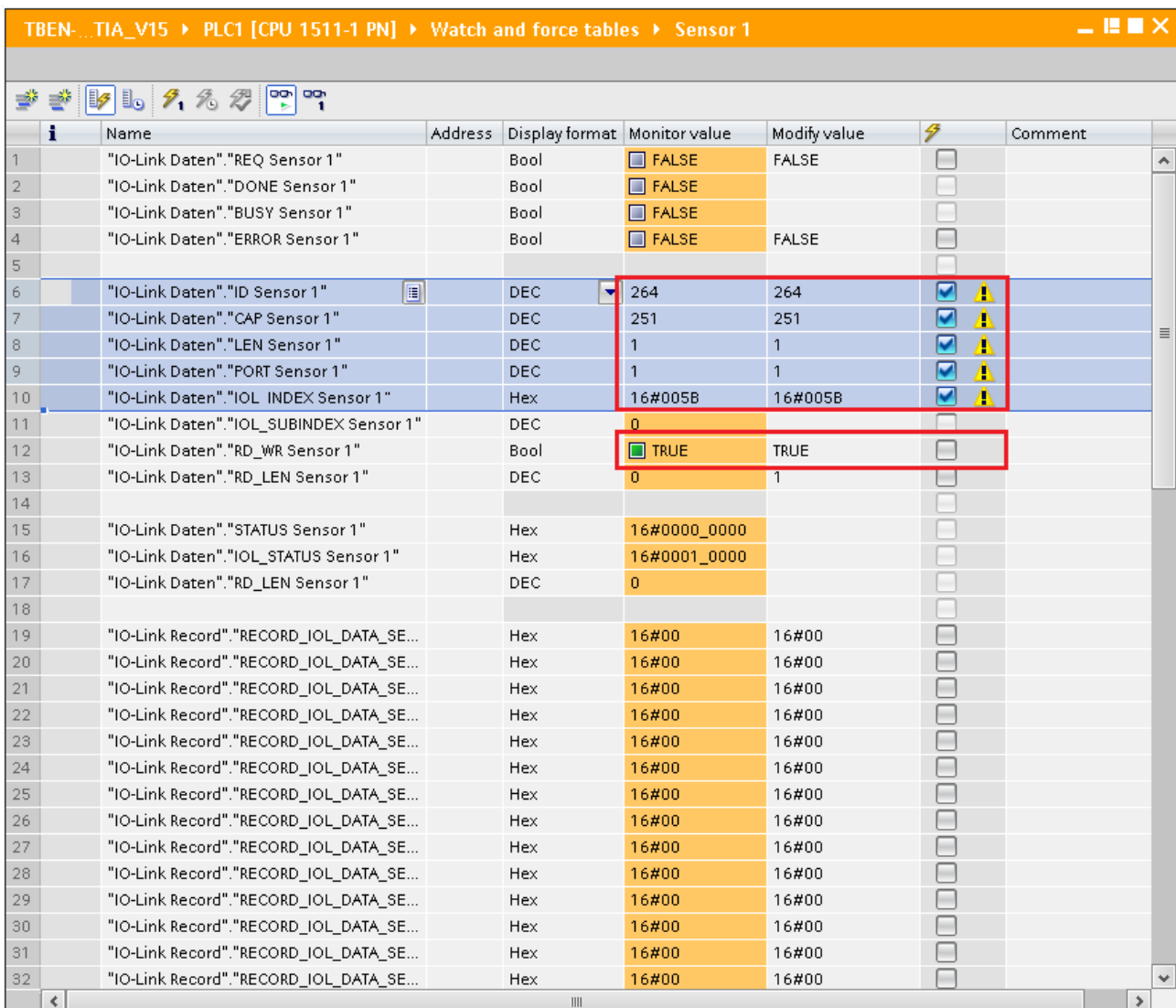

Fig. 49: IO_LINK_DEVICE – input variables for read access

- ▶ Set the value to be written **0x01** via the first word of IO-Link Record in the watch table.

	Name	Address	Display format	Monitor value	Modify value		Comment
1	"IO-Link Daten"."REQ Sensor 1"		Bool	<input type="checkbox"/> FALSE	FALSE	<input type="checkbox"/>	0 -> 1 start CALL
2	"IO-Link Daten"."DONE Sensor 1"		Bool	<input type="checkbox"/> FALSE		<input type="checkbox"/>	
3	"IO-Link Daten"."BUSY Sensor 1"		Bool	<input type="checkbox"/> FALSE		<input type="checkbox"/>	
4	"IO-Link Daten"."ERROR Sensor 1"		Bool	<input type="checkbox"/> FALSE	FALSE	<input type="checkbox"/>	
5						<input type="checkbox"/>	
6	"IO-Link Daten"."ID Sensor 1"		DEC	264	264	<input type="checkbox"/>	
7	"IO-Link Daten"."CAP Sensor 1"		DEC	251	251	<input type="checkbox"/>	
8	"IO-Link Daten"."LEN Sensor 1"		DEC	1	1	<input type="checkbox"/>	
9	"IO-Link Daten"."PORT Sensor 1"		DEC	1	1	<input type="checkbox"/>	
10	"IO-Link Daten"."IOL_INDEX Sensor 1"		Hex	16#005B	16#005B	<input type="checkbox"/>	
11	"IO-Link Daten"."IOL_SUBINDEX Sensor 1"		DEC	0		<input type="checkbox"/>	
12	"IO-Link Daten"."RD_WR Sensor 1"		Bool	<input checked="" type="checkbox"/> TRUE	TRUE	<input type="checkbox"/>	
13	"IO-Link Daten"."RD_LEN Sensor 1"		DEC	0	1	<input type="checkbox"/>	
14						<input type="checkbox"/>	
15	"IO-Link Daten"."STATUS Sensor 1"		Hex	16#0000_0000		<input type="checkbox"/>	
16	"IO-Link Daten"."IOL_STATUS Sensor 1"		Hex	16#0001_0000		<input type="checkbox"/>	
17	"IO-Link Daten"."RD_LEN Sensor 1"		DEC	0		<input type="checkbox"/>	
18						<input type="checkbox"/>	
19	"IO-Link Record"."RECORD_IOL_DATA_SE...		Hex	16#01	16#01	<input checked="" type="checkbox"/> ⚠	
20	"IO-Link Record"."RECORD_IOL_DATA_SE...		Hex	16#00	16#00	<input type="checkbox"/>	
21	"IO-Link Record"."RECORD_IOL_DATA_SE...		Hex	16#00	16#00	<input type="checkbox"/>	
22	"IO-Link Record"."RECORD_IOL_DATA_SE...		Hex	16#00	16#00	<input type="checkbox"/>	
23	"IO-Link Record"."RECORD_IOL_DATA_SE...		Hex	16#00	16#00	<input type="checkbox"/>	
24	"IO-Link Record"."RECORD_IOL_DATA_SE...		Hex	16#00	16#00	<input type="checkbox"/>	
25	"IO-Link Record"."RECORD_IOL_DATA_SE...		Hex	16#00	16#00	<input type="checkbox"/>	
26	"IO-Link Record"."RECORD_IOL_DATA_SE...		Hex	16#00	16#00	<input type="checkbox"/>	
27	"IO-Link Record"."RECORD_IOL_DATA_SE...		Hex	16#00	16#00	<input type="checkbox"/>	
28	"IO-Link Record"."RECORD_IOL_DATA_SE...		Hex	16#00	16#00	<input type="checkbox"/>	
29	"IO-Link Record"."RECORD_IOL_DATA_SE...		Hex	16#00	16#00	<input type="checkbox"/>	
30	"IO-Link Record"."RECORD_IOL_DATA_SE...		Hex	16#00	16#00	<input type="checkbox"/>	
31	"IO-Link Record"."RECORD_IOL_DATA_SE...		Hex	16#00	16#00	<input type="checkbox"/>	
32	"IO-Link Record"."RECORD_IOL_DATA_SE...		Hex	16#00	16#00	<input type="checkbox"/>	

Fig. 50: IO_LINK_DEVICE – control value 0x01 for index 0x5B

- ▶ Activate the Write access via a rising edge at REQ.

	Name	Address	Display format	Monitor value	Modify value		Comment
1	"IO-Link Daten"."REQ Sensor 1"		Bool	<input checked="" type="checkbox"/> TRUE	TRUE	<input checked="" type="checkbox"/> ⚠	0 -> 1 start CALL
2	"IO-Link Daten"."DONE Sensor 1"		Bool	<input checked="" type="checkbox"/> TRUE		<input type="checkbox"/>	
3	"IO-Link Daten"."BUSY Sensor 1"		Bool	<input type="checkbox"/> FALSE		<input type="checkbox"/>	
4	"IO-Link Daten"."ERROR Sensor 1"		Bool	<input type="checkbox"/> FALSE	FALSE	<input type="checkbox"/>	
5						<input type="checkbox"/>	
6	"IO-Link Daten"."ID Sensor 1"		DEC	264	264	<input type="checkbox"/>	
7	"IO-Link Daten"."CAP Sensor 1"		DEC	251	251	<input type="checkbox"/>	

Fig. 51: IO_LINK_DEVICE – activate read access

- ⇒ The sensor display is now 180° rotated.

7.4 Commissioning the devices in Modbus TCP

7.4.1 Implemented Modbus functions

The devices support the following functions for accessing process data, parameters, diagnostics and other services.

Function Code	
3	Read Holding Registers – reading multiple output registers
4	Read Input Registers – reading multiple input registers
6	Write Single Register – writing single output register
16	Write Multiple Registers – writing multiple output
23	Read/Write Multiple Registers – reading and writing multiple registers

7.4.2 Modbus registers

Address	Access	Meaning
0x0000...0x01FF	read only	Process data of the inputs (identical to registers 0x8000... 0x8400)
0x0800...0x09FF	read/write	Process data of the outputs (identical to registers 0x9000...0x9400)
0x1000...0x100B	read only	Module identifier, contains the first 24 characters of the device type
0x100C	read only	Module status
0x1017	read only	Register mapping revision (always 2, if not, mapping is incompatible with this description)
0x1020	read only	Watchdog, actual time in ms
0x1120	read/write	Watchdog, predefined time in ms (default: 500 ms)
0x1130	read/write	Modbus Connection Mode Register
0x1131	read/write	Modbus Connection Timeout in s. (default: 0 = never)
0x113C...0x113D	read/write	Modbus Parameter Restore (reset of parameters to default values)
0x113E...0x113F	read/write	Modbus Parameter Save (permanent storing of parameters)
0x1140	read/write	Deactivate protocol Deactivates explicitly the selected Ethernet protocol: <ul style="list-style-type: none"> ■ Bit 0 = deactivate EtherNet/IP ■ Bit 1 = deactivate Modbus TCP ■ Bit 2 = deactivate PROFINET ■ Bit 15 = deactivate web server
0x1141	read/write	Active protocol <ul style="list-style-type: none"> ■ Bit 0 = EtherNet/IP active ■ Bit 1 = Modbus TCP active ■ Bit 2 = PROFINET active ■ Bit 15 = web server active
0x1150	read only	LED behavior (PWR) at V2 undervoltage Bit 0: 0 = red 1 = green flashing
0x2400	read only	V1 in mV: 0 at undervoltage

Address	Access	Meaning
0x2401	read only	V2 in mV: 0 at undervoltage
0x8000...0x8400	read only	Process data of the inputs (identical to registers 0x0000... 0x01FF)
0x9000...0x9400	read/write	Process data of the outputs (identical to registers 0x0800...0x09FF)
0xA000...0xA400	read only	Diagnostics
0xB000...0xB400	read/write	Parameters

The following table shows the register mapping for the different Modbus addressing methods:

Description	Hex	Decimal	5 digit	Modicon
Process data of the inputs	0x0000...0x01FF	0...511	40001...40512	400001...400512
Process data of the outputs	0x0800...0x09FF	2048...2559	42049...42560	402049...402560
Module identifier	0x1000...0x1006	4096...4102	44097...44103	404097...404103
Module status	0x100C	4108	44109	404109
Watchdog, actual time	0x1020	4128	44129	404129
Watchdog, predefined time	0x1120	4384	44385	404385
Modbus connection mode register	0x1130	4400	44401	404401
Modbus connection timeout in s	0x1131	4401	44402	404402
Modbus Parameter Restore	0x113C...0x113D	4412...4413	44413...44414	404413...404414
Modbus Parameter Save	0x113E...0x113F	4414...4415	44415...44416	404415...404416
Deactivate protocol	0x1140	4416	44417	404417
Active protocol	0x1141	4417	44418	404418
LED behavior (PWR) at V2 undervoltage	0x1150	4432	44433	404433
V1 in mV	0x2400	9216	49217	409217
V2 in mV	0x2401	9217	49218	409218
Process data inputs	0x8000, 0x8001	32768, 32769	-	432769, 432770
Process data outputs	0x9000, 0x9001	36864, 36865	-	436865, 436866
Diagnostics	0xA000, 0xA001	40960, 40961	-	440961, 440962
Parameters	0xB000, 0xB001	45056, 45057	-	445057, 445058

Register 0x1130: Modbus connection mode

This register defines the behavior of the Modbus connections.

Bit	Designation	Value	Meaning
0	MB_OnlyOneWrite Permission	0	All Modbus connections receive the write authorization.
		1	Only one Modbus connection can receive the write permission. A write permission is opened until a disconnect. After the disconnect the next connection which requests a write access receives the write authorization.
1	MB_ImmediateWrite Permission	0	With the first write access, a write authorization for the respective Modbus connection is requested. If this request fails, an exception response with exception-code 0x01 is generated. If the request is accepted, the write access is executed and the write authorization remains active until the connection is closed.
		1	The write authorization for the respective Modbus connection is already opened during the connection establishment. The first Modbus connection thus receives the write authorization, all following connections do not (only if bit 0 = 1).
2...15	Reserved	-	-

Register 0x1131: Modbus connection timeout

This register defines after which time of inactivity a Modbus connection is closed through a disconnect.

Value range: 0...65535 s

default: 0 s = never (Modbus connection will never be closed)

Behavior of the BUS LED

If Modbus is the active protocol in case of a connection timeout and no further Modbus connections exist, the BUS LED behaves as follows:

Connection timeout	BUS LED
Timeout	Green flashing

Register 0x113C and 0x113D: Restore Modbus connection parameters

Registers 0x113C and 0x113D serve for resetting the parameter-register 0x1120 and 0x1130 to 0x113B to the default settings. The service resets the parameters without saving them.

Procedure:

- ▶ Write 0x6C6F to register 0x113C.
- ▶ To activate the reset of the registers, write 0x6164 ("load") within 30 seconds in register 0x113D. Both registers can also be written with one single request using the function codes FC16 and FC23.
- ⇒ The parameters are reset to default values.
- ▶ Save changes via a subsequent Save service.

Register 0x113E and 0x113F: Save Modbus connection parameters

Registers 0x113E and 0x113F are used for the non-volatile saving of parameters in registers 0x1120 and 0x1130 to 0x113B.

Procedure:

- ▶ Write 0x7361 to register 0x113E.
- ▶ Write 0x7665 ("save") within 30 seconds in register 0x113F to activate the reset of the registers. Both registers can also be written with one single request using the function codes FC16 and FC23.
- ⇒ The parameters are saved.

7.4.3 Data width

Module	Process input data	Process output data	Alignment
TBEN-L...-8IOL	344 byte	260	word by word

7.4.4 Register mapping

Register no.	Bit no.																
	15	14	13	12	11	10	9	8	7	6	5	4	3	2	1	0	
	MSB								LSB								
	Input data																
0x0000... 0x00xx	Process input data ▶ 186]																
	Module status																
0x00xx + 1 re- gister	see status- and control word ▶ 192]																
	Output data																
0x0800... 0x08xx	Process output data ▶ 188]																
	Diagnostics ▶ 192]																
0xA000	DXP channel diagnostics																
0xA001	IO-Link channel diagnosis																
...																	
0xA09																	
	Parameters																
	IO-Link Basic																
0xB000	-	-	-	-	-	-	-	-	DXP7_ SRO	-	DXP5_ SRO	-	DXP3_ SRO	-	DXP1_ SRO	-	
0xB001	-	-	-	-	-	-	-	-	DXP7_ EN DO	-	DXP5_ EN DO	-	DXP3_ EN DO	-	DXP1_ EN DO	-	
	IO-Link port 1																
0xB002	Cycle time								GSD	Activate Quick Start-Up	Data storage mode	Mode					
0xB003	-	-	-	-	-	-	-	-	Mapping PCDO		Mapping PDIN		Deactivate diag.		PDIN invalid	Rev.	
0xB004... 0xB005	-	-	-	-	-	-	-	-									
0xB006	Vendor ID																
0xB007 ... 0xB008	Device ID																
0xB009	-	-	-	-	-	-	-	-									
	IO-Link port 2																
0xB00A... 0xB011	8 registers parameter data, assignment similar to port 1																
	IO-Link port 3																
0xB012... 0xB019	8 registers parameter data, assignment similar to port 1																

Register no.	Bit no.															
	15	14	13	12	11	10	9	8	7	6	5	4	3	2	1	0
	IO-Link port 4															
0xB01A... 0xB021	8 registers parameter data, assignment similar to port 1															
	IO-Link port 5															
0xB022... 0xB029	8 registers parameter data, assignment similar to port 1															
	IO-Link port 6															
0xB02A... 0xB031	8 registers parameter data, assignment similar to port 1															
	IO-Link port 7															
0xB032... 0xB039	8 registers parameter data, assignment similar to port 1															
	IO-Link port 8															
0xB30A... 0xB041	8 registers parameter data, assignment similar to port 1															
	VAUX1 monitoring															
0xB042	-	-	-	-	-	-	VAUX1 pin1 C1 (ch2/3)	-	-	-	-	-	-	-	-	VAUX1 pin1 C0 (ch0/1)
0xB043	-	-	-	-	-	-	VAUX1 pin1 C3 (ch6/7)	-	-	-	-	-	-	-	-	VAUX1 pin1 C2 (ch4/5)
0xB044	-	-	-	-	-	-	VAUX1 pin1 C5 (ch10)	-	-	-	-	-	-	-	-	VAUX1 pin1 C4 (ch8)
0xB045	-	-	-	-	-	-	VAUX1 pin1 C7 (ch14)	-	-	-	-	-	-	-	-	VAUX1 pin1 C6 (ch12)
0xB046... 0xB047	-	-	-	-	-	-	-	-	-	-	-	-	-	-	-	-
	VAUX1 monitoring															
0xB048	-	-	-	-	-	-	VAUX2 pin2 C5 (ch11)	-	-	-	-	-	-	-	-	VAUX2 pin2 C4 (ch9)
0xB049	-	-	-	-	-	-	VAUX2 pin2 C7 (ch15)	-	-	-	-	-	-	-	-	VAUX2 pin2 C6 (ch13)

7.4.5 Error behavior (watchdog)

Behavior of outputs

In case of a failure of the Modbus communication, the outputs' behavior is as follows, depending on the defined time for the Watchdog (register 0x1120):

Watchdog	Behavior of outputs
0 ms	All outputs maintain the actual value in case of an error
> 0 ms (default = 500 ms)	Outputs switch to 0 after the watchdog time has expired (setting in register 0x1120).



NOTE

Setting the outputs to predefined substitute values is not possible in Modbus TCP. Eventually parameterized substitute values will not be used.

Behavior of the BUS LED

When the watchdog triggers, the BUS LED lights up red.

Behavior of the device in case of loss of Modbus communication

If Modbus is the active protocol and all Modbus connections are closed, the watchdog switches all outputs to "0" after the watchdog time has expired, unless another protocol (PROFINET, EtherNet/IP) has been activated in the meantime.

7.5 Connecting devices to a Modbus Client with CODESYS

Naming convention

Turck uses the terms "Modbus client" and "Modbus server" according to Modbus Organization. The following description uses the terms "Modbus TCP Master" (client) and "Modbus TCP Slave" (server) only because of the naming in CODESYS.

Used hardware

The following hardware components are used in this example:

- TX715-P3CV01 (IP address: 192.168.145.72)
- Block module TBEN-L...- (IP address: 192.168.145.200)

Used software

The following software tools are used in this example:

- CODESYS 3.5.18.2 (can be downloaded for free under www.turck.com).

7.5.1 Connecting the device to the PLC

The following components have to be added to CODESYS first, in order to connect the device to the PLC.

- Ethernet adapter
- Modbus TCP client (in CODESYS: Modbus TCP Master)
- Modbus TCP server (in CODESYS: Modbus TCP Slave)

Adding the Ethernet Adapter

- ▶ Right-click **Device** in the project tree **TX715-P3CV01**.
- ▶ Select **Add Device**.
- ▶ Select **Ethernet Adapter**.
- ▶ Click **Insert device**.
- ⇒ The Ethernet Adapter is added to the project tree as **Ethernet (Ethernet)**.

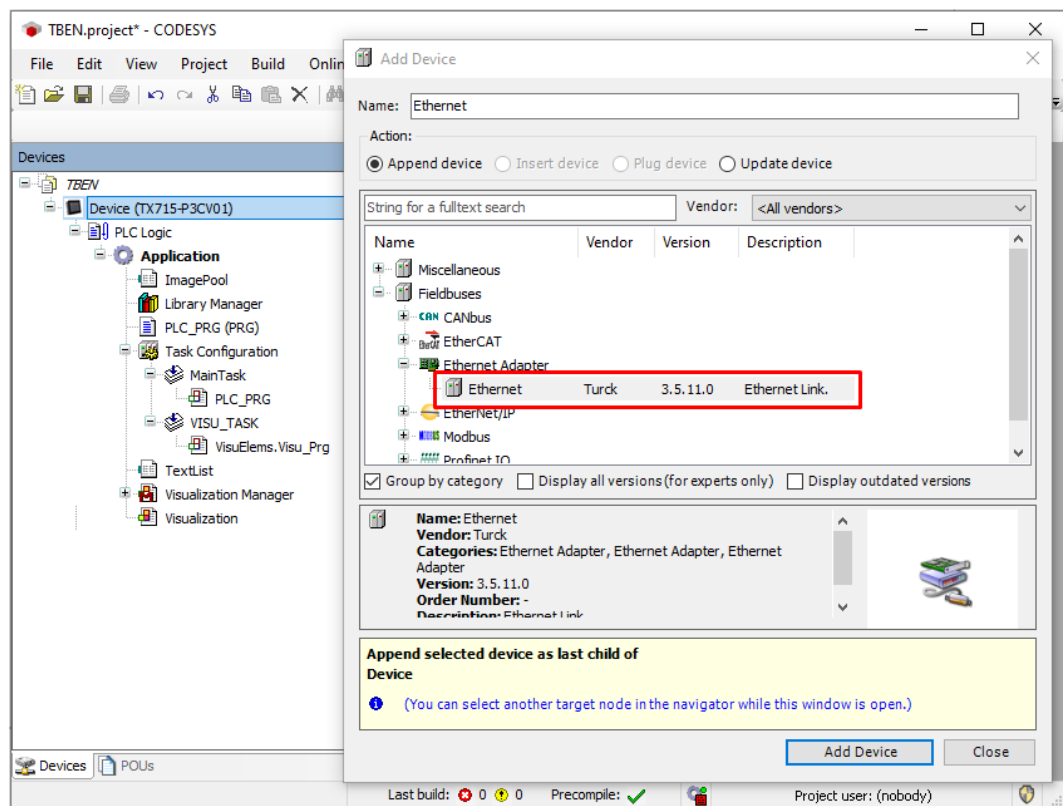

Fig. 52: Adding the Ethernet Adapter

Adding the Modbus TCP Master

- ▶ Right-click the **Ethernet (Ethernet)** in the project tree.
- ▶ Select **Add Device**.
- ▶ Double-click **Modbus TCP Master**.
- ⇒ The **Modbus_TCP_Master** is added to the project tree.

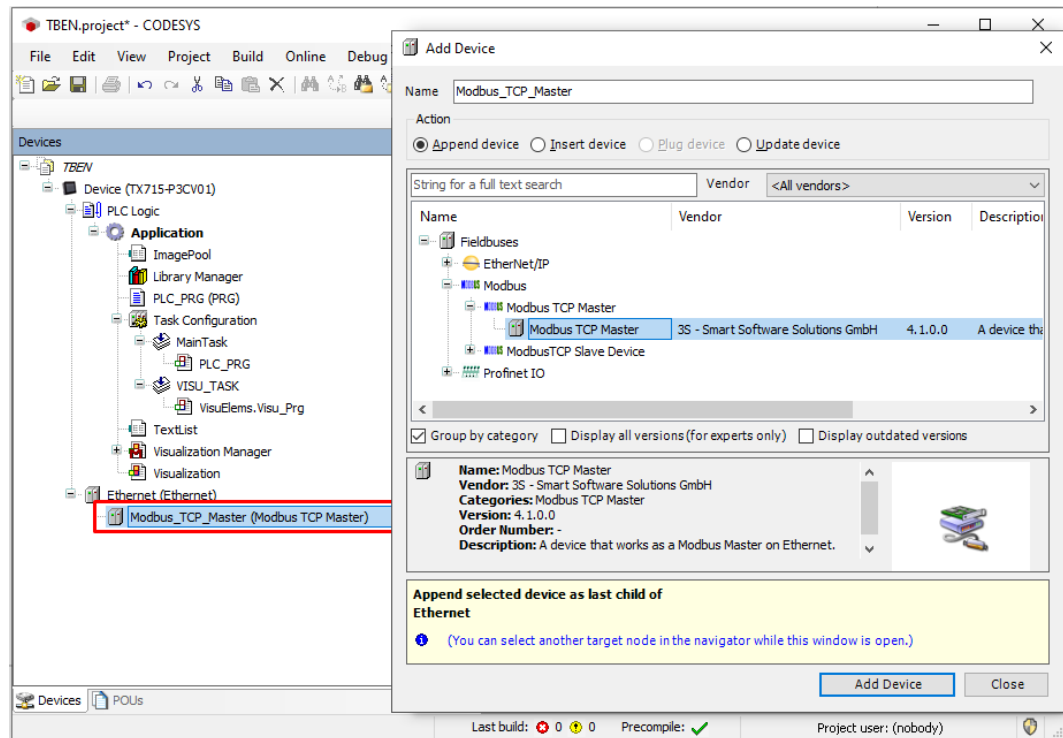

Fig. 53: Adding the Modbus TCP Master

Adding the Modbus TCP Server (Slave)

- ▶ Right-click the **Modbus TCP Master** in the project tree.
- ▶ Select **Add Device**.
- ▶ Double-click **Modbus TCP Slave**.
- ⇒ The **Modbus_TCP_Slave** is added to the project tree.

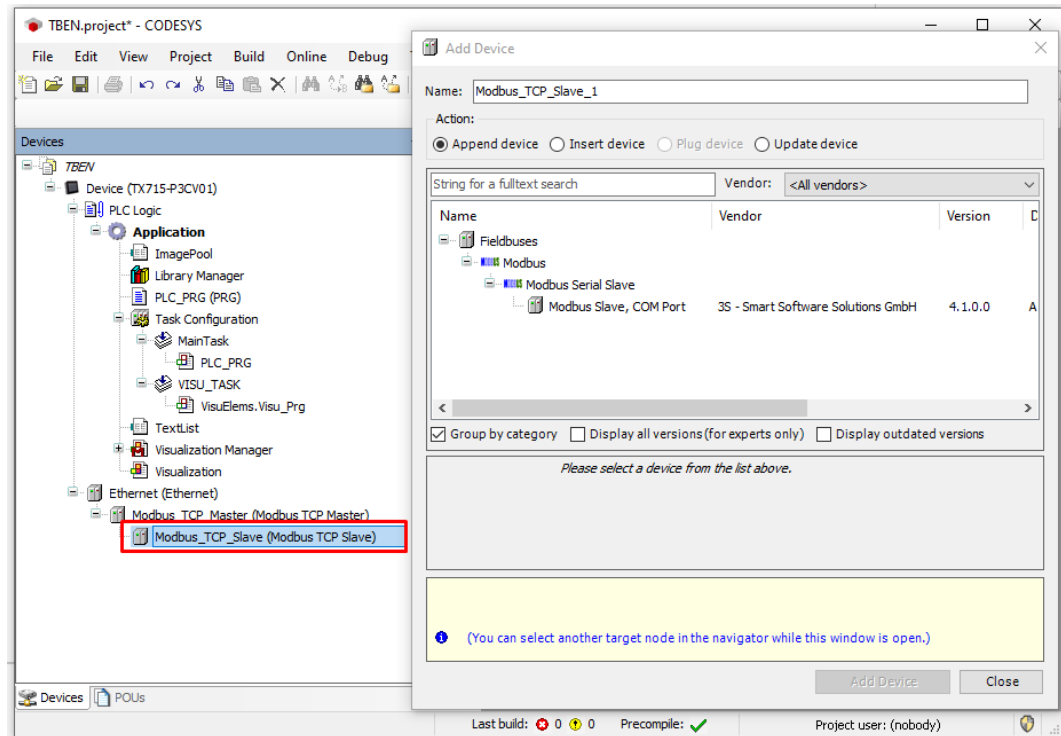

Fig. 54: Adding the Modbus TCP Slave

7.5.2 Configuring the Network Interface

- ▶ Click **Device** → **Scan network**.
- ▶ Select Modbus TCP Master (here: TX715-P3CV01) and confirm with OK.

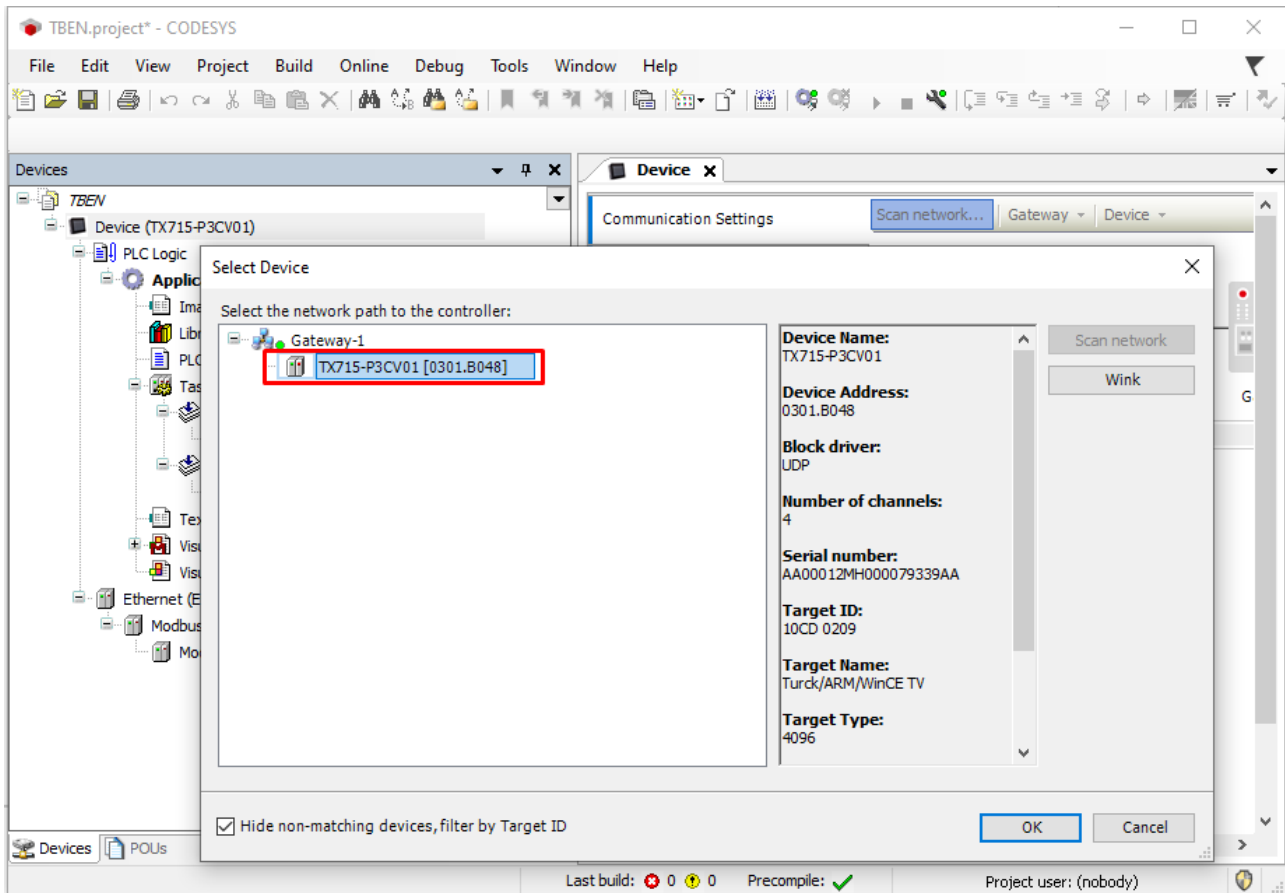

Fig. 55: Configuring the network interface

- ▶ Double-click **Ethernet**.
- ▶ Open the dialog box **Network Adapter** by clicking the **Browse...** button in the register tab **General**.
- ▶ Select the interface TX715-P3CV01 (here: 192.168.145.72)

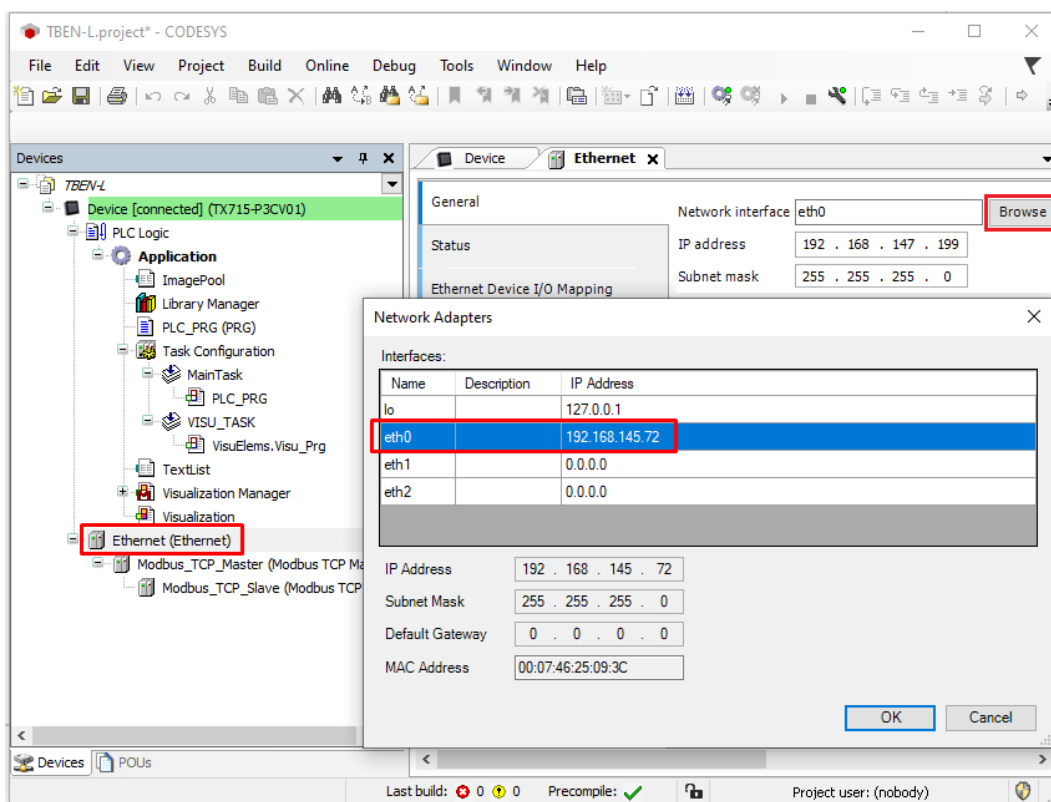

Fig. 56: Selecting the interface

7.5.3 Modbus TCP Server (Slave): setting the IP address

- ▶ Double click **Modbus TCP Server (Slave)**.
- ▶ Enter the **slave IP address** in the **General** register tab (here: 192.168.145.200).

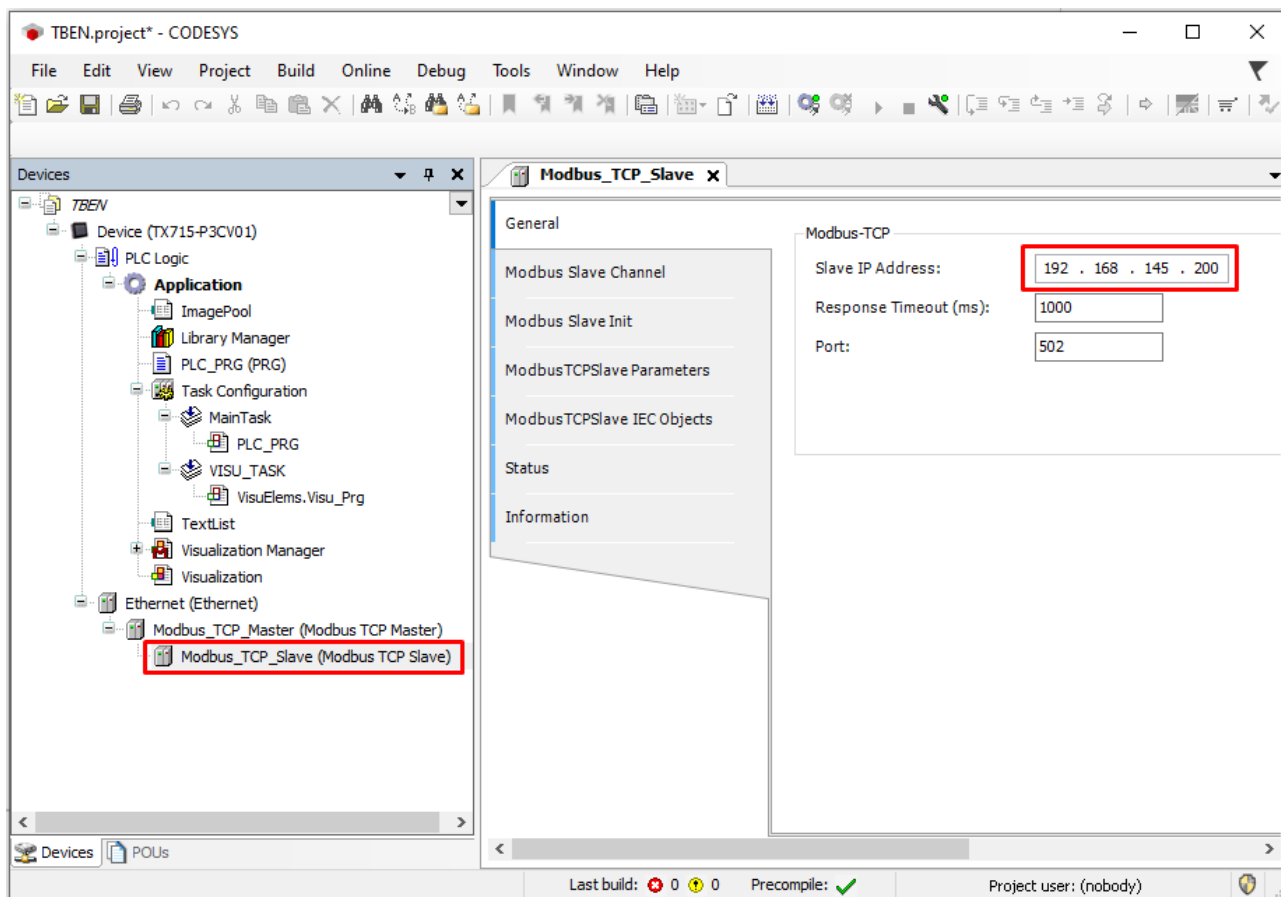

Fig. 57: Modbus TCP Slave: Setting the IP address

7.5.4 Defining modbus channels

Defining channel 0 (input data)

- ▶ Double click **Modbus TCP Slave**.
- ▶ In the register tab select **Modbus Slave Channel** → **Add Channel**.
- ▶ Enter the following values:
Channel name
Access type: Read Input Registers
Offset: 0x0000
Length: 1 register
- ▶ Confirm with OK.

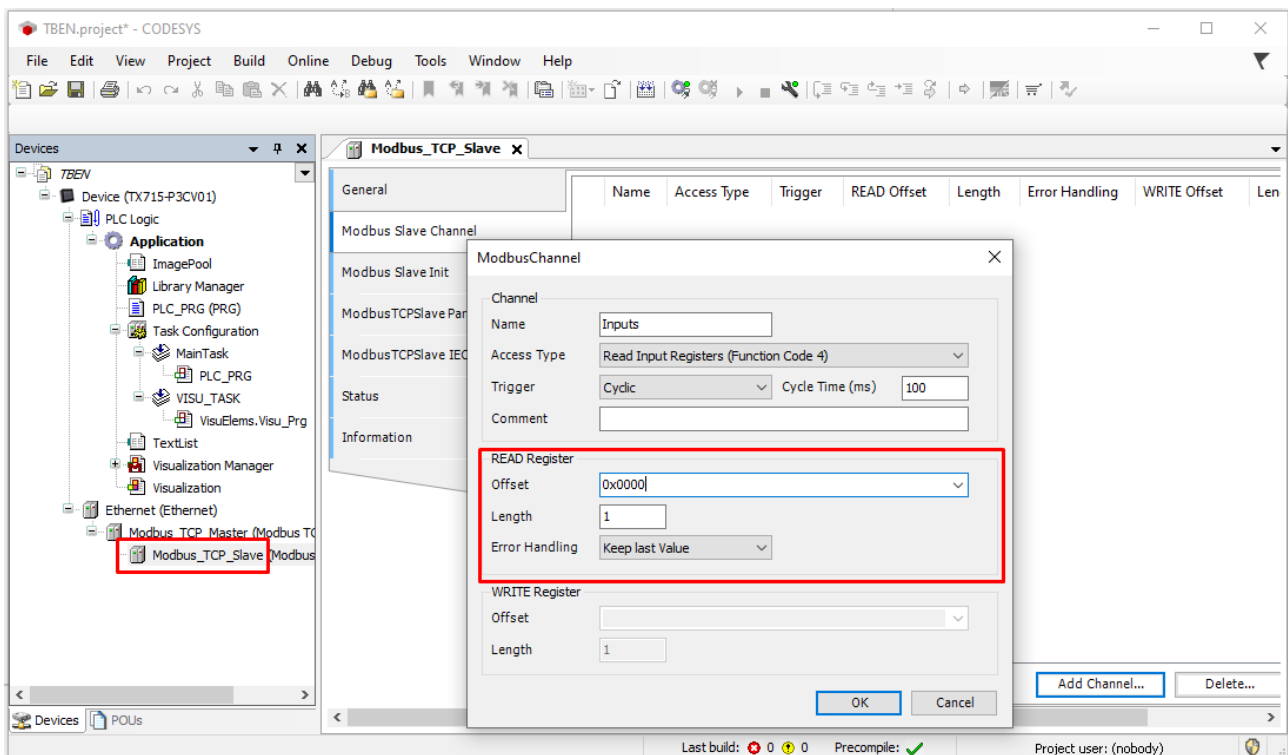

Fig. 58: Defining the input register

Defining channel 1 (output data)

- ▶ Double click **Modbus TCP Slave**.
- ▶ In the register tab select **Modbus Slave Channel** → **Add Channel**.
- ▶ Enter the following values:
Channel name
Access type Write Single Register
Offset: 0x0800
Length: 1 register
- ▶ Confirm with OK.

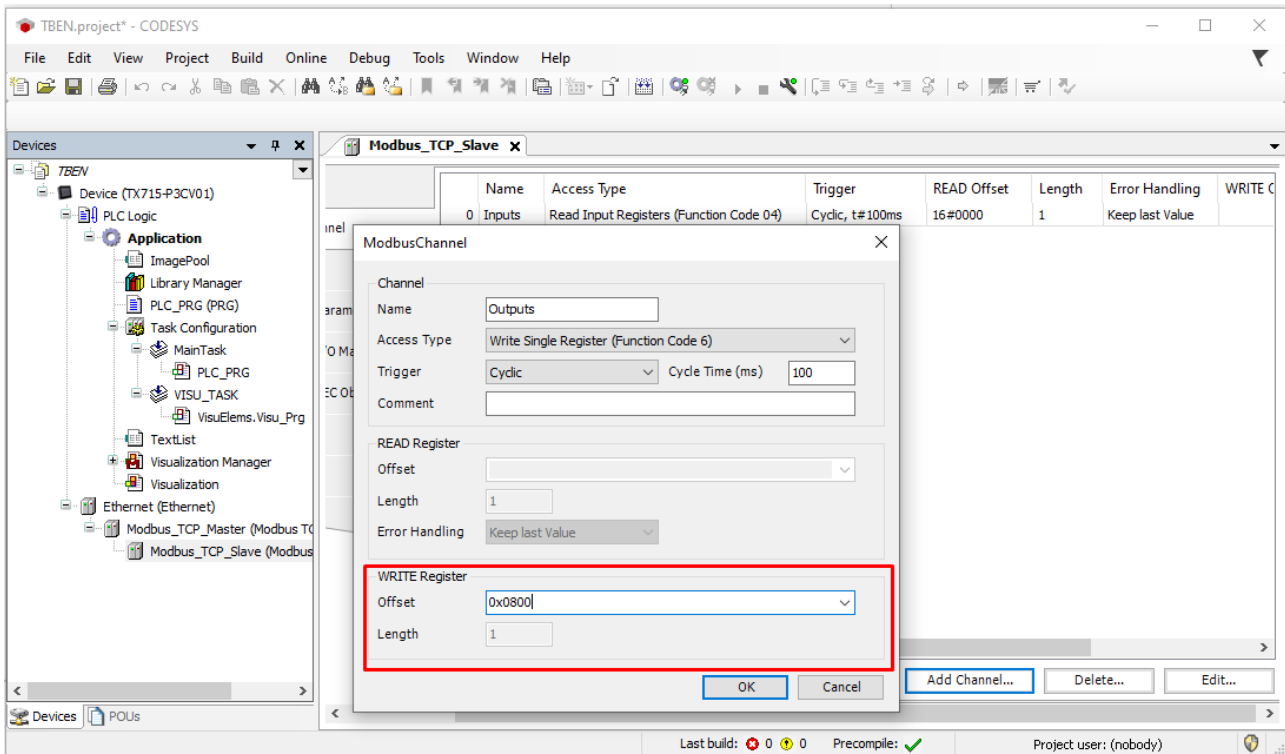

Fig. 59: Defining the output data register

7.5.5 Going online with the PLC

- ▶ Select the device.
- ▶ Click **Online** → **Login**.

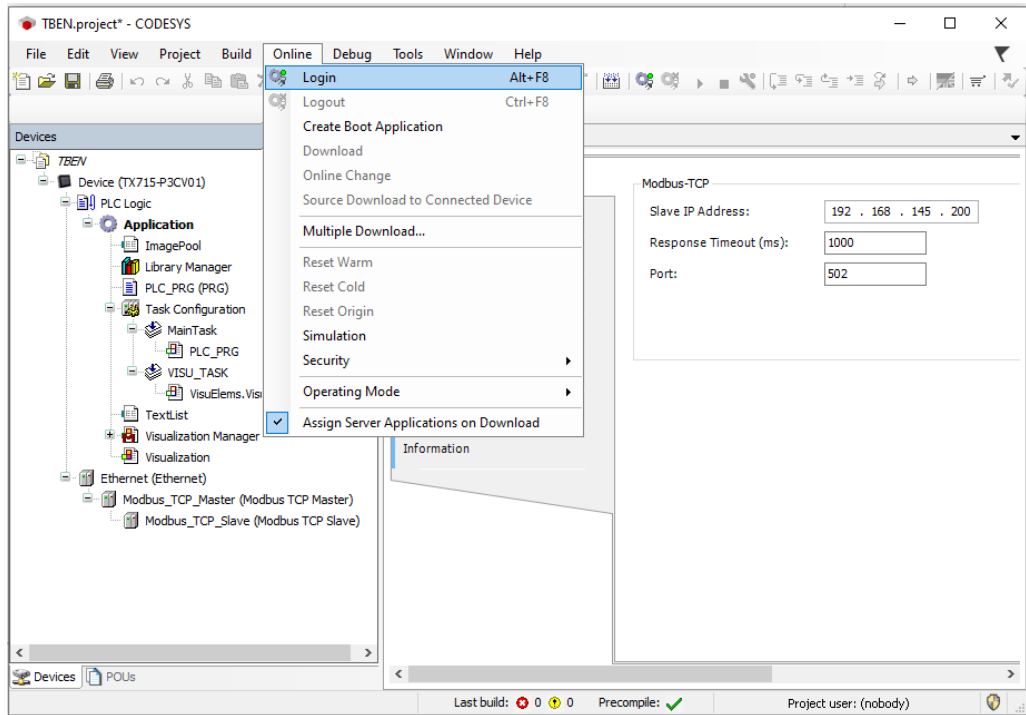

Fig. 60: Login

- ▶ Download the application to the PLC and start it via **Debug** → **Start**.
- ⇒ The Modbus TCP communication is setup.

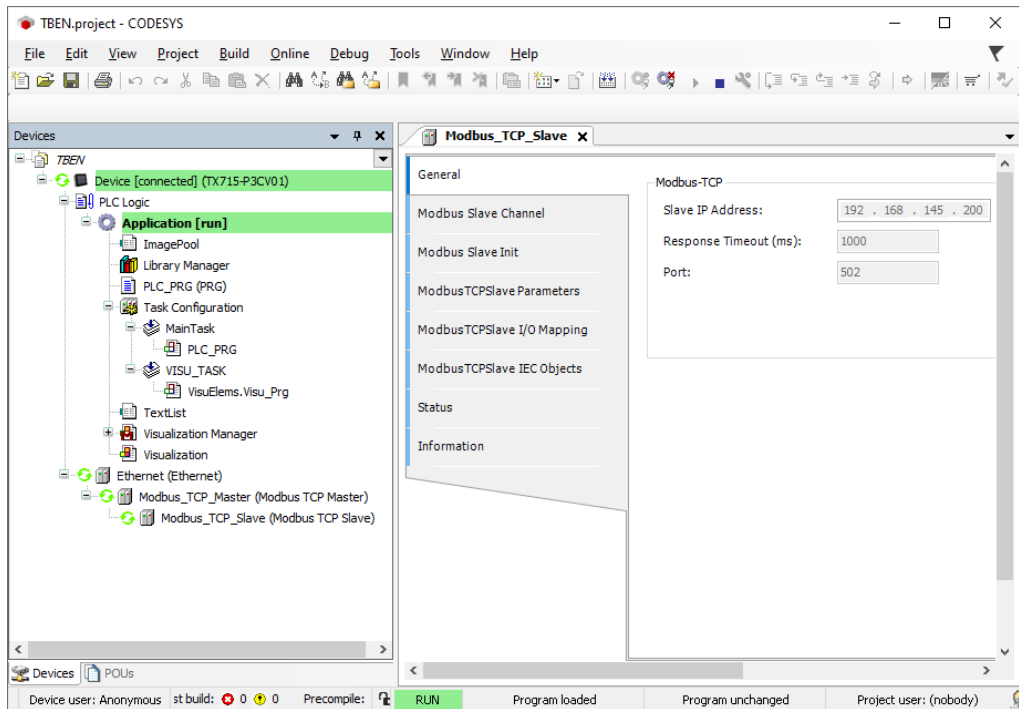

Fig. 61: Modbus TCP communication

7.5.6 Reading process data

The process data can be interpreted by means of the mapping (Register Mapping) if the device is connected to the PLC.

- ▶ Double click **Modbus TCP Slave**.
 - ▶ Click onto register tab **Modbus TCP Slave I/O Mapping**.
 - ▶ Set the function **Always update variables to Enabled 1 (...)**.
- ⇒ The process data are displayed.

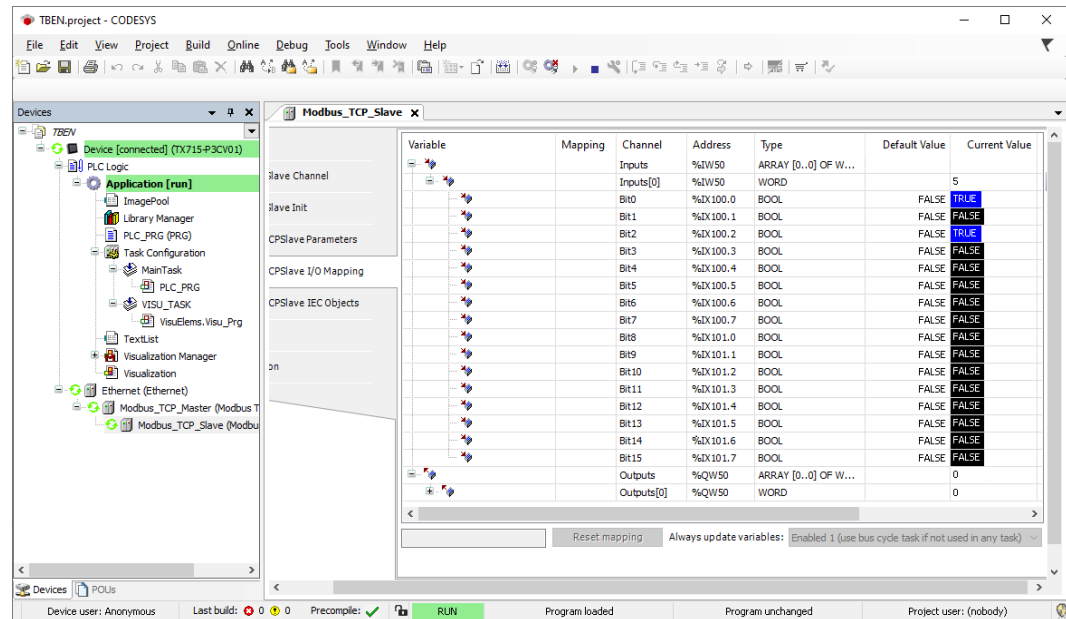

Fig. 62: Process data

7.6 Commissioning the devices in EtherNet/IP

7.6.1 Common EtherNet/IP features

Features	Description
QuickConnect	Yes (only digital channels, no IO-Link)
Device Level Ring (DLR)	Yes
Number of TCP connections	3
Number of CIP connections	10
Input assembly instance	103, 120, 121, 122, 123,124, 125
Output assembly instance	104, 150, 151, 152
Configuration assembly instance	106

7.6.2 EDS files and catalog files

The EDS and catalog files can be downloaded free of charge from www.turck.com.

- TBEN-L_ETHERNETIP.zip

7.6.3 QuickConnect (QC)

The devices support QuickConnect. The maximum start-up times defined for QuickConnect are, however, only guaranteed for the digital channels.

QuickConnect enables a PLC to build up connections to EtherNet/IP nodes in less than 500 ms after switching-on the power supply for the EtherNet/IP network. The fast start-up is necessary for fast tool changing applications at robot arms for example in the automobile industry.

QuickConnect can be activated via the web server of the device, via Configuration Assembly (e.g. in RS Logix or via Class Instance Attribute).



NOTE

Activating QuickConnect activated the automatic setting of all necessary port properties.

Port property	Status
Auto negotiation	Deactivated
Transmission speed	100BaseT
Duplex	Full duplex
Topology	Linear
AutoMDIX	Deactivated

For information on the correct connection of Ethernet cables in QuickConnect applications, please refer to the chapter Connecting [▶ 26].

Activating QuickConnect via Configuration Assembly

The Configuration Assembly is part of the device's Assembly Class.

- ▶ Configure the Configuration Assembly in RS Logix.
- ▶ Activate QuickConnect via byte9, bit 0 = 1 in the Controller Tags.

Activating Quick Connect via Class Instance Attribute

- ▶ Activate Quick Connect via Class Instance Attribute as follows:

Class	Instance	Attribute	Value
0xF5	0x01	0x0C	0: deactivated (default) 1: activated

Activating QuickConnect via the Webserver.

- ▶ Activate the checkbox **Activate QuickConnect** in the web server.

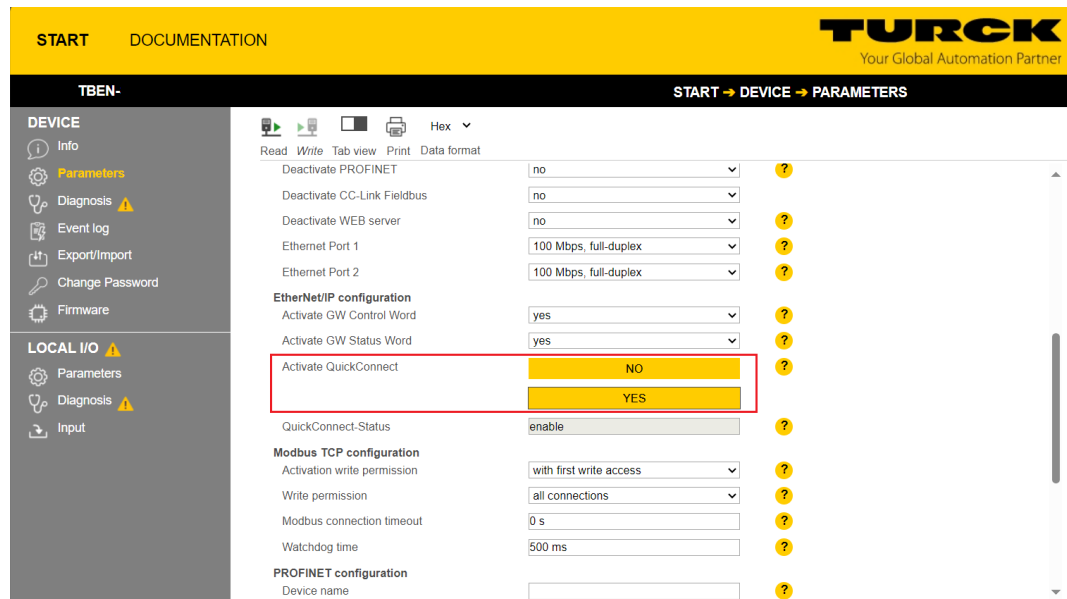

Fig. 63: Activating QuickConnect in the web server

7.6.4 Device Level Ring (DLR)

The devices support DLR (Device Level Ring). The DLR redundancy protocol is used to increase the stability of EtherNet/IP networks.

DLR-enabled devices have an integrated switch and can thus be integrated into a ring topology. The DLR protocol is used to detect an interruption in the ring. If the data line is interrupted, data are sent through an alternative network section, so that the network can be reconfigured as soon as possible.

DLR-capable network nodes (DLR supervisor) are provided with extended diagnostic functions which enable the devices to localize errors and thus decrease the time for error search and maintenance. Normally, the controller (i.e. the controller/PLC) assumes the supervisor function, all other network nodes are DLR participants. The supervisor blocks one of its two ports for normal Ethernet traffic, so that a line topology is created for normal Ethernet telegrams. DLR messages can continue to use the ring in both directions and thus continuously check the function of the ring.

7.6.5 Diagnostic messages via process data

The diagnostic messages of the IO-Link channels are directly mapped into the process data [▶ 186].

Additionally, the device's status word contains the module diagnostics:

Byte 1 (MSB)								Byte 0 (LSB)							
Bit 15	Bit 14	Bit 13	Bit 12	Bit 11	Bit 10	Bit 9	Bit 8	Bit 7	Bit 6	Bit 5	Bit 4	Bit 3	Bit 2	Bit 1	Bit 0
-	FCE	-	-	-	-	V1	-	V2	-	-	-	-	-	AR GEE	DIAG

7.6.6 EtherNet/IP standard classes

The modules support the following EtherNet/IP Standard Classes in accordance with the CIP specification.

Class Code		Object name
Dec.	Hex.	
01	0x01	Identity Object [▶ 84]
04	0x04	Assembly Object [▶ 86]
06	0x06	Connection Manager Object [▶ 99]
245	0xF5	TCP/IP Interface Object [▶ 100]
246	0xF6	Ethernet Link Object [▶ 103]

Identity Object (0x01)

The following description is taken from the CIP specification, Vol. 2, Rev. 2.1 by ODVA & Control-Net International Ltd. and adapted to the Turck products.

Instance attributes

Attr. no.		Attribute name	Get/Set	Type	Value
Dec.	Hex.				
1	0x01	Vendor	G	UINT	Contains the manufacturer ID. Turck = 0x30
2	0x02	Product type	G	UINT	Shows the general product type. Communications Adapter 12 _{dec} = 0x0C
3	0x03	Product code	G	UINT	Identifies a special product in a device type. default: 27247 _{dec} = 0x6A6F
4	0x04	Revision ■ Major ■ Minor	G	STRUCT OF: ■ USINT ■ USINT	Revision of the device which is represented by the Identity Object. ■ 0x01 ■ 0x06
5	0x05	Device status	G	WORD	WORD
6	0x06	Serial number	G	UDINT	Contains the last 3 bytes of the MAC ID
7	0x07	Product name	G	STRUCT OF: USINT STRING [13]	i.e.: TBEN-L5-8IOL

Device status

Bit	Name	Definition
0...1	Reserved	default = 0
2	Configured	TRUE = 1: The application in the device has been configured (default setting).
3	Reserved	default = 0
4...7	Extended Device Status	0011 = no I/O connection established 0110 = at least one I/O connection in RUN mode 0111 = at least one I/O connection established, all in IDLE mode All other settings = reserved
8	Minor recoverable fault	Recoverable fault, e.g.: <ul style="list-style-type: none"> ■ Undervoltage ■ Force mode of DTM active ■ Diagnostics at I/O channel active
9...10	Reserved	
11	DIAG	Common error bit
12...15	Reserved	default = 0

Common services

Service code		Class	Instance	Service name
Dec.	Hex.			
1	0x01	Yes	Yes	Get_Attribute_All Returns a predefined list of object attributes
5	0x05	No	Yes	Reset Starts the reset service for the device
14	0x0E	Yes	Yes	Get_Attribute_Single Returns the content of a specified attribute
16	0x10	No	No	Set_Attribute_Single Changes a single attribute

Assembly object (0x04)

The Assembly Object combines attributes of several objects and allows data to be sent from one object to another or to receive data in a targeted manner

The following description of the Ethernet Link Object is taken from the CIP specification, Vol. 2, Rev. 2.1 by ODVA & ControlNet International Ltd. and adapted to the Turck products.

Instance attributes

Attr. no.	Attribute name	Get/Set	Type	Value	
Dec.	Hex.				
3	0x03	Data	S	ARRAY OF BYTE	Identifies a special product in a device type. default: 27247 _{dec} = 6A6F
4	0x04	Size	G	UINT	Number of bytes in attribute 3: 256 or variable

Common services

Service code	Class	Instance	Service name	
Dec.	Hex.			
14	0x0E	Yes	Yes	Get_Attribute_Single Returns the content of a specified attribute.

Assembly instances

EtherNet/IP Connection	Input Assembly		Output Assembly		Configuration Assembly		Supported by	
	Instance	Size (in 8 bit)	Instance	Size (in 8 bit)	Instance	Size (in 8 bit)	Rockwell	Omron
Exclusive Owner	103	346	104	262	106	160	x	-
Input Only	103	346	254	0	1	0	x	-
Exclusive Owner (Omron)	103	346	104	262	1	0	-	x
Exclusive owner, IOL 4 IN/4 OUT, diagnostics	120	58	150	38	106	160	x	x
Exclusive owner, IOL 6 IN/6 OUT, diagnostics	122	74	151	54	106	160	x	x
Exclusive owner, IOL 8 IN/8 OUT, diagnostics	124	90	152	70	106	160	x	x
Exclusive owner, IOL 4 IN/4 OUT	121	38	150	38	106	160	x	x
Exclusive owner, IOL 6 IN/6 OUT	123	54	151	54	106	160	x	x
Exclusive owner, IOL 8 IN/8 OUT	125	70	152	70	106	160	x	x

Configuration Assembly (instance 106)

The modules support Configuration Assembly.

The Configuration Assembly contains:

10 byte device configuration data (EtherNet/IP specific)

+ 136 Byte (parameter data, depending on device type)

The meaning of the input data can be found in chapter "Parameterizing and configuring".

Byte no.		Bit no.							
Dec.	Hex.	7	6	5	4	3	2	1	0
Device Configuration Data									
0...8	0x00... 0x08	-	-	-	-	-	-	-	-
9	0x09	-	-	-	-	LED behavior (PWR) at V2 undervoltage	Eth2 port setup	Eth1 port setup	QuickConnect (not supported)
DXP channels									
10	0x0A	-	-	-	-	-	-	-	DXP1_SRO
11	0x0B	-	-	-	-	-	-	-	DXP3_SRO
12	0x0C	-	-	-	-	-	-	-	DXP5_SRO
13	0x0D	-	-	-	-	-	-	-	DXP7_SRO
14	0x0E	-	-	-	-	-	-	-	DXP1_EN DO
15	0x0F	-	-	-	-	-	-	-	DXP3_EN DO
16	0x10	-	-	-	-	-	-	-	DXP5_EN DO
17	0x11	-	-	-	-	-	-	-	DXP7_EN DO
IO-Link port parameters									
		IO-Link port 1							
18	0x12	-	-	-	-	Operation mode			
19	0x13	-	-	-	-	-	-	Data Storage Mode	
20	0x14	Cycle time							
21	0x15	-	-	-	-	-	-	-	Revision
22	0x16	-	-	-	-	-	-	-	Quick Start-Up
23	0x17	-	-	-	-	-	-	-	GSD
24	0x18	-	-	-	-	-	-	-	PCDI invalid
25	0x19	-	-	-	-	-	-	-	Deactivate diagnostics
26	0x1A	-	-	-	-	-	-	Mapping PDIN	
27	0x1B	-	-	-	-	-	-	Mapping PDOOUT	
28...29	0x1C... 0x1D	Vendor ID							
30...33	0x1E... 0x21	Device ID							
34...49	0x22... 0x31	IO-Link port 2							
50...65	0x32... 0x41	IO-Link port 3							

Byte no.		Bit no.							
Dec.	Hex.	7	6	5	4	3	2	1	0
66...81	0x42... 0x51	IO-Link port 4							
82...97	0x52... 0x61	IO-Link port 5							
98...113	0x62... 0x71	IO-Link port 6							
114...129	0x72... 0x81	IO-Link port 7							
130...145	0x82... 0x91	IO-Link port 8							
146	0x92	-	-	-	-	-	-	-	VAUX1 pin1 C0 (ch0/1)
147	0x93	-	-	-	-	-	-	-	VAUX1 pin1 C1 (ch2/3)
148	0x94	-	-	-	-	-	-	-	VAUX1 pin1 C2 (ch4/5)
149	0x95	-	-	-	-	-	-	-	VAUX1 pin1 C3 (ch6/7)
150	0x96	-	-	-	-	-	-	-	VAUX1 pin1 C4 (ch8)
151	0x97	-	-	-	-	-	-	-	VAUX2 pin2 C4 (ch9)
152	0x98	-	-	-	-	-	-	-	VAUX1 pin1 C5 (ch10)
153	0x99	-	-	-	-	-	-	-	VAUX2 pin2 C5 (ch11)
154	0x9A	-	-	-	-	-	-	-	VAUX1 pin1 C6 (ch12)
155	0x9B	-	-	-	-	-	-	-	VAUX2 pin2 C6 (ch13)
156	0x9C	-	-	-	-	-	-	-	VAUX1 pin1 C7 (ch14)
157	0x9D	-	-	-	-	-	-	-	VAUX2 pin2 C7 (ch15)

Device configuration data

Parameter name	Value	Meaning
LED behavior (PWR) at V2 undervoltage	0	Red PWR-LED constant red at V2 undervoltage.
	1	green PWR-LED is blinking green at V2 undervoltage.
ETH x Port Setup	0	Auto negotiation The port is set to autonegotiation.
	1	100BT/FD Fix setting of the communication parameters for the Ethernet port to: 100BaseT full duplex

Input Assembly Instances

EtherNet/IP Connection	Input Assembly		Device status (in byte)	Basic I/O (in byte)	IO-Link inputs (in byte)	Diagnostics (in byte)	Event data (in byte)
	Instance	Size (in 8 bit)					
Exclusive Owner	103	346	2	4	256	20	64
Input Only	103	346	2	4	256	20	64
Exclusive Owner (Omron)	103	346	2	4	256	20	64
Exclusive owner, IOL 4 IN/4 OUT, diagnostics	120	58	2	4	32	20	0
Exclusive owner, IOL 6 IN/6 OUT, diagnostics	122	74	2	4	48	20	0
Exclusive owner, IOL 8 IN/8 OUT, diagnostics	124	90	2	4	64	20	0
Exclusive owner, IOL 4 IN/4 OUT	121	38	2	4	32	0	0
Exclusive owner, IOL 6 IN/6 OUT	123	54	2	4	48	0	0
Exclusive owner, IOL 8 IN/8 OUT	125	70	2	4	64	0	0

Input instance 103 – standard input

The description of the input data can be found in chapter "Operating".

Word no.	Bit no.															
	15	14	13	12	11	10	9	8	7	6	5	4	3	2	1	0
Status word																
0x00	FCE	-	-	-	-	-	V1	-	V2	-	-	-	-	-	AR GEE	DIAG
Inputs																
0x01	-	DI14 (SIO)	-	DI12 (SIO)	-	DI10 (SIO)	-	DI8 (SIO)	DXP7	DI6 (SIO)	DXP5	DI4 (SIO)	DXP3	DI2 (SIO)	DXP1	DI0 (SIO)
Process data valid																
0x02	-	DVS 14	-	DVS 12	-	DVS 10	-	DVS8	-	DVS6	-	DVS4	-	DVS2	-	DVS0
IO-Link process input data																
0x03... 0x12 ... 0x72... 0x82	16 words per port															
Diagnostics																
VAUX1/VAUX2																
0x83	VERR V2 C7 Ch15	VERR V2 C6 Ch13	VERR V2 C5 Ch11	VERR V2 C4 Ch9	-	-	-	-	VERR V1 C7 Ch14	VERR V1 C6 Ch12	VERR V1 C5 Ch10	VERR V1 C4 Ch8	VERR V1 C3 Ch6/7	VERR V1 C2 Ch4/5	VERR V1 C1 Ch2/3	VERR V1 C0 Ch0/1
DXP channels																
0x84	-	-	-	-	-	-	-	-	ERR DXP 7	-	ERR DXP 5	-	ERR DXP 3	-	ERR DXP 1	-
IO-Link port diagnostics																
Port 1																
0x85	GEN ERR	OVL	V HIGH	V LOW	UL VE	LL VU	O TMP	PRM ERR	EVT2	EVT1	PD INV	HW ERR	DS ERR	CFG ERR	PPR	-
...																
Port 8																
0x8C	GEN ERR	OVL	V HIGH	V LOW	UL VE	LL VU	O TMP	PRM ERR	EVT2	EVT1	PD INV	HW ERR	DS ERR	CFG ERR	PPR	-
IO-Link Events																
0x8D	Port (1st Event)								Qualifier (1st Event)							
0x8E	Event Code low byte (1st Event)								Event Code high byte (1st event)							
...																
0xAB	Port 16th event)								Qualifier (16th event)							
0xAC	Event Code low byte (16th event)								Event Code high byte (16th event)							

Instance 120 – 4 byte IN, diagnostics

The description of the input data can be found in chapter "Operating".

Word no.	Bit no.															
	15	14	13	12	11	10	9	8	7	6	5	4	3	2	1	0
Status word																
0x00	FCE	-	-	-	-	-	V1	-	V2	-	-	-	-	-	AR GEE	DIAG
Inputs																
0x01	-	DI14 (SIO)	-	DI12 (SIO)	-	DI10 (SIO)	-	DI8 (SIO)	DXP7	DI6 (SIO)	DXP5	DI4 (SIO)	DXP3	DI2 (SIO)	DXP1	DI0 (SIO)
Process data valid																
0x02	-	DVS 14	-	DVS 12	-	DVS 10	-	DVS8	-	DVS6	-	DVS4	-	DVS2	-	DVS0
IO-Link process input data																
0x03... 0x04 ... 0x11... 0x12	2 words per port															
Diagnostics																
VAUX1/VAUX2																
0x13	VERR V2 C7 Ch15	VERR V2 C6 Ch13	VERR V2 C5 Ch11	VERR V2 C4 Ch9	-	-	-	-	VERR V1 C7 Ch14	VERR V1 C6 Ch12	VERR V1 C5 Ch10	VERR V1 C4 Ch8	VERR V1 C3 Ch6/7	VERR V1 C2 Ch4/5	VERR V1 C1 Ch2/3	VERR V1 C0 Ch0/1
DXP channels																
0x14	-	-	-	-	-	-	-	-	ERR DXP 7	-	ERR DXP 5	-	ERR DXP 3	-	ERR DXP 1	-
IO-Link port diagnostics																
Port 1																
0x15	GEN ERR	OVL	V HIGH	V LOW	UL VE	LL VU	O TMP	PRM ERR	EVT2	EVT1	PD INV	HW ERR	DS ERR	CFG ERR	PPR	-
...																
Port 8																
0x1C	GEN ERR	OVL	V HIGH	V LOW	UL VE	LL VU	O TMP	PRM ERR	EVT2	EVT1	PD INV	HW ERR	DS ERR	CFG ERR	PPR	-

Instance 121 – 4 byte IN

The description of the input data can be found in chapter "Operating".

Word no.	Bit no.															
	15	14	13	12	11	10	9	8	7	6	5	4	3	2	1	0
Status word																
0x00	FCE	-	-	-	-	-	V1	-	V2	-	-	-	-	-	AR GEE	DIAG
Inputs																
0x01	-	DI14 (SIO)	-	DI12 (SIO)	-	DI10 (SIO)	-	DI8 (SIO)	DXP7	DI6 (SIO)	DXP5	DI4 (SIO)	DXP3	DI2 (SIO)	DXP1	DI0 (SIO)
Process data valid																
0x02	-	DVS 14	-	DVS 12	-	DVS 10	-	DVS8	-	DVS6	-	DVS4	-	DVS2	-	DVS0
IO-Link process input data																
0x03...	2 words per port															
0x04																
...																
0x11...																
0x12																

Instance 122 – 6 byte IN, diagnostics

The description of the input data can be found in chapter "Operating".

Word no.	Bit no.															
	15	14	13	12	11	10	9	8	7	6	5	4	3	2	1	0
Status word																
0x00	FCE	-	-	-	-	-	V1	-	V2	-	-	-	-	-	ARGEE	DIAG
Inputs																
0x01	-	DI14 (SIO)	-	DI12 (SIO)	-	DI10 (SIO)	-	DI8 (SIO)	DXP7	DI6 (SIO)	DXP5	DI4 (SIO)	DXP3	DI2 (SIO)	DXP1	DI0 (SIO)
Process data valid																
0x02	-	DVS 14	-	DVS 12	-	DVS 10	-	DVS8	-	DVS6	-	DVS4	-	DVS2	-	DVS0
IO-Link process input data																
0x03... 0x05	3 words per port															
0x06... 0x08																
0x09... 0x0B																
0x0C ...0x0E																
0x0F... 0x11																
0x12... 0x14																
0x15... 0x17																
0x18... 0x1A																
Diagnostics																
VAUX1/VAUX2																
0x1B	VERR V2 C7 Ch15	VERR V2 C6 Ch13	VERR V2 C5 Ch11	VERR V2 C4 Ch9	-	-	-	-	VERR V1 C7 Ch14	VERR V1 C6 Ch12	VERR V1 C5 Ch10	VERR V1 C4 Ch8	VERR V1 C3 Ch6/7	VERR V1 C2 Ch4/5	VERR V1 C1 Ch2/3	VERR V1 C0 Ch0/1
DXP channels																
0x1C	-	-	-	-	-	-	-	-	ERR DXP 7	-	ERR DXP 5	-	ERR DXP 3	-	ERR DXP 1	-
IO-Link port diagnostics																
Port 1																
0x1D	GEN ERR	OVL	V HIGH	V LOW	UL VE	LL VU	O TMP	PRM ERR	EVT2	EVT1	PD INV	HW ERR	DS ERR	CFG ERR	PPR	-
...																
Port 8																
0x24	GEN ERR	OVL	V HIGH	V LOW	UL VE	LL VU	O TMP	PRM ERR	EVT2	EVT1	PD INV	HW ERR	DS ERR	CFG ERR	PPR	-

Instance 123 – 6 byte IN

The description of the input data can be found in chapter "Operating".

Word no.	Bit no.															
	15	14	13	12	11	10	9	8	7	6	5	4	3	2	1	0
Status word																
0x00	FCE	-	-	-	-	-	V1	-	V2	-	-	-	-	-	ARGEE	DIAG
Inputs																
0x01	-	DI14 (SIO)	-	DI12 (SIO)	-	DI10 (SIO)	-	DI8 (SIO)	DXP7	DI6 (SIO)	DXP5	DI4 (SIO)	DXP3	DI2 (SIO)	DXP1	DI0 (SIO)
Process data valid																
0x02	-	DVS 14	-	DVS 12	-	DVS 10	-	DVS8	-	DVS6	-	DVS4	-	DVS2	-	DVS0
IO-Link process input data																
0x03...	3 words per port															
0x05																
...																
0x18...																
0x1A																

Instance 124 – 8 byte IN, diagnostics

The description of the input data can be found in chapter "Operating".

Word no.	Bit no.															
	15	14	13	12	11	10	9	8	7	6	5	4	3	2	1	0
Status word																
0x00	FCE	-	-	-	-	-	V1	-	V2	-	-	-	-	-	ARGEE	DIAG
Inputs																
0x01	-	DI14 (SIO)	-	DI12 (SIO)	-	DI10 (SIO)	-	DI8 (SIO)	DXP7	DI6 (SIO)	DXP5	DI4 (SIO)	DXP3	DI2 (SIO)	DXP1	DI0 (SIO)
Process data valid																
0x02	-	DVS 14	-	DVS 12	-	DVS 10	-	DVS8	-	DVS6	-	DVS4	-	DVS2	-	DVS0
IO-Link process input data																
0x03... 0x06 ... 0x1F... 0x22	4 words per port															
Diagnostics																
VAUX1/VAUX2																
0x23	VERR V2 C7 Ch15	VERR V2 C6 Ch13	VERR V2 C5 Ch11	VERR V2 C4 Ch9	-	-	-	-	VERR V1 C7 Ch14	VERR V1 C6 Ch12	VERR V1 C5 Ch10	VERR V1 C4 Ch8	VERR V1 C3 Ch6/7	VERR V1 C2 Ch4/5	VERR V1 C1 Ch2/3	VERR V1 C0 Ch0/1
DXP channels																
0x24	-	-	-	-	-	-	-	-	ERR DXP 7	-	ERR DXP 5	-	ERR DXP 3	-	ERR DXP 1	-
IO-Link port diagnostics																
Port 1																
0x25	GEN ERR	OVL	V HIGH	V LOW	UL VE	LL VU	O TMP	PRM ERR	EVT2	EVT1	PD INV	HW ERR	DS ERR	CFG ERR	PPR	-
...																
Port 8																
0x2C	GEN ERR	OVL	V HIGH	V LOW	UL VE	LL VU	O TMP	PRM ERR	EVT2	EVT1	PD INV	HW ERR	DS ERR	CFG ERR	PPR	-

Instance 125 – 8 byte IN

The description of the input data can be found in chapter "Operating".

Word no.	Bit no.															
	15	14	13	12	11	10	9	8	7	6	5	4	3	2	1	0
Status word																
0x00	FCE	-	-	-	-	-	V1	-	V2	-	-	-	-	-	ARGEE	DIAG
Inputs																
0x01	-	DI14 (SIO)	-	DI12 (SIO)	-	DI10 (SIO)	-	DI8 (SIO)	DXP7	DI6 (SIO)	DXP5	DI4 (SIO)	DXP3	DI2 (SIO)	DXP1	DI0 (SIO)
Process input data valid																
0x02	-	DVS 14	-	DVS 12	-	DVS 10	-	DVS8	-	DVS6	-	DVS4	-	DVS2	-	DVS0
IO-Link process input data																
0x03...	4 words per port															
0x06																
...																
0x1F...																
0x22																

Output assembly instances

EtherNet/IP Connection	Output Assembly		Control word (in byte)	DXP outputs (in byte)	IO-Link outputs (in byte)	VAUX (in byte)
	Instance	Size (in 8 bit)				
Exclusive Owner	104	262	2	2	256	2
Exclusive owner, IOL 4 IN/4 OUT	150	38	2	2	32	2
Exclusive owner, IOL 6 IN/6 OUT	151	54	2	2	48	2
Exclusive owner, IOL 8 IN/8 OUT	152	70	2	2	64	2

Instance 104 – standard output

The description of the input data can be found in chapter "Operating".

Word no.	Bit no.															
	15	14	13	12	11	10	9	8	7	6	5	4	3	2	1	0
Control word																
0x00	reserverd															
DXP outputs																
0x01	-	-	-	-	-	-	-	-	DXP7	-	DXP5	-	DXP3	-	DXP1	-
IO-Link process output data																
0x02... 0x11	16 words per port															
...																
0x72... 0x81																
VAUX1/VAUX2																
0x82	VAUX 2 Pin2 C7 (ch15)	VAUX 2 Pin2 C6 (ch13)	VAUX 2 Pin2 C5 (ch11)	VAUX 2 Pin2 C4 (ch9)	-	-	-	-	VAUX 1 Pin1 C7 (ch14)	VAUX 1 Pin1 C6 (ch12)	VAUX 1 Pin1 C5 (ch10)	VAUX 1 Pin1 C4 (ch8)	VAUX1 Pin1 C3 (ch6/7)	VAUX1 Pin1 C2 (ch2/5)	VAUX1 Pin1 C1 (ch2/3)	VAUX1 Pin1 C0 (ch0/1)

Instance 150 – 4 byte OUT

The description of the input data can be found in chapter "Operating".

Word no.	Bit no.															
	15	14	13	12	11	10	9	8	7	6	5	4	3	2	1	0
Control word																
0x00	reserverd															
DXP outputs																
0x01	-	-	-	-	-	-	-	-	DXP7	-	DXP5	-	DXP3	-	DXP1	-
IO-Link process output data																
0x02...	2 words per port															
0x03																
...																
0x10...																
0x11																
VAUX1/VAUX2																
0x12	VAUX 2 pin2 C7 (ch15)	VAUX 2 pin2 C6 (ch13)	VAUX 2 pin2 C5 (ch11)	VAUX 2 pin2 C4 (ch9)	-	-	-	-	VAUX 1 pin1 C7 (ch14)	VAUX 1 pin1 C6 (ch12)	VAUX 1 pin1 C5 (ch10)	VAUX 1 pin1 C4 (ch8)	VAUX1 pin1 C3 (ch6/7)	VAUX1 pin1 C2 (ch4/5)	VAUX1 pin1 C1 (ch2/3)	VAUX1 pin1 C0 (ch0/1)

Instance 151 – 6 byte OUT

The description of the input data can be found in chapter "Operating".

Word no.	Bit no.															
	15	14	13	12	11	10	9	8	7	6	5	4	3	2	1	0
Control word																
0x00	reserverd															
DXP outputs																
0x01	-	-	-	-	-	-	-	-	DXP7	-	DXP5	-	DXP3	-	DXP1	-
IO-Link process output data																
0x02...	3 words per port															
0x04																
...																
0x17...																
0x19																
VAUX1/VAUX2																
0x1A	VAUX 2 pin2 C7 (ch15)	VAUX 2 pin2 C6 (ch13)	VAUX 2 pin2 C5 (ch11)	VAUX 2 pin2 C4 (ch9)	-	-	-	-	VAUX 1 pin1 C7 (ch14)	VAUX 1 pin1 C6 (ch12)	VAUX 1 pin1 C5 (ch10)	VAUX 1 pin1 C4 (ch8)	VAUX1 pin1 C3 (ch6/7)	VAUX1 pin1 C2 (ch4/5)	VAUX1 pin1 C1 (ch2/3)	VAUX1 pin1 C0 (ch0/1)

Instance 152 – 8 byte OUT

The description of the input data can be found in chapter "Operating".

Word no.	Bit no.															
	15	14	13	12	11	10	9	8	7	6	5	4	3	2	1	0
Control word																
0x00	reserverd															
DXP outputs																
0x01	-	-	-	-	-	-	-	-	DXP7	-	DXP5	-	DXP3	-	DXP1	-
IO-Link process output data																
0x02...	4 words per port															
0x05																
...																
0x1E...																
0x21																
VAUX1/VAUX2																
0x22	VAUX 2 pin2 C7 (ch15)	VAUX 2 pin2 C6 (ch13)	VAUX 2 pin2 C5 (ch11)	VAUX 2 pin2 C4 (ch9)	-	-	-	-	VAUX 1 pin1 C7 (ch14)	VAUX 1 pin1 C6 (ch12)	VAUX 1 pin1 C5 (ch10)	VAUX 1 pin1 C4 (ch8)	VAUX1 pin1 C3 (ch6/7)	VAUX1 pin1 C2 (ch4/5)	VAUX1 pin1 C1 (ch2/3)	VAUX1 pin1 C0 (ch0/1)

Connection Manager Object (0x06)

This object is used for connection and connectionless communications, including establishing connections across multiple subnets.

The following description of the Ethernet Link Object is taken from the CIP specification, Vol. 2, Rev. 2.1 by ODVA & ControlNet International Ltd. and adapted to the Turck products.

Common services

Service code		Class	Instance	Meaning
Dec.	Hex.			
84	0x54	No	Yes	FWD_OPEN_CMD (opens a connection)
78	0x4E	No	Yes	FWD_CLOSE_CMD (closes a connection)
82	0x52	No	Yes	UNCONNECTED_SEND_CMD

TCP/IP Interface Object (0xF5)

The following description of the Ethernet Link Object is taken from the CIP specification, Vol. 2, Rev. 1.1 by ODVA & ControlNet International Ltd. and adapted to the Turck products.

Class attributes

Attr. no. Dec.	Hex.	Designation	Get/Set	Type	Value
1	0x01	Revision	G	UINT	1
2	0x02	Max. object instance	G	UINT	1
3	0x03	Number of instances	G	UINT	1
6	0x06	Max. class identifier	G	UINT	7
7	0x07	Max. instance attribute	G	UINT	6

Instance Attributes

Attr. no. Dec.	Hex.	Designation	Get/Set	Type	Value
1	0x01	Status	G	DWORD	Interface status
2	0x02	Configuration capability	G	DWORD	Interface capability flag
3	0x03	Configuration control	G/S	DWORD	Interface control flag
4	0x04	Physical link object	G	STRUCT	
		Path size		UINT	Number of 16 bit words: 0x02
		Path		Padded EPATH	0x20, 0xF6, 0x24, 0x01
5	0x05	Interface configuration	G	Structure of:	TCP/IP network interface configuration
		IP address		UDINT	Actual IP address
		Network mask		UDINT	Actual network mask
		Gateway addr.		UDINT	Actual default gateway
		Name server		UDINT	0 = no server address configured
		Name server 2		UDINT	0 = no secondary server address configured
Domain name	UDINT	0 = no Domain Name configured			
6	0x06	Host name	G	STRING	0 = no host name configured
12	0x0C	QuickConnect	G/S	BOOL	0 = deactivate 1 = activate

Common services

Service code		Class	Instance	Meaning
Dec.	Hex.			
1	0x01	Yes	Yes	Get_Attribute_All
2	0x02	No	No	Set_Attribute_All
14	0x0E	Yes	Yes	Get_Attribute_Single
16	0x10	No	Yes	Set_Attribute_Single

Interface Status

The Status attribute indicates the status of the TCP/IP network interface.

Bit	Designation	Meaning
0...3	Interface configuration status	Indicates the status of the Interface Configuration attribute: 0 = The Interface Configuration attribute has not been configured 1 = The Interface Configuration attribute contains valid configuration. 2...15 = reserved
4...31	Reserved	

Configuration Capability

The Configuration Capability indicates the device's support for optional network configuration capability.

Bit	Designation	Meaning	Value
0	BOOTP client	The device is capable of obtaining its network configuration via BOOTP.	1
1	DNS client	The device is capable of resolving host names by querying a DNS server.	0
2	DHCP client	The device is capable of obtaining its network configuration via DHCP.	1

Configuration control

The Configuration Control attribute is used to control network configuration options.

Bit	Designation	Meaning
0...3	Startup configuration	Determines how the device shall obtain its initial configuration. 0 = The device shall use the interface configuration values previously stored (for example, in non-volatile memory or via hardware switches, etc). 1...3 = reserved
4	DNS Enable	Always 0
5...31	Reserved	Set to 0

Interface Configuration

This attribute contains the configuration parameters required to operate a TCP/IP device.

To change this attribute, proceed as follows:

- ▶ Read out the attribute.
- ▶ Change the parameters.
- ▶ Set the attribute.
- ⇒ The TCP/IP Interface Object applies the new configuration upon completion of the Set service. If the value of the Startup Configuration bits (Configuration Control attribute) is 0, the new configuration is stored in non-volatile memory.

The device does not reply to the set service until the values are safely stored to non-volatile memory.

An attempt to set any of the components of the Interface Configuration attribute to invalid values results in an error (status code 0x09) returned from the Set service. If initial configuration is obtained via BOOTP or DHCP, the Interface Configuration attribute components are all 0 until the BOOTP or DHCP reply is received. Upon receipt of the BOOTP or DHCP reply, the Interface Configuration attribute shows the configuration obtained via BOOTP/DHCP.

Host name

This attribute contains the device's host name. The host name attribute is used when the device supports the DHCP-DNS Update capability and has been configured to use DHCP upon start up. The mechanism allows the DHCP client to transmit its host name to the DHCP server. The DHCP server then updates the DNS records on behalf of the client.

Ethernet Link Object (0xF6)

The following description of the Ethernet Link Object is taken from the CIP specification, Vol. 2, Rev. 1.1 by ODVA & ControlNet International Ltd. and adapted to the Turck products.

Class attributes

Attr.-no.	Designation	Get/Set	Type	Value	
Dec.	Hex.				
1	0x01	Revision	G	UINT	1
2	0x02	Max. object instance	G	UINT	1
3	0x03	Number of instances	G	UINT	1
6	0x06	Max. class identifier	G	UINT	7
7	0x07	Max. instance attribute	G	UINT	6

Instance attributes

Attr.-no.	Designation	Get/Set	Type	Value	
Dec.	Hex.				
1	0x01	Interface speed	G	UDINT	Speed in megabit per second (e.g. 10, 100, 1000 etc.)
2	0x02	Interface flags	G	DWORD	Interface capability flag
3	0x03	Physical address	G	ARRAY OF USINT	Contains the interface's MAC address (Turck: 00:07:46:xx:xx:xx)
6	0x06	Interface control	G	2 WORD	Allows port-wise changes of the Ethernet-settings
7	0x07	Interface type	G		
10	0x0A	Interface label	G		

Interface flags

Bit	Designation	Meaning	Default value
0	Link status	Indicates whether or not the Ethernet communications interface is connected to an active network. 0 = inactive link 1 = active link	Depends on application
1	Half/full duplex	0 = Half duplex 1 = Full duplex If the Link Status flag is 0, the value of the Half/Full Duplex flag is indeterminate.	Depends on application
2...4	Negotiation status	Indicates the status of the automatic auto-negotiation 0 = autonegotiation in progress 1 = autonegotiation and speed detection failed, using default values for speed and duplex (10 Mbps/half duplex). 2 = auto-negotiation failed but detected speed (default: half duplex). 3 = successfully negotiated speed and duplex 4 = autonegotiation not started, yet. Forced speed and duplex.	Depends on application

Bit	Designation	Meaning	Default value
5	Manual setting requires reset	0 = interface can activate changes to link parameters (auto-negotiate, duplex mode, interface speed) automatically 1 = device requires a Reset service to be issued to its Identity Object in order to adapt the changes.	0
6	Local Hardware Fault	0 = interface detects no local hardware fault 1 = local hardware error detected	0

Common services

Service code		Class	Instance	Meaning
Dec.	Hex.			
1	0x01	Yes	Yes	Get_Attribute_All
14	0x0E	Yes	Yes	Get_Attribute_Single
76	0x4C	No	Yes	Enetlink_Get_and_Clear

7.6.7 VSC-Vendor Specific Classes

In addition to supporting the above named CIP Standard Classes, the device support the vendor specific classes (VSCs) described in the following.

Class Code		Name	Description
dec.	Hex.		
100	0x64	Gateway Class [▶ 105]	Data and parameters for the fieldbus specific part of the device.
103	0x67	IO-Link Parameter Object [▶ 107]	ISDU object for acyclic transmission of parameter data between IO-Link master and IO-Link device
137	0x89	IO-Link Port Class [▶ 112]	Parameters and diagnostics of the IO-Link channels
138	0x8A	IO-Link Events Class [▶ 114]	IO-Link Events
153	0x99	Basic Class [▶ 114]	Parameters and diagnostics of the digital channels channels
161	0xA1	VAUX Control Class [▶ 116]	Parameters and diagnostics for VAUX

Gateway Class (VSC 100)

Object instance

Attr. no.		Designation	Get/Set	Type	Meaning
Dec.	Hex.				
100	0x64	Max. object attribute	G	USINT	Number of the last object attribute to be implemented
101	0x65	Hardware revision	G	STRUCT	Hardware revision number of of the device (USINT Maj./USINT Min.)
102	0x66	Firmware revision	G	STRUCT	Firmware revision of the boot firmware (maj./min.).
103	0x67	Service tool ident number	G	UDINT	BOOT-ID (identification number)
104	0x68	Hardware Info	G	STRUCT	Module hardware information (UINT)

Object instance 2, gateway instance

Attr. no.		Designation	Get/Set	Type	Meaning
Dec.	Hex.				
109	0x6D	Device status	G	STRUCT	Contains the device status.
115	0x73	On IO connection timeout	G/S	ENUM USINT	Reaction when the time limit for an I/O connection is exceeded: 0: SWITCH IO FAULTED (0): The channels are switched to substitute value. 1: SWITCH IO OFF (1): The outputs are switched to 0. 2: SWITCH IO HOLD (2): No further changes to I/O data. The outputs are held.

Attr. no.		Designation	Get/Set	Type	Meaning
Dec.	Hex.				
138	0x8A	GW status register	G/S	DWORD	Activates or deactivates the mapping of the status word into the device's input data. Activating or deactivating of the status word is only possible in Assembly Instance 103.
139	0x8B	GW control register	G/S	DWORD	Activates or deactivates the mapping of the control word into the device's output data. Activating or deactivating of the control word is only possible in Assembly Instance 104.
140	0x8C	Disable protocols	G/S	UINT	Deactivation of the used Ethernet protocol. Bit 0: Deactivates EtherNet/IP (cannot be deactivated via the EtherNet/IP interface). Bit 1: Deactivates Modbus TCP Bit 2: Deactivates PROFINET Bit 15: Deactivates the web server
141	0x8D	LED behavior (PWR) at V2 undervoltage	G/S	USINT	0: Red 1: Green flashing

IO-Link Parameter Object (VSC 103)

The IO-Link Parameter Object enables the acyclic transfer of parameter data between the IO-Link master and the IO-Link device.

Instance 1 of the object addresses the IO-Link master

The instance attribute numbers address the IO-Link port at the IO-Link master or the port 0 functions of the IO-Link master.

- 1...n: IO-Link port at IO-Link master, n = number of IO-Link ports at IO-Link master
- 128: Port-0 functions of the IO-Link master

Instance attributes

Common services

Service code	Class	Instance	Service name	
Dec.	Hex.			
14	0x0E	Yes	No	Get_Attribute_Single Returns the content of a specified attribute.
75	0x4B	No	Yes	Read_ISDU The service reads parameters from the connected IO-Link device.
76	0x4C	No	Yes	Write_ISDU The service writes parameters from the connected IO-Link device.

Read_ISDU - Request

Data	Value/content	Description
Class	0x67	IO-Link Parameter Object
Instance	0x01	Addressing the IO-Link master
Instance attribute	0x01...n, 128	IO-Link port number, or 128 for Port-0 functions
Service code	0x4B	Read_ISDU
Data	Request parameters for the ISDU Read Service	
	Name	Data type Description
Data byte 0	Index (LSB)	UINT LSB from index of the IO-Link ISDU object acc. to IODD
Data byte 1	Index (MSB)	UINT MSB from index of the IO-Link ISDU object acc. to IODD
Data byte 2	Sub index	USINT Sub index from the IO-Link ISDU object acc. to IODD

Read_ISDU – Response

- CIP Service Response, General-Status \neq 0 → error-free access structure of the response:

Name	Data type	Description
ISDU data	Array of Byte	Read data, max. 232 byte

- CIP Service Response, General-Status \neq 0 → access error structure of the response:

Name	Data type	Description
IOL_Master Error	UINT	IO-Link master specific, see IO-Link master Error Codes
IOL_Device Error	UINT	IO-Link device specific, see IO-Link device Error Codes and device documentation

Example:

Read access – name of device at port 4 is read out

Data	Value/content	Description
Class	0x67	IO-Link Parameter Object
Instance	0x01	Addressing the IO-Link master
Instance attribute	0x04	IO-Link port number
Service code	0x4B	Read_ISDU: read access
Data	Request parameters for the ISDU Read Service	
	Name	Data type Description
Data byte 0	0x12	UINT Index for the product name in the device (e.g. Turck I/O hub TBIL-M1-16DXP) according to IODD
Data byte 1	0x00	UINT -
Data byte 2	0x00	USINT The index has no sub index.

- CIP Service Response:

Name	Data type	Description
ISDU data	Array of Byte	Error-free access: Content: 54 42 49 4C 2D 4D 31 2D 31 36 44 58 50 (TBIL-M1-16DXP) Access error: Content: Error code

Write_ISDU – Request

Data	Value/content	Description	
Class	0x67	IO-Link Parameter Object	
Instance	0x01	Addressing the IO-Link master	
Instance attribute	0x01...n, 128	IO-Link port number, or 128 for Port-0 functions	
Service code	0x4C	Write_ISDU	
Data	Request parameters for the ISDU write service		
	Name	Data type	Description
Data byte 0	Index (LSB)	UINT	LSB from index of the IO-Link ISDU object acc. to IODD
Data byte 1	Index (MSB)	UINT	MSB from index of the IO-Link ISDU object acc. to IODD
Data byte 2	Sub index	USINT	Sub index from the IO-Link ISDU object acc. to IODD
Data byte 3... data byte n	Data	Array of Byte	Parameter data (n= length of ISDU object + 3)

Write_ISDU – Response

- CIP Service Response, general status = 0 → error-free access
Service response without further data
- CIP Service Response, general status ≠ 0 → access error
structure of the response:

Name	Data type	Description
IOL_Master Error	UINT	IO-Link master specific, see IO-Link master Error Codes
IOL_Device Error	UINT	IO-Link device specific, see IO-Link device Error Codes and device documentation

Example:

Write access – Application Specific Tag is written into the device at port 4

Data	Value/content	Description
Class	0x67	IO-Link Parameter Object
Instance	0x01	Addressing the IO-Link master
Instance attribute	0x04	IO-Link port number
Service code	0x4C	Write_ISDU: Write access
Data	Request parameters for the ISDU write service	
	Name	Data type Description
	0x18	UINT Index for the application specific tag in the device (e.g. In Turck I/O-Hub TBIL-M1- 16DXP)
	0x00	USINT The index has no sub index.
	Byte 0: 0x54 Byte 1: 0x65 Byte 2: 0x6D Byte 3: 0x70 Byte 4: 0x65 ...	The Application Specific Tag of the device can consist of 32 byte, example: ASCII: Temperature_sensor1 Hex: 54 65 6d 70 65 72 61 74 75 72 65 5f 73 65 6e 73 6f 72 31 00 00...
	Byte 17: 0x31 Byte 18...31: 00	The remainder of the 32 bytes not required is filled with 00.

IO-Link master error codes

Error code	Designation acc. to specification	Meaning
0x0000	No error	No error
0x7000	IOL_CALL Conflict	Unexpected write-request, read request expected
0x7001	Wrong IOL_CALL	Decoding error
0x7002	Port blocked	The accessed port is occupied by another task
...	reserved	
0x8000	Timeout	Timeout, IOL master or IOL device port busy
0x8001	Wrong index	Error: IOL index < 32767 or > 65535 selected
0x8002	Wrong port address	Port address not available
0x8002	Wrong port function	Port function not available
...	reserved	

IO-Link device error codes

Error code	Designation acc. to specification	Meaning
0x1000	COM_ERR	Communication error Possible source: the addressed port is parameterized as digital input DI and is not in IO-Link mode
0x1100	I_SERVICE_TIMEOUT	Timeout in communication, device does not respond in time
0x5600	M_ISDU_CHECKSUM	Master reports checksum error, access to device not possible
0x5700	M_ISDU_ILLEGAL	Device can not respond to master request
0x8000	APP_DEV	Application error in the device
0x8011	IDX_NOTAVAIL	Index not available
0x8012	SUBIDX_NOTAVAIL	Sub-Index not available
0x8020	SERV_NOTAVAIL	The service is temporarily not available.
0x8021	SERV_NOTAVAIL_LOCTRL	Service temporarily not available, device is busy (e. g. teaching or parameterization at the device active)
0x8022	SERV_NOTAVAIL_DEVCTRL	Service temporarily not available, device is busy (e. g. teaching or parameterization of the device via DTM/PLC etc. active)
0x8023	IDX_NOT_WRITEABLE	Access denied, index cannot be written
0x8030	PAR_VALOUTOFRNG	Parameter value out of the valid range
0x8031	PAR_VALGTLIM	Parameter value value above the upper limit
0x8032	PAR_VALLTLM	Parameter value value below the lower limit
0x8033	VAL_LENORRRUN	Length of data to be written does not match the length defined for this parameter
0x8034	VAL_LENUNDRUN	
0x8035	FUNC_NOTAVAIL	Function not available in the device
0x8036	FUNC_UNAVAILTEMP	Function temporarily not available in the device
0x8040	PARA_SETINVALID	Invalid parameter: Parameters not consistent with other parameters in the device.
0x8041	PARA_SETINCONSIST	Inconsistent parameters
0x8082	APP_DEVNOTRDY	Application not ready, device busy
0x8100	UNSPECIFIC	Vendor specific, according to device documentation
0x8101... 0x8FF	VENDOR_SPECIFIC	

IO-Link Port Class (VSC 137)

This class provides one instance per IO-Link port at the IO-Link master module.

Attr. no.	Designation	Get/set	Type	Meaning	
Dec.	Hex.				
Parameters					
1	0x01	Operation mode	G/S	USINT	0 = IO-Link without validation 1 = IO-Link with family compatible device 2 = IO-Link with compatible device 3 = IO-Link with identical device 4 = DI (with parameter access) 5...7 = reserved 8 = DI
2	0x02	Data Storage Mode	G/S	USINT	0 = activated 1 = overwrite 2 = read in 3 = deactivated, clear
3	0x03	Cycle time	G/S	USINT	See [▶ 175]
4	0x04	Revision	G/S	USINT	0 = automatic 1 = V 1.0
5	0x05	Activate Quick Start-Up	G/S	USINT	0 = no 1 = yes
6	0x06	Device parameterization via GSD	G/S	USINT	0 = no 1 = yes
7	0x07	Process input data invalid	G/S	USINT	0 = diagnostics generated 1 = no diagnostic generated
8	0x08	Deactivate diagnostics	G/S	USINT	0 = no 1 = notifications 2 = notifications and warnings 3 = yes
9	0x09	Process input data mapping	G/S	USINT	0 = direct 1 = swap16 bit 2 = swap 32 bit 3 = swap all
10	0x0A	Process output data mapping	G/S	USINT	0 = direct 1 = swap16 bit 2 = swap 32 bit 3 = swap all
11	0x0B	Vendor ID	G/S	INT	
12	0x0C	Device ID	G/S	DINT	
Diagnostics					
13	0x0D	Wrong or missing device	G	USINT	0 = inactive 1 = active
14	0x0E	Data storage error	G	USINT	0 = inactive 1 = active
15	0x0F	Process input data invalid	G	USINT	0 = inactive 1 = active
16	0x10	Hardware error	G	USINT	0 = inactive 1 = active

Attr. no. Dec.	Designation Hex.	Get/set	Type	Meaning	
17	0x11	Maintenance events	G	USINT	0 = inactive 1 = active
18	0x12	Out-of-specification events	G	USINT	0 = inactive 1 = active
19	0x13	Parameterization error	G	USINT	0 = inactive 1 = active
20	0x14	Over temperature	G	USINT	0 = inactive 1 = active
21	0x15	Lower limit value underrun	G	USINT	0 = inactive 1 = active
22	0x16	Upper limit value exceeded	G	USINT	0 = inactive 1 = active
23	0x17	Undervoltage	G	USINT	0 = inactive 1 = active
24	0x18	Overvoltage	G	USINT	0 = inactive 1 = active
25	0x19	Overload	G	USINT	0 = inactive 1 = active
26	0x1A	Common error	G	USINT	0 = inactive 1 = active
27	0x1B	Port parameterization error	G	USINT	0 = inactive 1 = active
Process data					
28	0x1C	Input data word 0	G	USINT	
...	G	USINT	
43	0x2B	Input data word 15	G	USINT	
44	0x2C	Output data word 0	G	USINT	
...	G	USINT	
59	0x3B	Output data word 15	G	USINT	

IO-Link Event Class (VSC 138)

Attr. no.	Designation	Get/ Set	Type	Meaning	
Dec.	Hex.				
1	0x01	IO-Link Events – port 1	G	USINT	Port number of the port which sends the 1st IO-Link Event.
...	...				
16	0x10	IO-Link Events – port 16	G	USINT	Port number of the port which sends the 16th IO-Link Event.
17	0x11	IO-Link Events – Qualifier 1	G	USINT	Qualifier of the 1st IO-Link Event
...	...				
32	0x20	IO-Link Events – Qualifier 16	G	USINT	Qualifier of the 16th IO-Link Event
33	0x21	IO-Link Events – Event Code 1	G	USINT	Event Code of the 1st IO-Link Event
...	...				
48	0x30	IO-Link Events – Event Code 16	G	USINT	Event Code of the 16th IO-Link Event

Basic Class (VSC 153)

Attr. no.	Designation	Get/ Set	Type	Meaning	
Dec.	Hex.				
1	0x01	DXP 1 - Manual output reset after overcurrent	G/S	USINT	0 = no 1 = yes
2	0x02	DXP 3 - Manual output reset after overcurrent	G/S	USINT	0 = no 1 = yes
3	0x03	DXP 5 - Manual output reset after overcurrent	G/S	USINT	0 = no 1 = yes
4	0x04	DXP 7 - Manual output reset after overcurrent	G/S	USINT	0 = no 1 = yes
5	0x05	DXP 1 - Activate output	G/S	USINT	0 = no 1 = yes
6	0x06	DXP 3 - Activate output	G/S	USINT	0 = no 1 = yes
7	0x07	DXP 5 - Activate output	G/S	USINT	0 = no 1 = yes
8	0x08	DXP 7 - Activate output	G/S	USINT	0 = no 1 = yes
9	0x09	DXP 1 - Overcurrent output	G	USINT	0 = inactive 1 = active
10	0x0A	DXP 3 - Overcurrent output	G	USINT	0 = inactive 1 = active
11	0x0B	DXP 5 - Overcurrent output	G	USINT	0 = inactive 1 = active
12	0x0C	DXP 7 - Overcurrent output	G	USINT	0 = inactive 1 = active

Attr. no.		Designation	Get/ Set	Type	Meaning
Dec.	Hex.				
13	0x0D	IOL 0 – DI input	G	USINT	0 1
14	0x0E	IOL 2 –DI input	G	USINT	0 1
15	0x0F	IOL 4 – DI input	G	USINT	0 1
16	0x10	IOL 6 – DI input	G	USINT	0 1
17	0x11	IOL 8 – DI input	G	USINT	0 1
18	0x12	IOL 10 – DI input	G	USINT	0 1
19	0x13	IOL 12 – DI input	G	USINT	0 1
20	0x14	IOL 14 – DI input	G	USINT	0 1
21	0x15	IOL0 - Input value valid (Data Valid Signal)	G	USINT	0 = no 1 = yes
22	0x16	IOL0 - Input value valid (Data Valid Signal)	G	USINT	0 = no 1 = yes
23	0x17	IOL4 - Input value valid (Data Valid Signal)	G	USINT	0 = no 1 = yes
24	0x18	IOL6 - Input value valid (Data Valid Signal)	G	USINT	0 = no 1 = yes
25	0x19	IOL8 - Input value valid (Data Valid Signal)	G	USINT	0 = no 1 = yes
26	0x1A	IOL10 - Input value valid (Data Valid Signal)	G	USINT	0 = no 1 = yes
27	0x1B	IOL12 - Input value valid (Data Valid Signal)	G	USINT	0 = no 1 = yes
28	0x1C	IOL14 - Input value valid (Data Valid Signal)	G	USINT	0 = no 1 = yes
29	0x1D	DXP 1 – Input value	G	0 1	
30	0x1E	DXP 3 – Input value	G	0 1	
31	0x1F	DXP 5 – Input value	G	0 1	
32	0x20	DXP 7 – Input value	G	0 1	
33	0x21	DXP 1 – Output value	G	USINT	
34	0x22	DXP 3 – Output value	G	USINT	
35	0x23	DXP 5 – Output value	G	USINT	
36	0x24	DXP 7 – Output value	G	USINT	

VAUX Control Class (VSC 161)

This class contains parameters and diagnostics for the monitoring of 24 VDC sensor and actuator supply.

Attr.-no.		Designation	Get/ Set	Type	Meaning
Dec.	Hex.				
Activate VAUX1 monitoring					
1	0x01	VAUX Control - VAUX1 pin1 C0 (ch0/1)	G/S	USINT	0 = 24 VDC 1 = switchable 2 = off
2	0x02	VAUX Control - VAUX1 pin1 C1 (ch2/3)	G/S	USINT	0 = 24 VDC 1 = switchable 2 = off
3	0x03	VAUX Control - VAUX1 pin1 C2 (ch4/5)	G/S	USINT	0 = 24 VDC 1 = switchable 2 = off
4	0x04	VAUX Control - VAUX1 pin1 C3 (ch6/7)	G/S	USINT	0 = 24 VDC 1 = switchable 2 = off
5	0x05	VAUX Control - VAUX1 pin1 C4 (ch8)	G/S	USINT	0 = 24 VDC 1 = switchable 2 = off
7	0x07	VAUX Control - VAUX1 pin1 C5 (ch10)	G/S	USINT	0 = 24 VDC 1 = switchable 2 = off
9	0x09	VAUX Control - VAUX1 pin1 C6 (ch12)	G/S	USINT	0 = 24 VDC 1 = switchable 2 = off
11	0x0B	VAUX Control - VAUX1 pin1 C7 (ch14)	G/S	USINT	0 = 24 VDC 1 = switchable 2 = off
Activate VAUX2 monitoring					
6	0x06	VAUX Control - VAUX2 pin2 C4 (ch9)	G/S	USINT	0 = 24 VDC 1 = switchable 2 = off
8	0x08	VAUX Control - VAUX2 pin2 C5 (ch11)	G/S	USINT	0 = 24 VDC 1 = switchable 2 = off
10	0x0A	VAUX Control - VAUX2 pin2 C6 (ch13)	G/S	USINT	0 = 24 VDC 1 = switchable 2 = off
12	0x0C	VAUX Control - VAUX2 pin2 C7 (ch15)	G/S	USINT	0 = 24 VDC 1 = switchable 2 = off
VAUX1 status					
13	0x0D	VAUX Control - VAUX1 pin1 C0 (ch0/1)	G	USINT	0 = off 1 = on
14	0x0E	VAUX Control - VAUX1 pin1 C1 (ch2/3)	G	USINT	0 = off 1 = on

Attr.-no.		Designation	Get/ Set	Type	Meaning
Dec.	Hex.				
15	0x0F	VAUX Control - VAUX1 pin1 C2 (ch4/5)	G	USINT	0 = off 1 = on
16	0x10	VAUX Control - VAUX1 pin1 C3 (ch6/7)	G	USINT	0 = off 1 = on
17	0x11	VAUX Control - VAUX1 pin1 C4 (ch8)	G	USINT	0 = off 1 = on
19	0x13	VAUX Control - VAUX1 pin1 C5 (ch10)	G	USINT	0 = off 1 = on
21	0x15	VAUX Control - VAUX1 pin1 C6 (ch12)	G	USINT	0 = off 1 = on
23	0x17	VAUX Control - VAUX1 pin1 C7 (ch14)	G	USINT	0 = off 1 = on
VAUX2 status					
18	0x12	VAUX Control - VAUX2 pin2 C4 (ch9)	G	USINT	0 = off 1 = on
20	0x14	VAUX Control - VAUX2 pin2 C5 (ch11)	G	USINT	0 = off 1 = on
22	0x16	VAUX Control - VAUX2 pin2 C6 (ch13)	G	USINT	0 = off 1 = on
24	0x18	VAUX Control - VAUX2 pin2 C7 (ch15)	G	USINT	0 = off 1 = on

7.7 Connecting the devices to an EtherNet/IP scanner with Studio 5000

Used hardware

The following hardware components are used in this example:

- Rockwell Contoller ControlLogix 1756-L72, Logix 5572
- Rockwell Scanner 1756-EN2TR
- Block module TBEN-L...-8IOL

Used software

The following software tools are used in this example:

- Studio 5000
- Catalog file for Turck compact stations "IOLINK_Vxx_...L5K" as part of the file "TBEN-L_ETH-ERNETIP.zip" (downloadable free of charge under www.turck.com)

Catalog files

Turck provides catalog files (L5K files) for use in Studio5000 from Rockwell Automation. The catalog files contain predefined, application-dependent device configurations with different input and output data widths and descriptions of the configuration, input and output tag data. The predefined device configurations correspond to the input and output assembly instances described in the section "Assembly Object" in the chapter "Commissioning Devices with EtherNet/IP" → under "EtherNet/IP Standard Classes".



NOTE

The catalog file is available in the L5K file format and must be converted to the "ACD" file format before it can be used. The file is opened in Studio5000 and saved as a project (*.ACD).

Prerequisites

- Instance of the programming software Studio5000 with the Catalog files is opened.
- A new project has been created in a second instance of Studio5000.
- The PLC and the Scanner mentioned above have been added to the project in the second instance of Studio5000.

7.7.1 Adding the devices from the catalog files to the new project

- ▶ Right-click the device entry and use **Copy**.

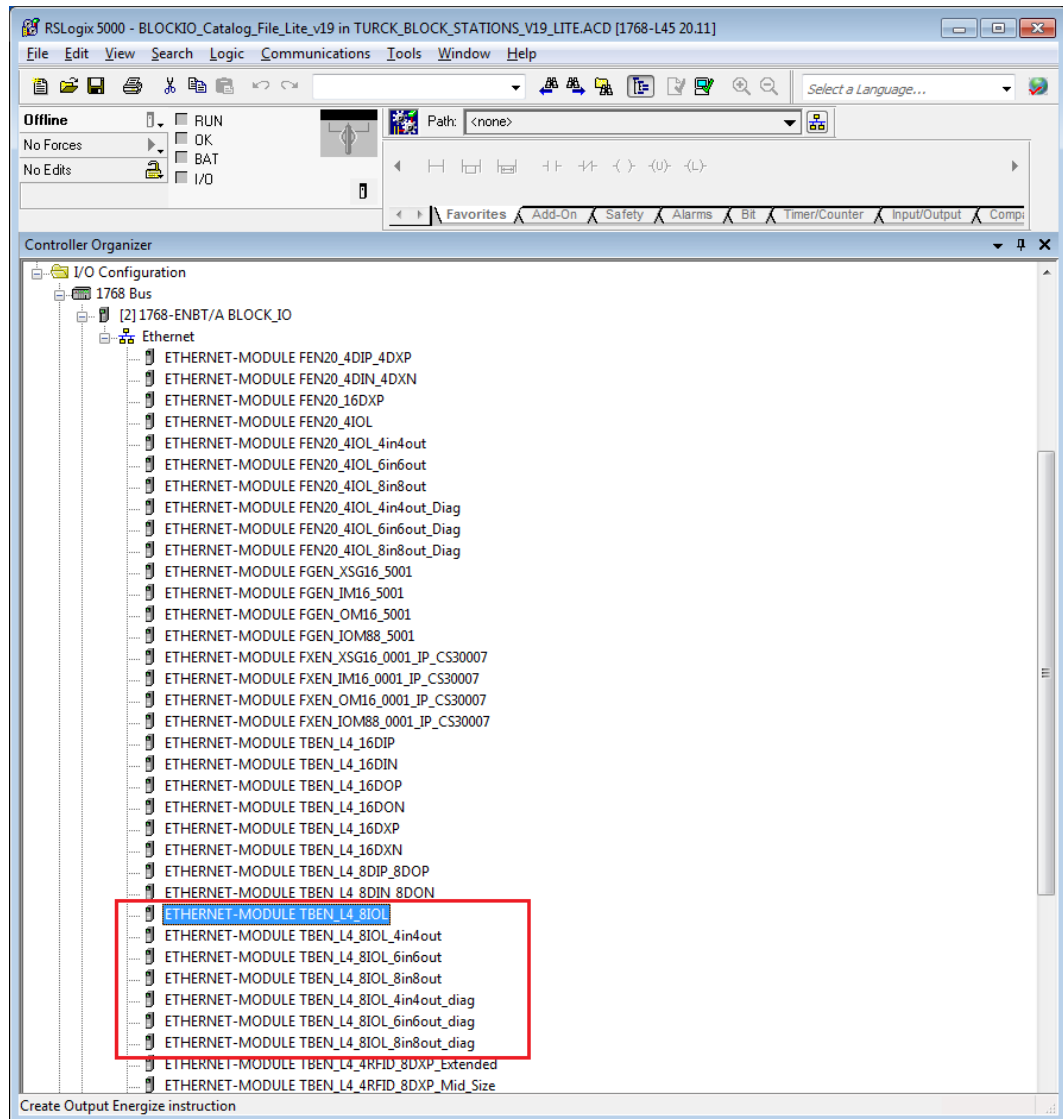

Fig. 64: Copying the device entry from catalog file

- ▶ Right-click the EtherNet/IP-Scanner in the second instance of the software RS Logix and add the device to the project via **Paste**. Here in the example the configuration with 4 byte each input and output data plus diagnostics **TBEN_L..._8IOL_4in4out_diag** is used.

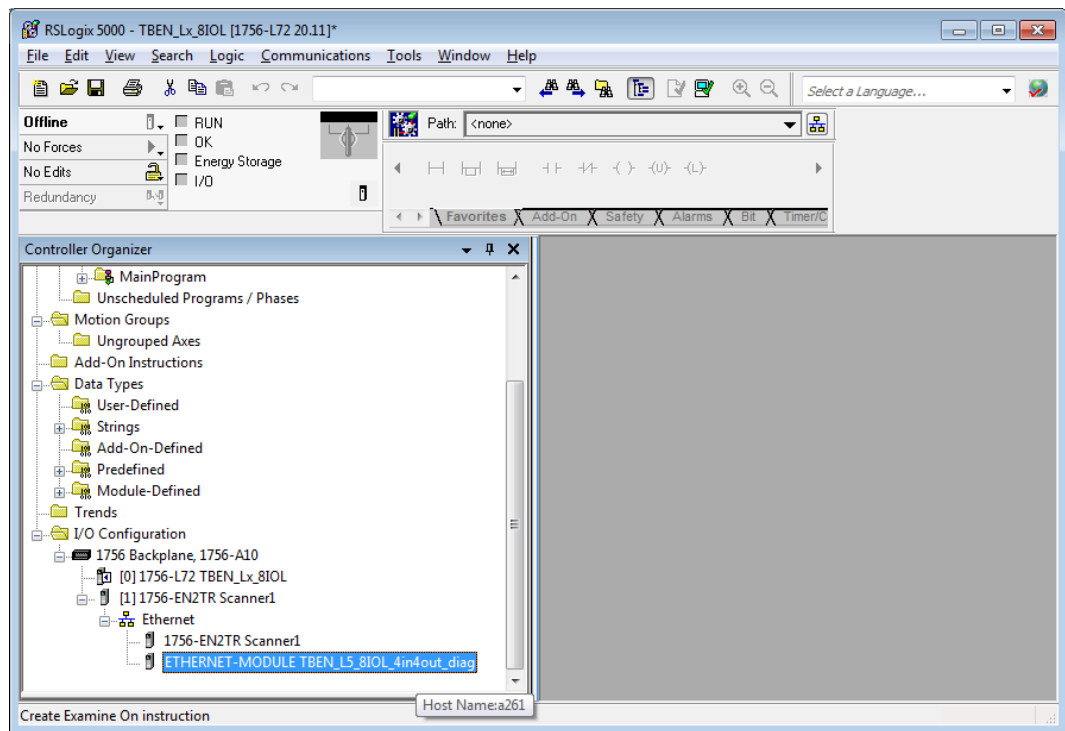

Fig. 65: Predefined configurations of TBEN-L...-8IOL in new project

7.7.2 Configuring the device

- ▶ Open the device entry by double-clicking.
- ▶ If necessary, define a module name.
- ▶ Enter the IP address of the device or a Host Name.

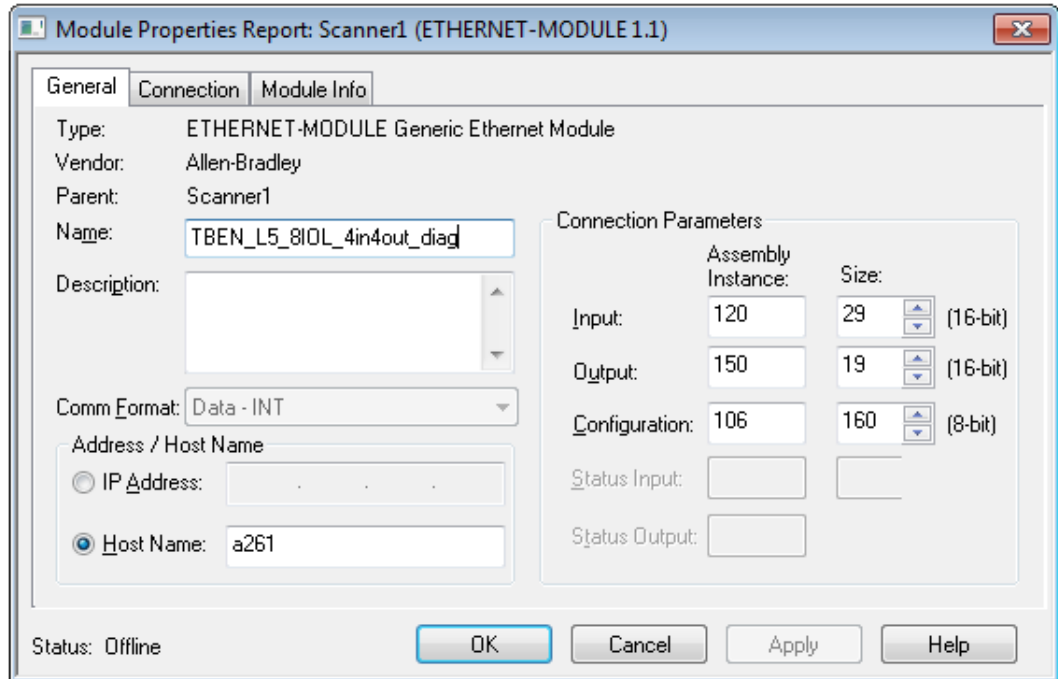

Fig. 66: Setting the module name and the IP address or respectively the host name

- ▶ Optional: Set the connection parameters.

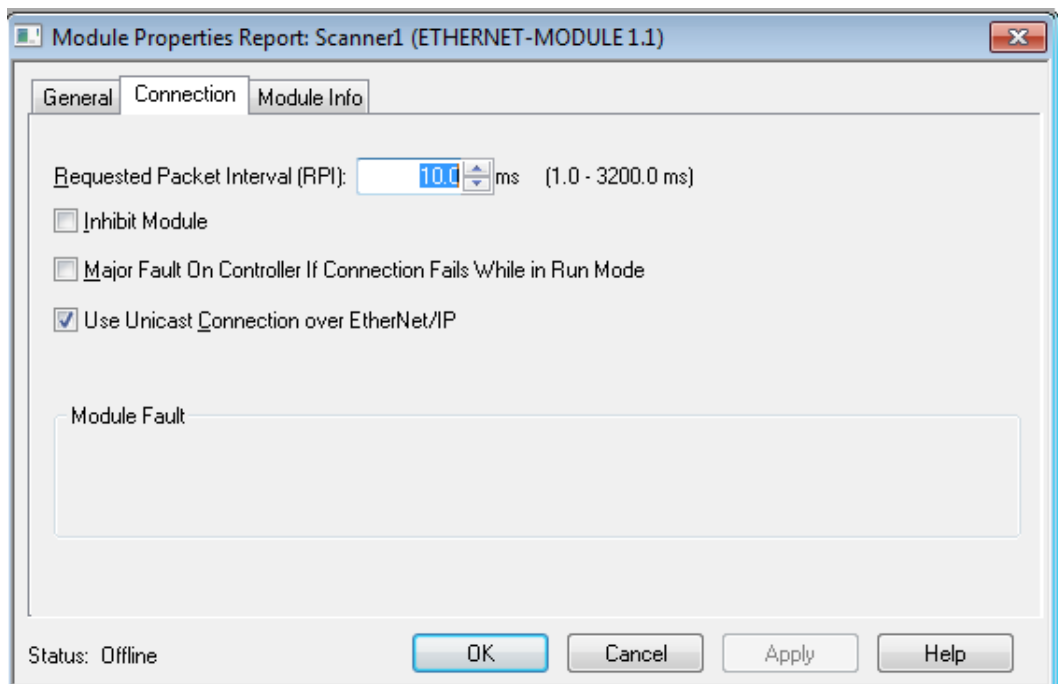

Fig. 67: Setting the connection parameters

7.7.4 Going online with the PLC

- ▶ Search the network via **Who Active** function.
- ▶ Select the PLC.
- ▶ Set the communication path via **Set Project Path**.
- ⇒ The communication path is set

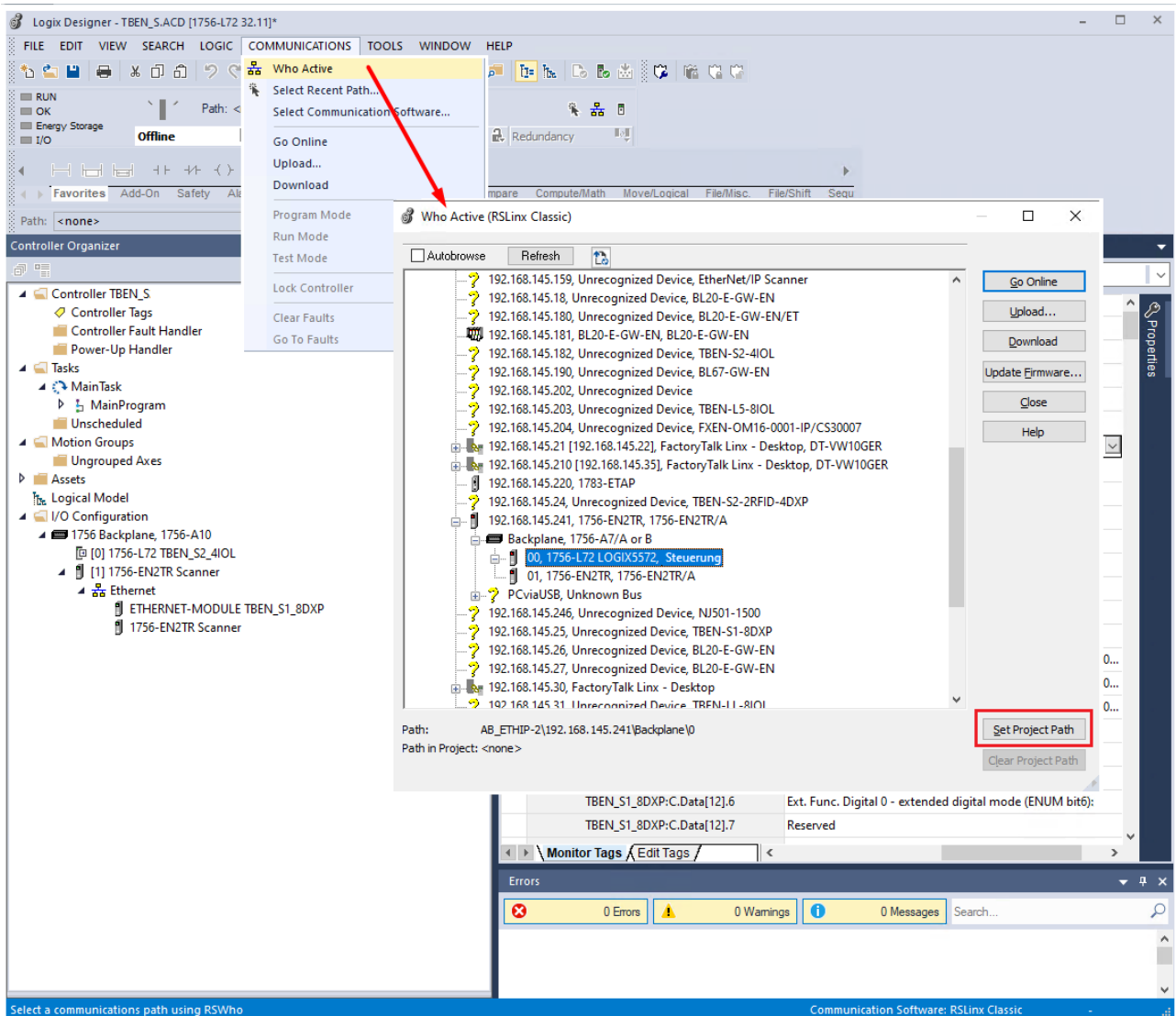

Fig. 69: Setting the communication path

- ▶ Select the PLC.
- ▶ Click **Go online**.

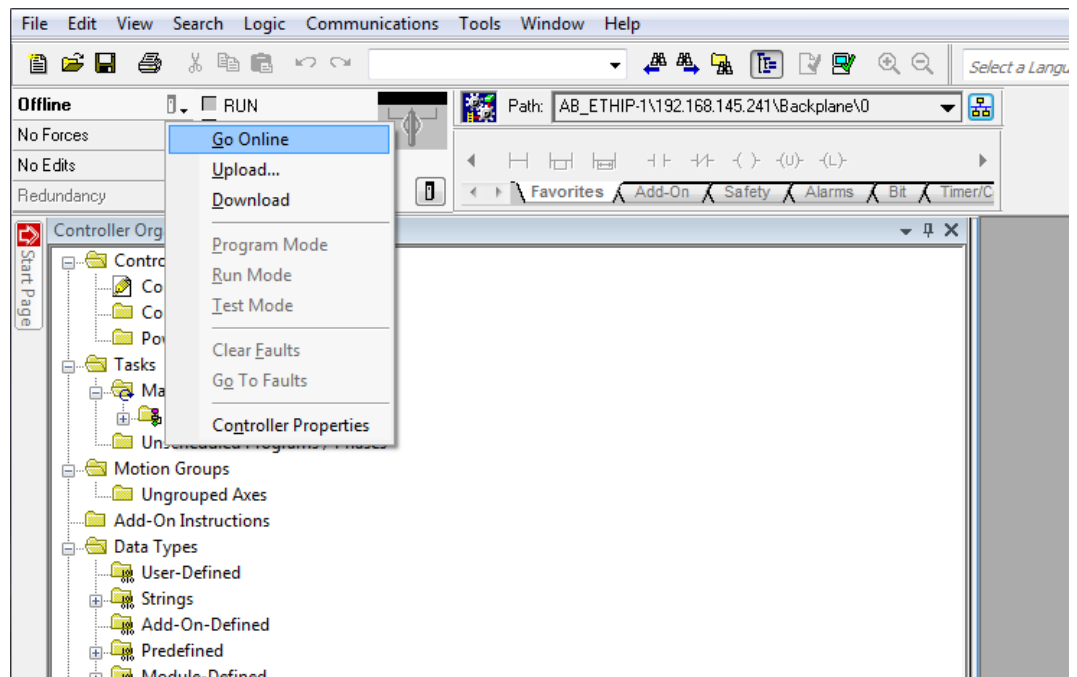

Fig. 70: Going online with the device

- ▶ Click **Download** in the following dialog (Connect To Go Online)
- ▶ Confirm all following messages.
- ⇒ The program is downloaded to the PLC. The online connection is established.

7.7.5 Reading process data

- ▶ Open the Controller Tags in the project tree by double-clicking.
- ⇒ Access to the parameter data (TBEN_L..._8IOL_4in4out_diag:C), input data (TBEN_L..._8IOL_4in4out_diag:I) and output data (TBEN_L..._8IOL_4in4out_diag:O) is possible.

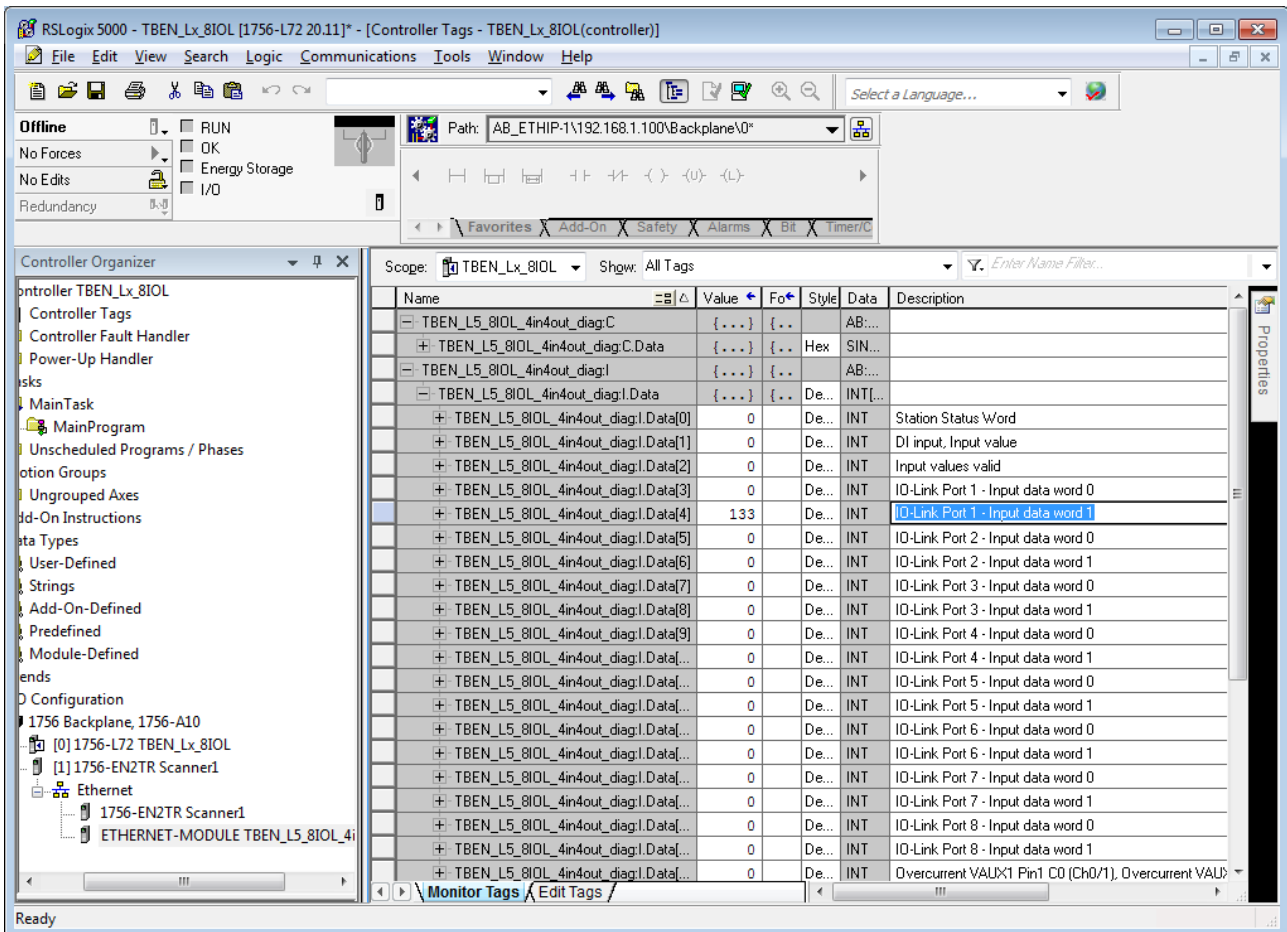

Fig. 71: Controller Tags in the project tree

7.8 Commissioning the devices in CC-Link IE Field Basic

7.8.1 General features CC-Link IE Field Basic

CC-Link IE Field Basic works with a client/server communication model. A maximum data width of 64 × 64 bits is available for communication between a client station and several server stations, whereby a unit of 64 bits is referred to as an occupied station. A CC-Link Field Basic network can consist of a maximum of 64 occupied stations. I/O modules can occupy one or more of the 64 occupied stations, depending on their complexity and data width.

Turck IO-Link master modules of the TBEN-L... series occupy 1...4 occupied stations.

CC-Link IE Field Basic		
Maximum number of stations in a network	max. 64 occupied stations	An I/O module can occupy several occupied stations.
Group	max. 16 occupied stations	To optimize process data traffic, devices can be combined into groups according to their function. A group can consist of a maximum of 16 occupied stations.
Cyclic data		Cyclical data is mapped bit by bit or word by word in registers.
	RX	Register for bit-by-bit access to digital inputs (DI)
	RY	Register for bit-by-bit access to digital outputs (DO)
	RWr	Register for word-by-word, read access to process data (e.g. IO-Link)
	RWw	Register for word-by-word, write access to process data (e.g. IO-Link)
Port numbers	61450 (cyclic data)	
	61451 (port number of server station for NodeSearch and IPAddressSet)	

7.8.2 CSP+ files

The CSP+ files can be downloaded free of charge at www.turck.com.

7.8.3 Cyclic data transmission

The cyclic process image of the devices is divided into a bit area and a word area. The bit area is the same for all device configurations. The word area can vary in size depending on the profile used and, in addition to the IO-Link process data in the input area, can also contain the module status, IO-Link port diagnostics or I/O-Link events. Due to the different process data sizes, the TBEN-L...-8IOL can occupy a different number of stations (occupied stations [▶ 128]).

Input data		
Bit area RX	Word area RWr	Access type
Basic input:	■ IO-Link data	RO
■ Input data of the digital channels (DI and DXP channels)	■ Module diagnostics	
■ Data valid bit of the IO-Link channels	■ IO-Link port diagnostics	
■ Module status	■ IO-Link events	
Output data		
Bit area RY	Word area RWw	Access type
Basic output:	■ IO-Link data	RW
■ Output data of the digital DXP channels		

7.8.4 Occupied Stations

Profile	Occupied stations	Size of the process input data		Size of the process output data	
		Bit area (RX)	Register area (RWr)	Bit area (RY)	Register area (RWw)
1	1	6 byte <ul style="list-style-type: none"> ■ Basic input (DI, DXP + data valid bit): 32 bit ■ Module status: 16 bit 	52 byte <ul style="list-style-type: none"> ■ IO-Link data: 4 byte per port ■ Module diagnostics: 4 byte ■ IO-Link port diagnostics: 2 byte per port 	4 byte: <ul style="list-style-type: none"> ■ Basic output (DXP + deactivate diagnostics): 16 bit ■ VAUX control: 16 bit 	64 byte <ul style="list-style-type: none"> ■ IO-Link data: 8 byte per port
2	2		116 byte <ul style="list-style-type: none"> ■ IO-Link data: 12 byte per port ■ Module diagnostics: 4 byte ■ IO-Link port diagnostics: 2 byte per port 		128 byte <ul style="list-style-type: none"> ■ IO-Link data: 16 byte per port
3	3		180 byte <ul style="list-style-type: none"> ■ IO-Link data: 12 byte per port ■ Module diagnostics: 4 byte ■ IO-Link port diagnostics: 2 byte per port ■ IO-Link events: max. 16 events, 4 byte per event 		192 byte <ul style="list-style-type: none"> ■ IO-Link data: 24 byte per port
4	4		256 byte <ul style="list-style-type: none"> ■ IO-Link data: 32 byte per port 		256 byte <ul style="list-style-type: none"> ■ IO-Link data: 32 byte per port

7.8.5 Bit area

The bit area contains the module status (status word) in the process input data, see [▶ 186] "Basic" and "Module status" [▶ 186] or Status- und Control-Wort. In addition to the output data of the DXP channels, the process output data contains the bits for deactivating the channel diagnostics (DD...) and for setting the VAUX1/VAUX2 monitoring, see "Basic" and "VAUX1/VAUX2" [▶ 188].

RX	Signal	RY	Signal
Digital channels		Deactivate diagnostics and Digit channels (DXP)	
RX0	DI0 (SIO)	RY0	DD0
RX1	DXP1	RY1	DXP1
RX2	DI2 (SIO)	RY2	DD2
RX3	DXP3	RY3	DXP3
RX4	DI4 (SIO)	RY4	DD4
RX5	DXP5	RY5	DXP5
RX6	DI6 (SIO)	RY6	DD6
RX7	DXP7	RY7	DXP7
RX8	DI8 (SIO)	RY8	DD8
RX9	-	RY9	-
RXA	DI10 (SIO)	RYA	DD10
RXB	-	RYB	-
RXC	DI12 (SIO)	RYC	DD12
RXD	-	RYD	-
RXE	DI14 (SIO)	RYE	DD14
RXF	-	RYF	-
RX10	DVS0	RY10	VAUX1 pin1 C0 (Ch0/1)
RX11	-	RY11	VAUX1 pin 1 C1 (Ch2/3)
RX12	DVS2	RY12	VAUX1 pin 1 C2 (Ch4/5)
RX13	-	RY13	VAUX1 pin 1 C3 (Ch6/7)
RX14	DVS4	RY14	VAUX1 pin 1 C4 (Ch8)
RX15	-	RY15	VAUX1 pin 1 C5 (Ch10)
RX16	DVS6	RY16	VAUX1 pin 1 C6 (Ch12)
RX17	-	RY17	VAUX1 pin 1 C7 (Ch14)
RX18	DVS8	RY18	-
RX19	-	RY19	-
RX1A	DVS10	RY1A	-
RX1B	-	RY1B	-
RX1C	DVS12	RY1C	VAUX2 pin2 C4 (Ch9)
RX1D	-	RY1D	VAUX2 pin2 C5 (Ch11)
RX1E	DVS14	RY1E	VAUX2 pin2 C6 (Ch13)
RX1F	-	RY1F	VAUX2 pin2 C7 (Ch15)

RX	Signal	RY	Signal
Module status (status word)			
RX20	DIAG		
RX21	ARGEE program active		
...	-		
RX27	V2		
RX28	-		
RX29	V1		
RX2A	Internal error		
...	-		
RX2E	FCE		
RX2F	-		

7.8.6 Word area

The data in the word area has different data sizes and content depending on the profile.

For a description of the process data, see "process input data" [▶ 186] and "process output data" [▶ 188].

1 occupied station (profile 1) [▶ 128]

RWr		Process input data	RWw		Process output data
Word (hex)	Bit		Word (hex)	Bit	
IO-Link input data			IO-Link output data		
RWr0...RWr1		IO-Link input data port 1	RWw0...RWw3		IO-Link output data port 1
RWr2...RWr3		IO-Link input data port 2	RWw4...RWw7		IO-Link output data port 2
RWr4...RWr5		IO-Link input data port 3	RWw8...RWwB		IO-Link output data port 3
RWr6...RWr7		IO-Link input data port 4	RWwC...RWwF		IO-Link output data port 4
RWr8...RWr9		IO-Link input data port 5	RWw10...RWw13		IO-Link output data port 5
RWrA...RWrB		IO-Link input data port 6	RWw14...RWw17		IO-Link output data port 6
RWrC...RWrD		IO-Link input data port 7	RWw18...RWw1B		IO-Link output data port 7
RWrE...RWrF		IO-Link input data port 8	RWw1C...RWw1F		IO-Link output data port 8
VAUX diagnostics					
RWr10	0x0	VERR V1 C0 Ch0Ch1			
	0x1	VERR V1 C1 Ch2Ch3			
	0x2	VERR V1 C2 Ch4Ch5			
	0x3	VERR V1 C3 Ch6Ch7			
	0x4	VERR V1 C4 Ch8			
	0x5	VERR V1 C5 Ch10			
	0x6	VERR V1 C6 Ch12			
	0x7	VERR V1 C7 Ch14			
	0x8... 0xB	-			
	0xC	VERR V2 C4 Ch9			
	0xD	VERR V2 C5 Ch11			
	0xE	VERR V2 C6 Ch13			
	0xF	VERR V2 C7 Ch15			
	DXP diagnostics				
RWr11	0x0	-			
	0x1	ERR DXP1			
	0x2	-			
	0x3	ERR DXP3			
	0x4	-			
	0x5	ERR DXP5			
	0x6	-			
	0x7	ERR DXP7			
	0x8... 0xF	-			

RWr		Process input data	RWw		Process output data
Word (hex)	Bit		Word (hex)	Bit	
Master and device diagnostics (IO-Link port 1...8)					
IO-Link port 1 (channel 0)					
RWr12	0x0	-			
	0x1	PPE			
	0x2	CFGERR			
	0x3	DSERR			
	0x4	HWERR			
	0x5	PDINV			
	0x6	EVT1			
	0x7	EVT2			
	0x8	PRMERR			
	0x9	OTEMP			
	0xA	LLVU			
	0xB	ULVE			
	0xC	VLOW			
	0xD	VHIGH			
	0xE	OLV			
	0xF	GENERR			
IO-Link port 2 (channel 2)					
RWr13	Assignment similar to IO-Link port 1				
IO-Link port 3 (channel 4)					
RWr14	Assignment similar to IO-Link port 1				
IO-Link port 4 (channel 6)					
RWr15	Assignment similar to IO-Link port 1				
IO-Link port 5 (channel 8)					
RWr16	Assignment similar to IO-Link port 1				
IO-Link port (channel 10)					
RWr17	Assignment similar to IO-Link port 1				
IO-Link port 7 (channel 12)					
RWr18	Assignment similar to IO-Link port 1				
IO-Link port 8 (channel 14)					
RWr19	Assignment similar to IO-Link port 1				

2 occupied station (profile 2) [▶ 128]

RWr		Process input data	RWw		Process output data
Word (hex)	Bit		Word (hex)	Bit	
IO-Link input data			IO-Link output data		
RWr0...RWr5		IO-Link input data port 1	RWw0...RWw7		IO-Link output data port 1
RWr6...RWrB		IO-Link input data port 2	RWw8...RWwF		IO-Link output data port 2
RWrC...RWr11		IO-Link input data port 3	RWw10...RWw17		IO-Link output data port 3
RWr12...RWr17		IO-Link input data port 4	RWw18...RWw1F		IO-Link output data port 4
RWr18...RWr1D		IO-Link input data port 5	RWw20...RWw27		IO-Link output data port 5
RWr1E...RWr23		IO-Link input data port 6	RWw28...RWw2F		IO-Link output data port 6
RWr24...RWr29		IO-Link input data port 7	RWw30...RWw37		IO-Link output data port 7
RWr2A...RWr2F		IO-Link input data port 8	RWw38...RWw3F		IO-Link output data port 8
VAUX diagnostics					
RWr30	0	VERR V1 C0 Ch0Ch1			
	1	VERR V1 C1 Ch2Ch3			
	2	VERR V1 C2 Ch4Ch5			
	3	VERR V1 C3 Ch6Ch7			
	4	VERR V1 C4 Ch8			
	5	VERR V1 C5 Ch10			
	6	VERR V1 C6 Ch12			
	7	VERR V1 C7 Ch14			
	8...	-			
	11				
	12	VERR V2 C4 Ch9			
	13	VERR V2 C5 Ch11			
	14	VERR V2 C6 Ch13			
	15	VERR V2 C7 Ch15			
	DXP diagnostics				
RWr31	0	-			
	1	ERR DXP1			
	2	-			
	3	ERR DXP3			
	4	-			
	5	ERR DXP5			
	6	-			
	7	ERR DXP7			
	8...	-			
	15				

RWr		Process input data	RWw		Process output data
Word (hex)	Bit		Word (hex)	Bit	
Master and device diagnostics (IO-Link port 1...8)					
IO-Link port 1 (channel 0)					
RWr32	0	-			
	1	PPE			
	2	CFGERR			
	3	DSERR			
	4	HWERR			
	5	PDINV			
	6	EVT1			
	7	EVT2			
	8	PRMERR			
	9	OTEMP			
	10	LLVU			
	11	ULVE			
	12	VLOW			
	13	VLOW			
	14	OLV			
15	GENERR				
IO-Link port 2 (channel 2)					
RWr33	Assignment similar to IO-Link port 1				
IO-Link port 3 (channel 4)					
RWr34	Assignment similar to IO-Link port 1				
IO-Link port 4 (channel 6)					
RWr35	Assignment similar to IO-Link port 1				
IO-Link port 5 (channel 8)					
RWr36	Assignment similar to IO-Link port 1				
IO-Link port 6 (channel 10)					
RWr37	Assignment similar to IO-Link port 1				
IO-Link port 7 (channel 12)					
RWr38	Assignment similar to IO-Link port 1				
IO-Link port (channel 14)					
RWr39	Assignment similar to IO-Link port 1				

3 occupied station (profile 3) [▶ 128]

RWr		Process input data	RWw		Process output data
Word (hex)	Bit		Word (hex)	Bit	
IO-Link input data			IO-Link output data		
RWr0...RWr5		IO-Link input data port 1	RWw0...RWwB		IO-Link output data port 1
RWr6...RWrB		IO-Link input data port 2	RWwC...RWw17		IO-Link output data port 2
RWrC...RWr11		IO-Link input data port 3	RWw18...RWw23		IO-Link output data port 3
RWr12...RWr17		IO-Link input data port 4	RWw24...RWw2F		IO-Link output data port 4
RWr18...RWr1D		IO-Link input data port 5	RWw30...RWw3B		IO-Link output data port 5
RWr1E...RWr23		IO-Link input data port 6	RWw3C...RWw47		IO-Link output data port 6
RWr24...RWr29		IO-Link input data port 7	RWw48...RWw53		IO-Link output data port 7
RWr2A...RWr2F		IO-Link input data port 8	RWw54...RWw5F		IO-Link output data port 8
VAUX diagnostics					
RWr30	0	VERR V1 C0 Ch0Ch1			
	1	VERR V1 C1 Ch2Ch3			
	2	VERR V1 C2 Ch4Ch5			
	3	VERR V1 C3 Ch6Ch7			
	4	VERR V1 C4 Ch8			
	5	VERR V1 C5 Ch10			
	6	VERR V1 C6 Ch12			
	7	VERR V1 C7 Ch14			
	8...	-			
	11				
	12	VERR V2 C4 Ch9			
	13	VERR V2 C5 Ch11			
	14	VERR V2 C6 Ch13			
	15	VERR V2 C7 Ch15			
	DXP diagnostics				
RWr31	0	-			
	1	ERR DXP1			
	2	-			
	3	ERR DXP3			
	4	-			
	5	ERR DXP5			
	6	-			
	7	ERR DXP7			
	8...	-			
	15				

RWr		Process input data	RWw		Process output data
Word (hex)	Bit		Word (hex)	Bit	
Master and device diagnostics (IO-Link port 1...8)					
IO-Link port 1 (channel 0)					
RWr32	0	-			
	1	PPE			
	2	CFGERR			
	3	DSERR			
	4	HWERR			
	5	PDINV			
	6	EVT1			
	7	EVT2			
	8	PRMERR			
	9	OTEMP			
	10	LLVU			
	11	ULVE			
	12	VLOW			
	13	VLOW			
	14	OLV			
15	GENERR				
IO-Link port 2 (channel 2)					
RWr33	Assignment similar to IO-Link port 1				
IO-Link port 3 (channel 4)					
RWr34	Assignment similar to IO-Link port 1				
IO-Link port 4 (channel 6)					
RWr35	Assignment similar to IO-Link port 1				
IO-Link port 5 (channel 8)					
RWr36	Assignment similar to IO-Link port 1				
IO-Link port 6 (channel 10)					
RWr37	Assignment similar to IO-Link port 1				
IO-Link port 7 (channel 12)					
RWr38	Assignment similar to IO-Link port 1				
IO-Link port 8 (channel 14)					
RWr39	Assignment similar to IO-Link port 1				

RWr		Process input data	RWw		Process output data			
Word (hex)	Bit		Word (hex)	Bit				
IO-Link events								
RWr3A	0...7	Qualifier 1st event						
	8...15	Port 1st event						
RWr3B	0...15	Event code 1st event						
RWr3C	0...7	Qualifier 2nd event						
	8...15	Port 2nd event						
RWr3D	0...15	Event code 2nd event						
...								
RWr58	0...7	Qualifier 16th event						
	8...15	Port 16th event						
RWr59	0...15	Event code 16th event						

4 occupied station (profile 4) [▶ 128]

RWr		Process input data	RWw		Process output data
Word (hex)	Bit		Word (hex)	Bit	
IO-Link input data			IO-Link output data		
RWr0...RWrF		IO-Link input data port 1	RWw0...RWwF		IO-Link output data port 1
RWr1...RWr1F		IO-Link input data port 2	RWw10...RWw1F		IO-Link output data port 2
RWr20...RWr2F		IO-Link input data port 3	RWw20...RWw2F		IO-Link output data port 3
RWr30...RWr3F		IO-Link input data port 4	RWw30...RWw3F		IO-Link output data port 4
RWr40...RWr4F		IO-Link input data port 5	RWw40...RWw4F		IO-Link output data port 5
RWr50...RWr5F		IO-Link input data port 6	RWw50...RWw5F		IO-Link output data port 6
RWr60...RWr6F		IO-Link input data port 7	RWw60...RWw6F		IO-Link output data port 7
RWr70...RWr7F		IO-Link input data port 8	RWw70...RWw7F		IO-Link output data port 8

7.8.7 Parameter mapping

The chapter "Parameterizing and configuring" [▶ 170] contains a detailed parameter description.

Parameter ID	Offset	Parameter name	Channel	Value	Meaning		
B000	0.0	Manual output reset after overcurrent Ch1	1	0	No		
				1	Yes		
	0.3	Manual output reset after overcurrent Ch3	3	0	No		
				1	Yes		
	0.5	Manual output reset after overcurrent Ch5	5	0	No		
				1	Yes		
	0.7	Manual output reset after overcurrent Ch7	7	0	No		
				1	Yes		
	1.0	Activate output Ch1	1	0	No		
				1	Yes		
	1.3	Activate output Ch3	3	0	No		
				1	Yes		
	1.5	Activate output Ch5	5	0	No		
				1	Yes		
1.7	Activate output Ch7	7	0	No			
			1	Yes			
B001	0.0	Operation mode	IOL1	0	IO-Link without validation		
				1	IO-Link with family compatible device		
				2	IO-Link with compatible device		
				3	IO-Link with identical device		
				4	DI (with parameter access)		
				8	DI		
				0.4	Data storage mode	0	Activated
						1	Overwrite
	2	Read in					
	3	Deactivated, clear					
	0.6	Activate Quick Start-Up		0	Inactive		
				1	Active		
	0.7	Device parameterization via GSD (GSD)		0	Inactive		
				1	Active		
	0.8	Cycle time		0	Automatic		
				16... 191	1.6...132.8 ms		
				255	Automatic, compatible		
	1.0	Revision		0	Automatic		
				1	V1.0		
	1.1	Process input data invalid (PDIN invalid)		0	Diagnostics generated		
1				No diagnostics generated			

Parameter ID	Offset	Parameter name	Channel	Value	Meaning
B001	1.2	Deactivate diagnostics	IOL1	0	No
				1	Notifications
				2	Notifications and warnings
				3	Yes
	1.4	Process input data mapping (Mapping PDIN)		0	Direct
				1	Swap 16 bit
				2	Swap 32 bit
				3	Swap all
	1.6	Process output data mapping (Mapping PDOOUT)		0	Direct
				1	Swap 16 bit
				2	Swap 32 bit
				3	Swap all
	4.0	Vendor ID		0...65535	
5.0	Device ID	0...16777215			
B002			IOL2	Assignment similar to B001 for IOL1	
...			...		
B008			IOL8		
B009	0.0	VAUX1 Pin1 C0 (Ch0/1)	0/1	0	24 VDC
				1	switchable
				2	Off
	0.8	VAUX1 Pin1 C1 (Ch2/3)	2/3	Assignment acc. to offset 0.0 for C0	
	1.0	VAUX1 Pin1 C2 (Ch4/5)	4/5		
	1.8	VAUX1 Pin1 C3 (Ch6/7)	6/7		
	2.0	VAUX1 pin 1 C4 (Ch8/9)	8/9		
	2.8	VAUX1 Pin1 C5 (Ch10/11)	10/11		
	3.0	VAUX1 pin 1 C6 (Ch12/13)	12/13		
	3.8	VAUX1 pin 1 C7 (Ch14/15)	14/15		
	6.0	VAUX2 Pin2 1 C4 (Ch8/9)	8/9		
	6.8	VAUX2 Pin2 C5 (Ch10/11)	10/11		
	7.0	VAUX2 Pin2 1 C6 (Ch12/13)	12/13		
7.8	VAUX2 Pin2 1 C7 (Ch14/15)	14/15			

7.8.8 Acyclic communication via SLMP – supported functions

The devices support acyclical access via SLMP command Device Read (0x0401) and Device Write (0x1401).

Supported Device Codes

Device Code	Description
0x0011	Device information (vendor ID, device code, device name, etc.)
0x00AC	Acyclic communication
0x00D8	Input data
0x00D9	Output data
0x00DD	Diagnostic data

Supported End Codes

End Code	Description
0x0000	Command successfully executed
0xC059	Command/subcommand: not supported command or subcommand
0xC05C	Wrong data: data content does not fit to the command data content does not fit to the command
0xC061	Data length: data length does not fit to the command

Read device information (Device Code 0x0011)

Address (Add)	Content	Access type	Data length in word (Len)	Description
0x0001	Vendor code	ro	1	Vendor ID Turck: 0x3355
0x0002	Model code	ro	2	ID of the device
0x0003	Model name	ro	2	Device name
0x0004	FW version	ro	2	Firmware version of the device
0x0005	Stack version	ro	2	Version of the CC-Link component

Acyclic I/O communication (Device Code 0x00AC)

Address (Add)	Read access	Write access	Data length in word (Len)	Content	Description
0xACAC	Open Connection		1	0xAD00... 0xADFF, 0x0000	A read access to this address opens an acyclic connection or returns an error. A valid connection handle is 0xAD00...0xADFF, or 0 in case of failure.
0xACAC		Close Connection	1	0xAD00... 0xADFF, 0xFFFF	Write access to this address closes an acyclic connection. Writing a previously opened connection address (0xAD00...0xADFF) closes this connection. If the value -1 (0xFFFF) is written, all acyclic connections opened for CC-Link are closed.
0xAD00 ... 0xADFF			1...240	Acyclic data	

Example access:

1. **Open Connection:**

Device Read (0x0401)
Device Code = 0xAC
Add = 0xACAC
Len = 1

Result: 0xAD00 = Connection address: must be used for the following connection accesses, like read, write and close.

2. **Read Connection:**

Device Read (0x0401)
Device Code = 0xAC
Add = 0xAD00
Len = 1

Result: n words of received frame. The requested length is the maximum buffer size. If the available acyclic data does not fit in the buffer, the exceeding data is truncated.

3. **Write Connection:**

Device Read (0x1401)
Device Code = 0xAC
Add = 0xAD00
Len = 1

Result: n words of data to be sent.

4. **Close Connection:**

Device Write (0x1401)
Device Code = 0xAC
Add=0xACAC,
Len=1

Data: 0xADxx (address of the previously used Open Connection)

Read input data (Device Code 0x00D8)

Address (Add)	Access type	Data length in word (Len)	Description
0x0000	ro	1...n	Access to all input data of the device regardless of profiles and restrictions due to the number of occupied stations, order: <ol style="list-style-type: none"> 1. Data from RWr area 2. Data from RX area
0x0001 ... 0x00...	ro	1...n	Accesses the input data of one (sub)module. Data is structured in the native order of that (sub)module.

Write output data (Device Code 0x00D9)

Address (Add)	Access type	Data length in word (Len)	Description
0x0000	rw	1...n	Access to all output data of the device regardless of profiles and restrictions due to the number of occupied stations, order: <ol style="list-style-type: none"> 1. Data from RWw area 2. Data from RY area
0x0001 ... 0x00...	rw	1...n	Accesses the output data of one (sub)module. Data is structured in the native order of that (sub)module.

Read Diagnostic data data (Device Code 0x00DD)

Address (Add)	Access type	Data length in word (Len)	Description
0x0000	ro	1...n	Access to all diagnostic data of the device regardless of profiles and restrictions due to the number of occupied stations
0x0001 ... 0x00...	ro	1...n	Accesses the diagnostic data data of one (sub)module. Data is structured in the native order of that (sub)module.

7.9 Connecting devices to a CC-Link IE Field Basic client with GX Works3

Naming convention

Turck uses the terms "client" and "server". The following description uses the terms "Master Station" (client) and "Slave Station" (server) only because of the naming in Melsoft GX Works.

Used hardware

The following hardware components are used in this example:

- Mitsubishi MELSEC iQ-R controller
- Mitsubishi CPU 04ENCPU with local CC-Link IOs
- TBEN modules (as example)
 - TBEN-LL-8DIP-8DOP (IP address: 192.168.3.10)
 - TBEN-S2-4IOL (IP address: 192.168.3.12)

Used software

The following software tools are used in this example:

- Melsoft GX Works3

Prerequisites

- The GX Works3 software is open and a new project has been created.
- The controller including CPU and local IOs is configured in GX Works3.

7.9.1 Register the CSP+ files in GXWorks3

- ▶ Select and register CSP+ files via **Tools** → **Profile Management** → **Register**.
Note: CSP+ files can only be registered in GX Works3 if no project is open.

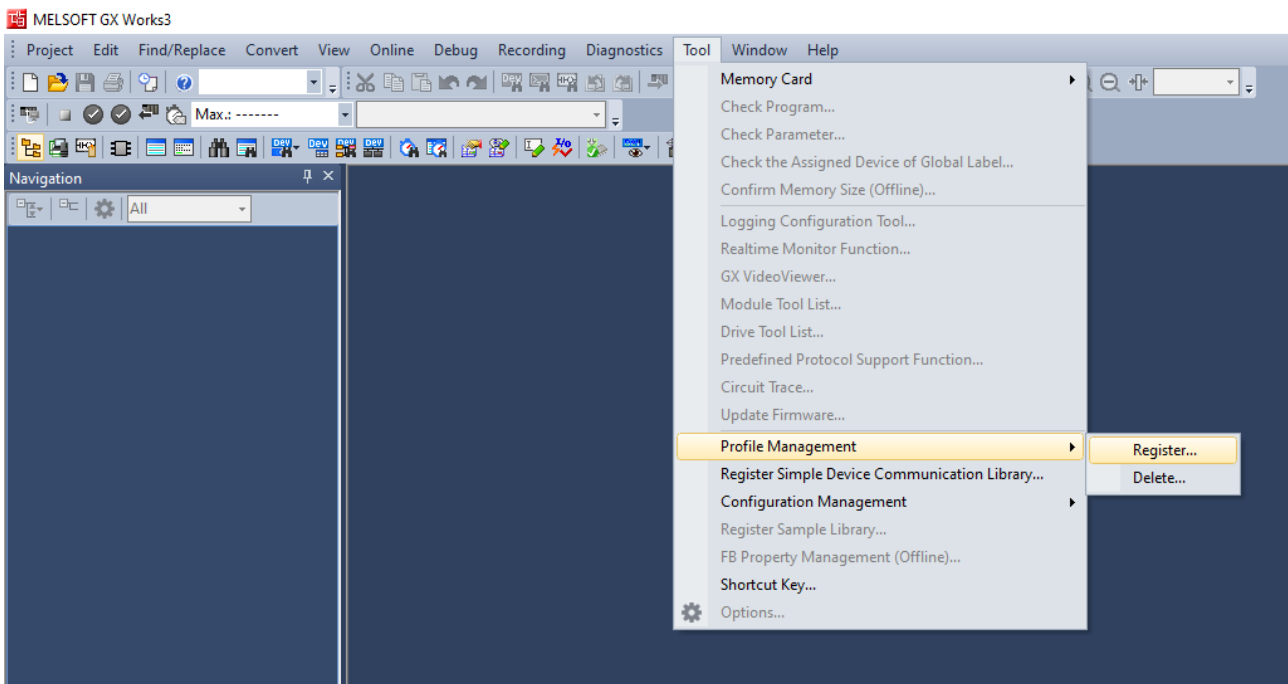

Fig. 72: Profile Management, Register Profile

7.9.2 Configuring the network settings

The network settings are configured at the CPU used under **Parameter** → **used CPU** (here: R04ENCPU) → **Module Parameters**.

Setting the IP address of the CPU

- ▶ Set the IP address of the CPU under **Own Node Settings** → **IP Address**.

Activate CC-Link Field Basic

The CC-Link IEF Basic protocol must be activated in the CPU.

- ▶ Under **CC-Link IEF Basic Settings**, set the option **To Use or Not to Use CC-Link IEF Basic Setting** to **Use** in order to activate

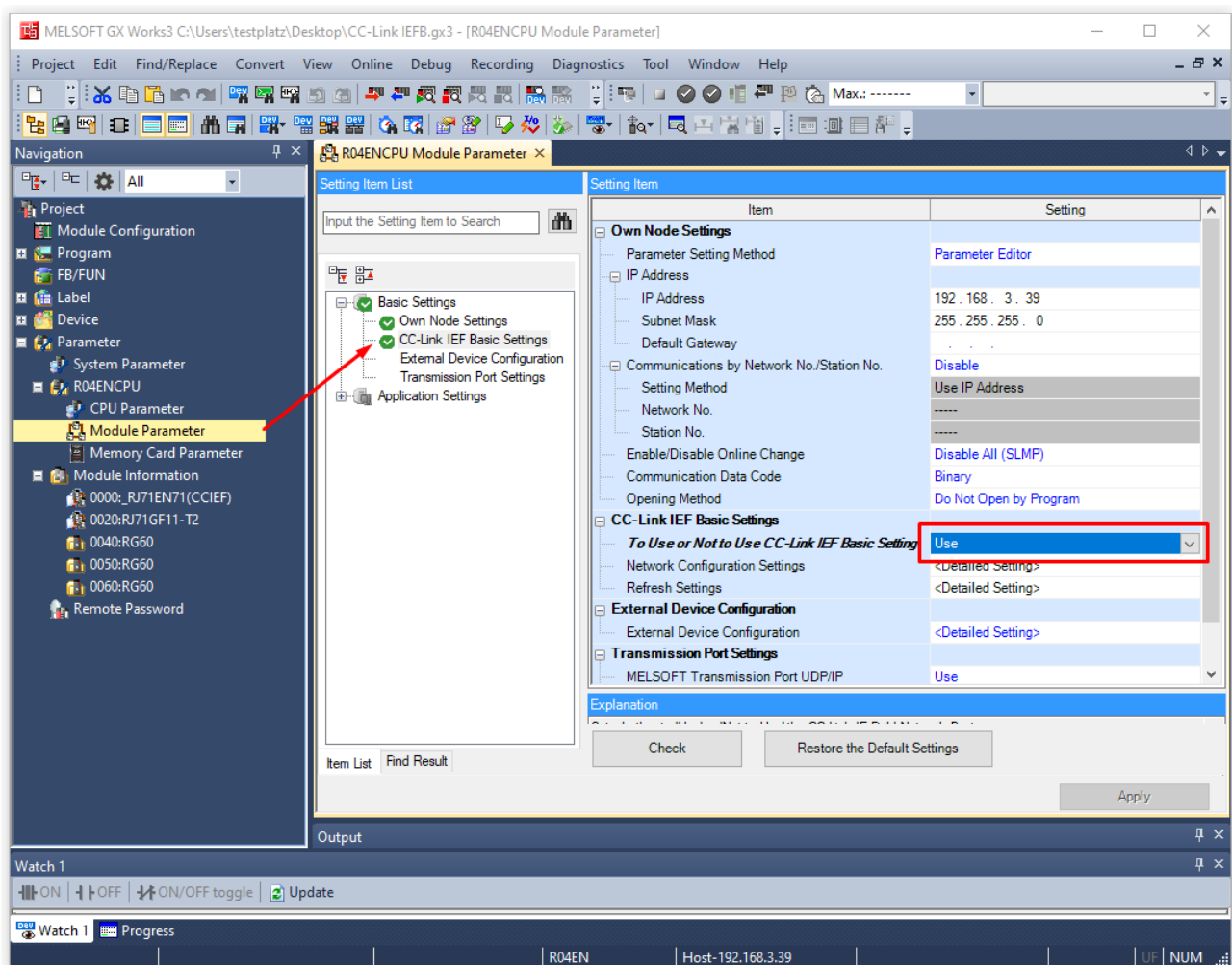

Fig. 73: GX Works3: Activate CC-Link IEF Basic on CPU

7.9.3 Configuring the CC-Link IE Field Basic network

Scanning the network

- ▶ Under **Module Parameters** → **CC-Link IEF Basic Settings** open the function **Network Configuration Settings**.

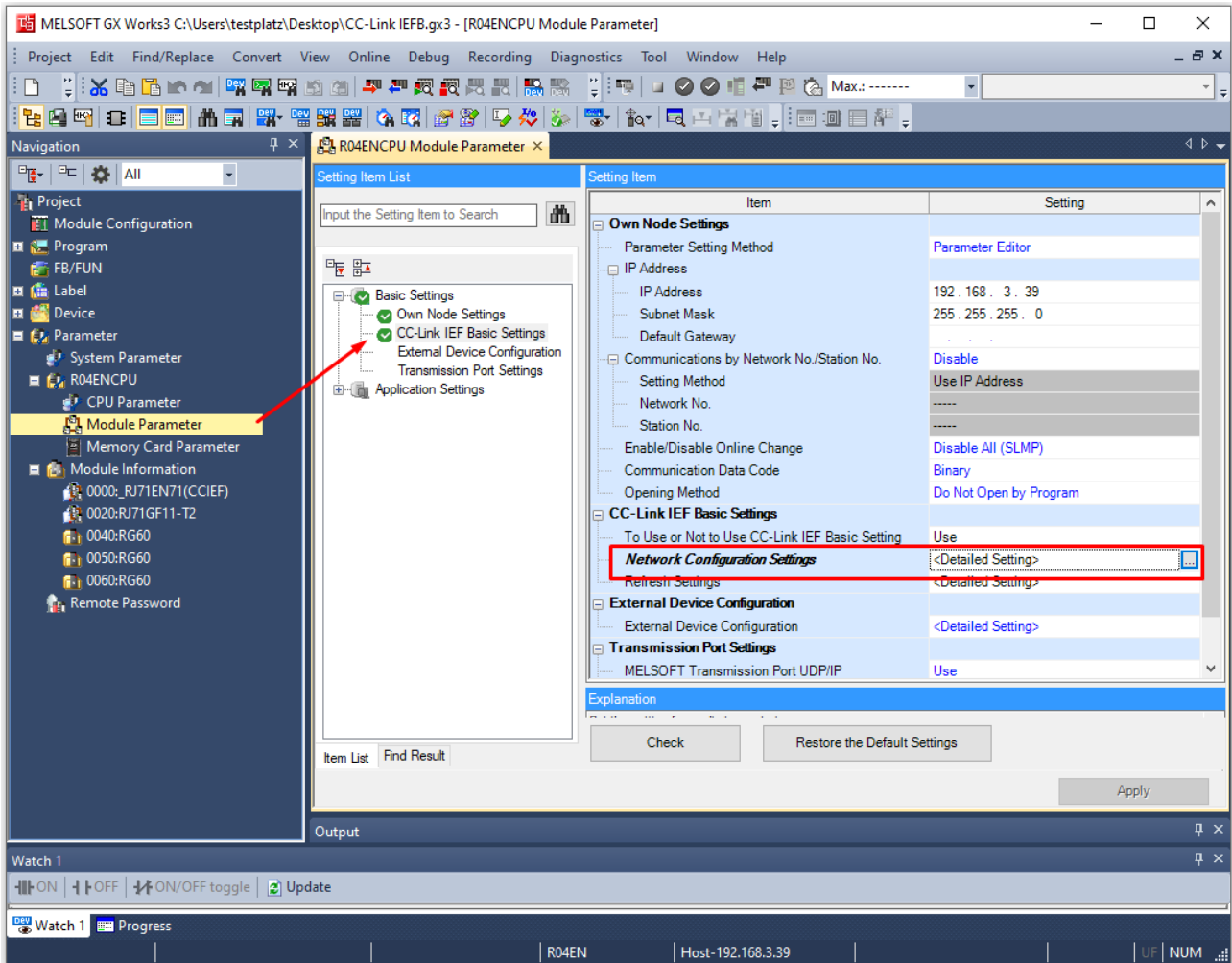

Fig. 74: GX Works3: Network Configuration Settings

- ▶ Scan the CC-Link IEF Basic network under **CC-Link IEF Basic Configuration** via **Detect Now**.

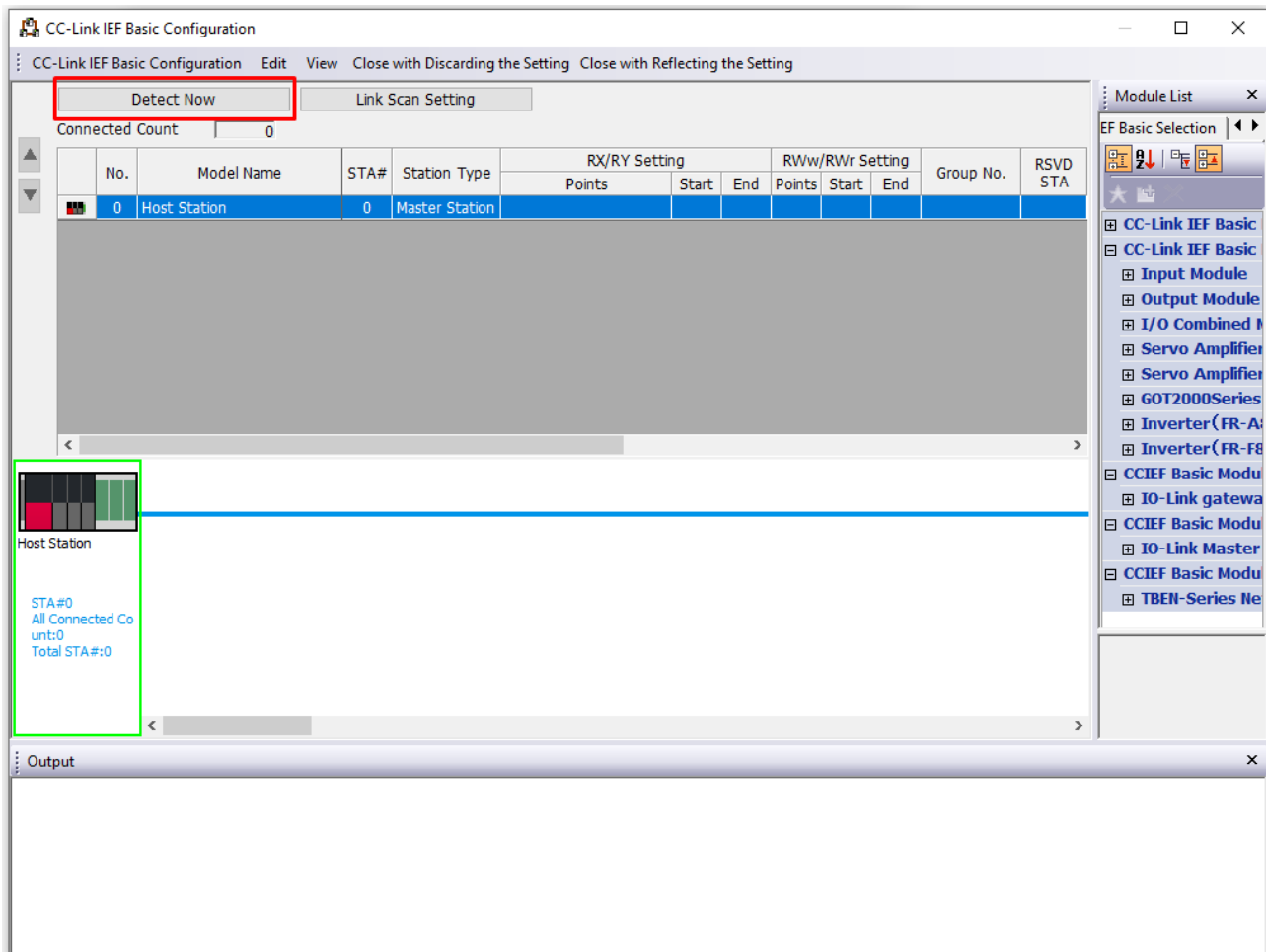

Fig. 75: GX Works3: scanning the CC-Link IEF Basic network

⇒ All CC-Link devices found in the Ethernet network are displayed in the order in which they are integrated in the network.

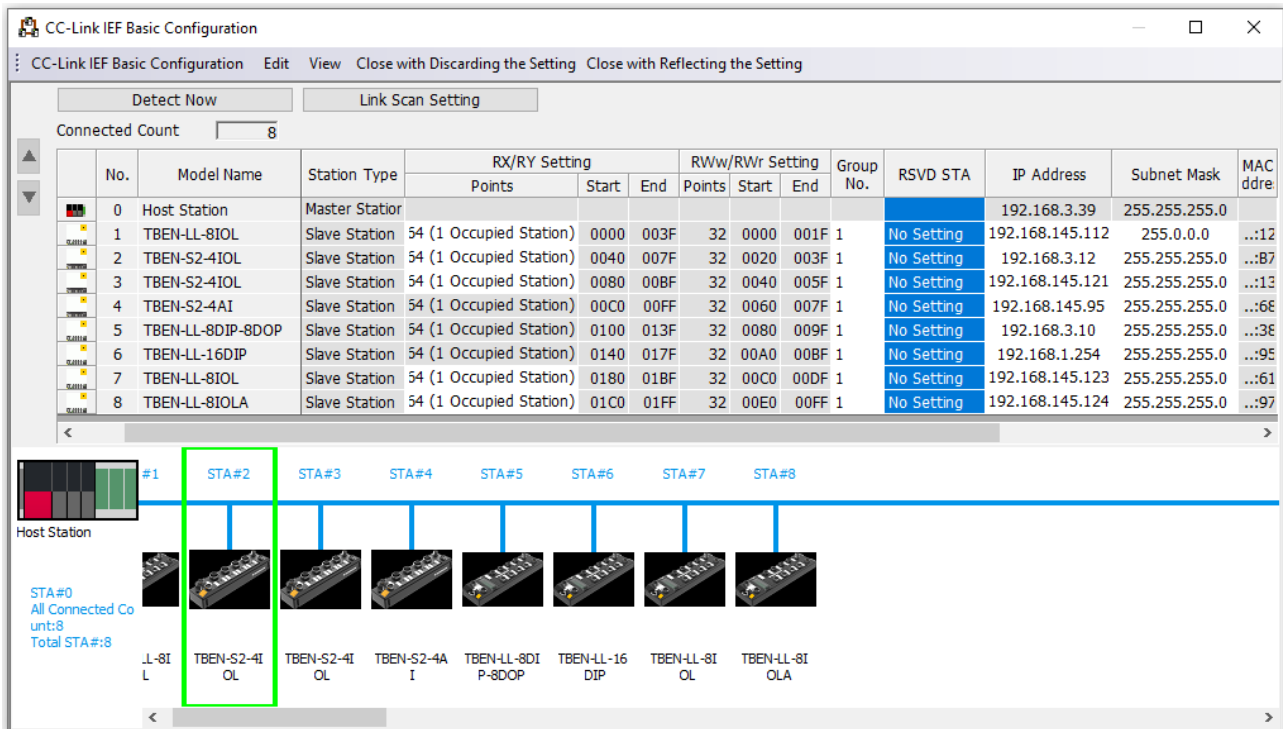

Fig. 76: GX Works3: Devices in the CC-Link IEF Basic network

Devices that do not match the IP address range of the controller cannot be added to the project.

- ▶ Delete the devices with an IP address outside the IP address range of the control unit by right-clicking on the device → **Delete** from the list of network nodes or change the devices' IP address in the **IP address column**.
- ▶ For devices that can be integrated with different process data variables (profiles) (here: TBEN-S2-4IOL): select the requested profile under **Station Type**.

Parameterizing CC-Link nodes

- ▶ Right-click on the device to be parameterized and select the device parameters via **Online** → **Parameter Processing of Slave Station**.

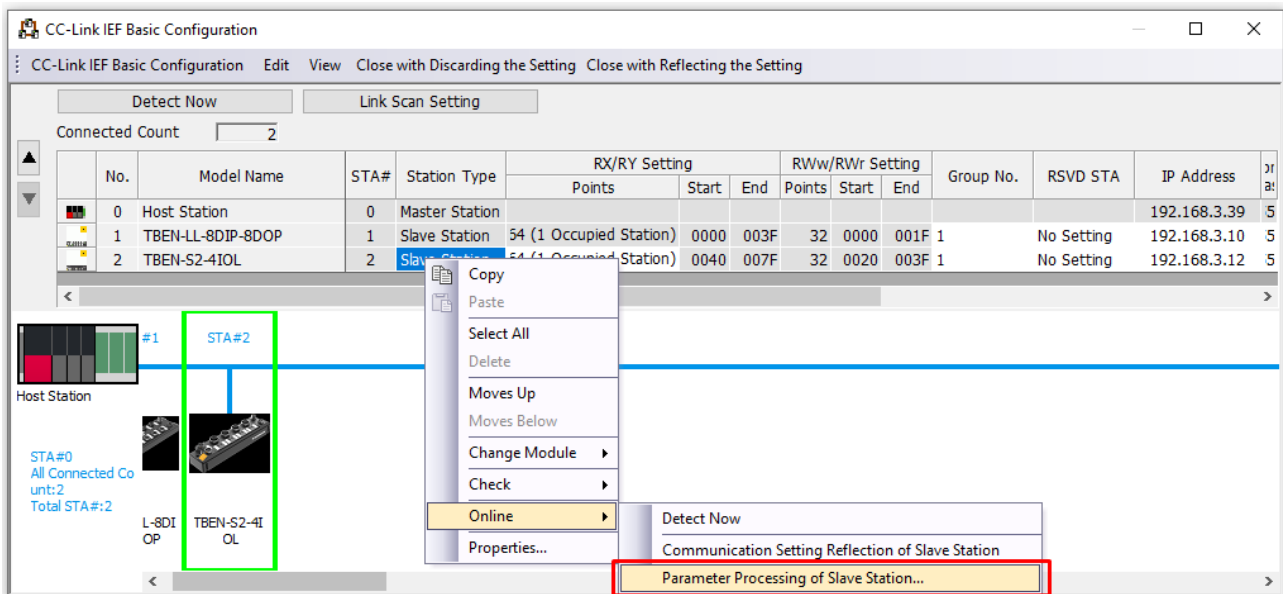

Fig. 77: GX Works3: Opening parameterization

- ▶ Activate the writing of parameters via **Method selection** → **Parameter write**.



NOTE

All parameters for one slot (in the example below: Slot 1) must be set. It is not possible to set individual parameters for a slot.

- ▶ Set the parameters and store the settings via **Execute**.

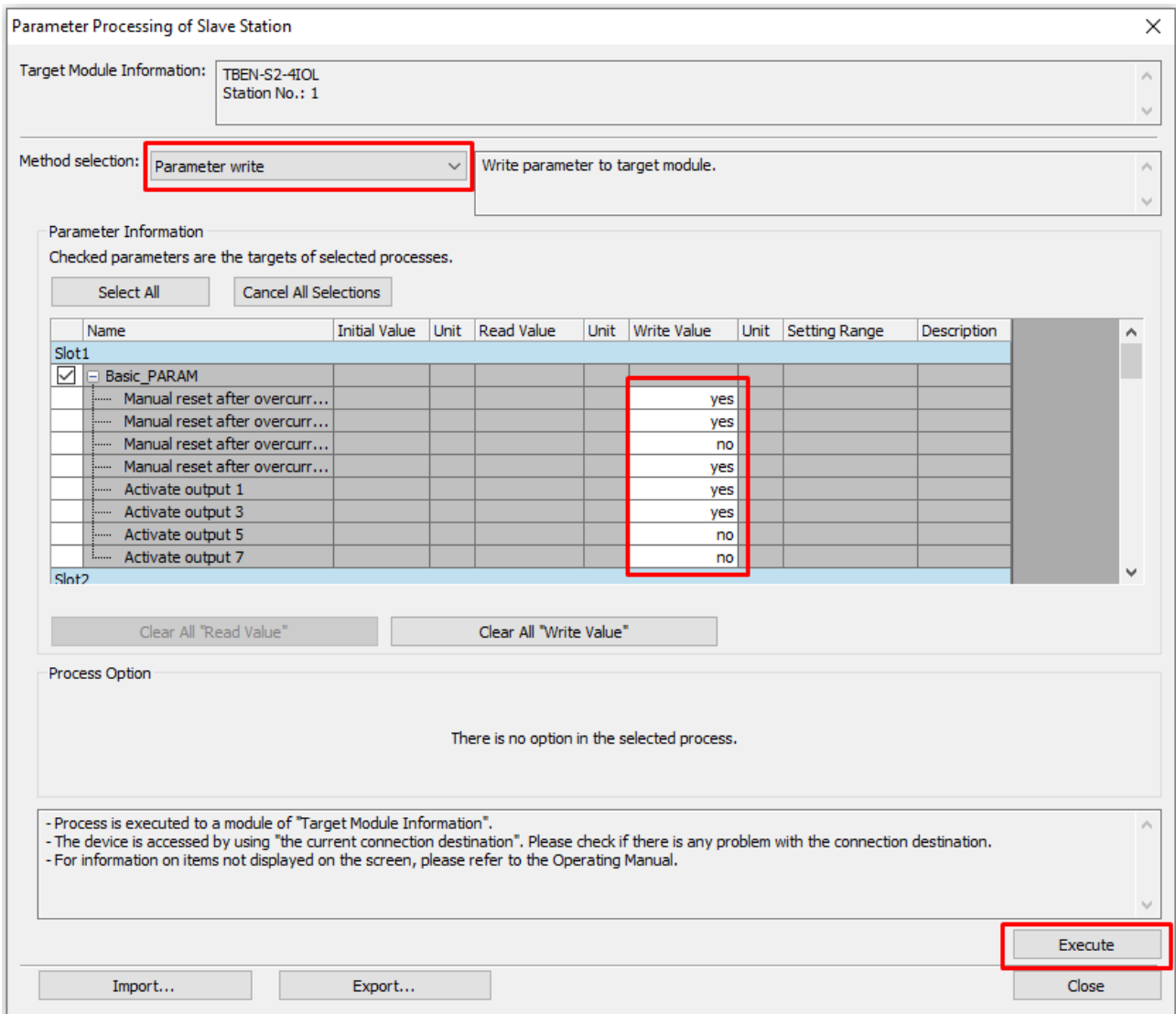

Fig. 78: GX Works3: Parameterizing the device

- ▶ Optional: Export the parameter settings under **Method selection** → **Parameter read** as CSV file and re-import the file under **Method selection** → **Parameter write** in order to fill the column **Write Values** with the actual parameter settings and then to be able to change single parameters.
- ▶ Close the window **CC-Link IEF Basic Configuration** via **Close with Reflecting the Setting** and store the network structure.

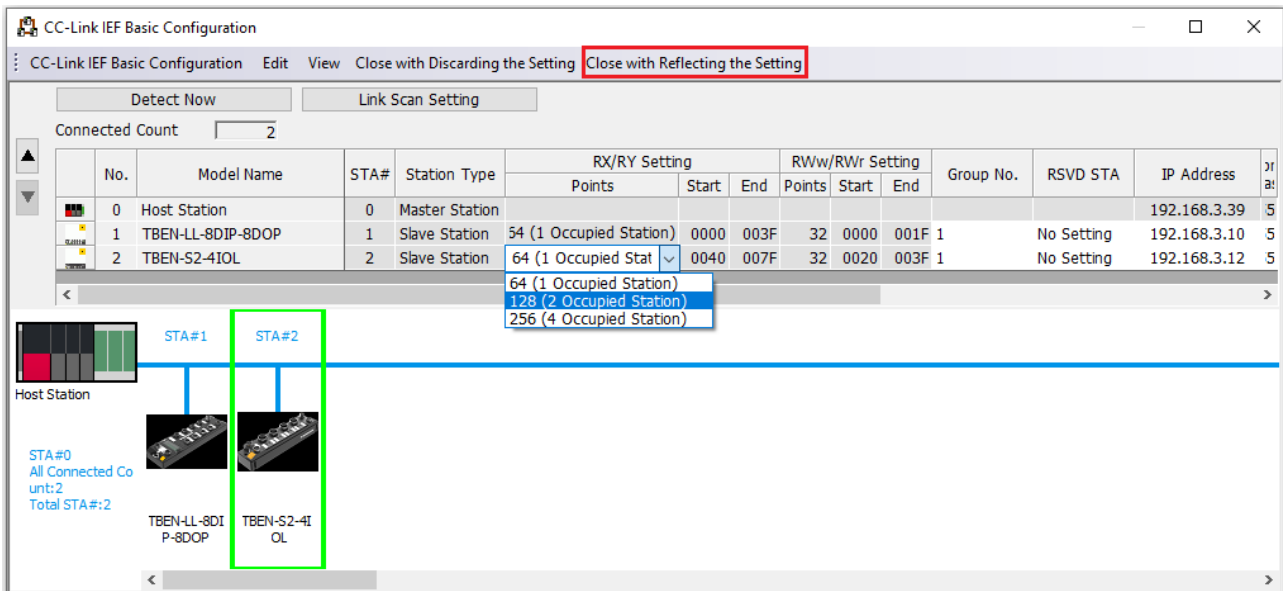

Fig. 79: GX Works3: Storing the network structure

- ▶ Accept the changes in the network structure under **Module Parameters** with **Apply**.

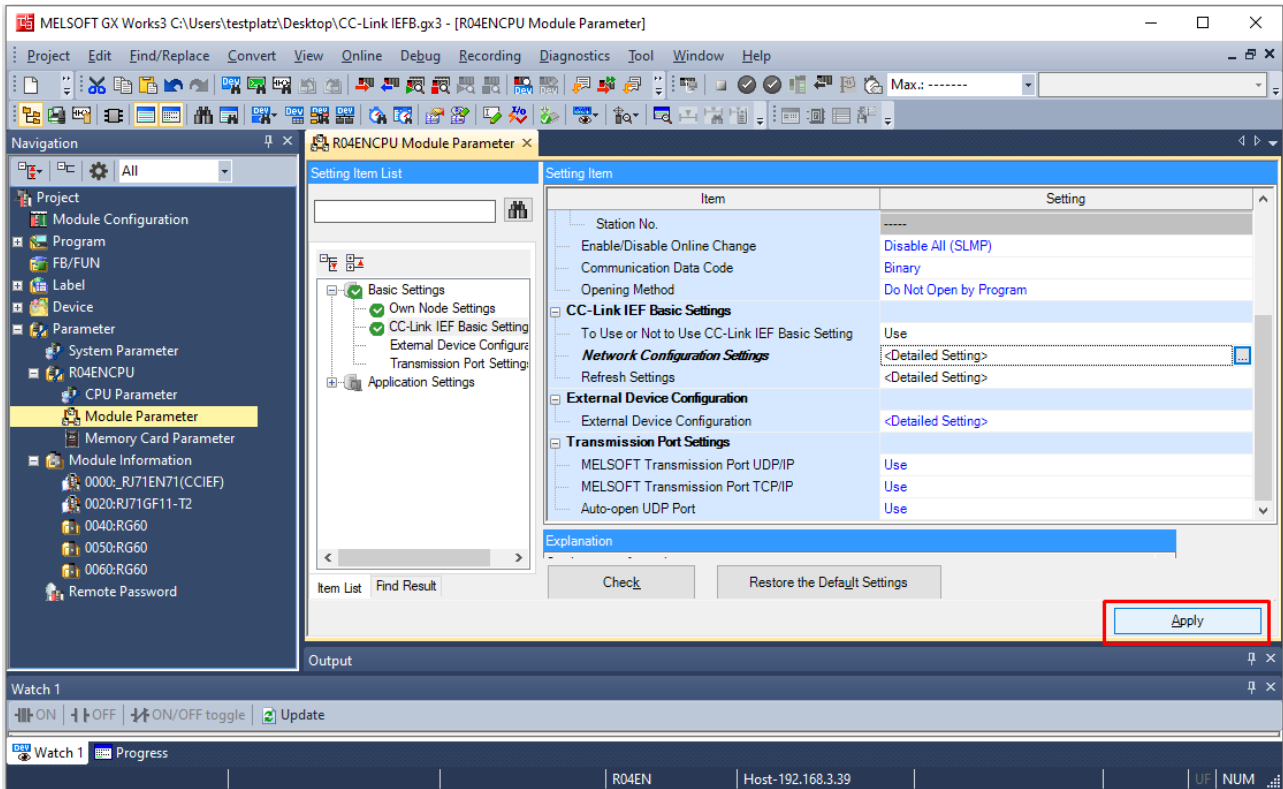

Fig. 80: GX Works3: Module Parameters, accept changes

7.9.4 Defining the process data mapping for CC-Link devices in the network

The start addresses of the process data for the devices that follow the **Master Station (Client)** (controller + local IOs) in the network are defined under **Module Parameters** → **CC-Link IEF Basic Settings** using the **Refresh Settings** function.

- ▶ Open the **Refresh Settings** function under **Module Parameters** → **CC-Link IEF Basic Settings**.
- ▶ Define the start addresses for the process data of the CC-Link devices in **CPU side**. **Check** can be used to verify whether the addresses are valid or overlap with the memory area occupied by the control unit.
- ▶ Accept the mapping settings with **Apply**.

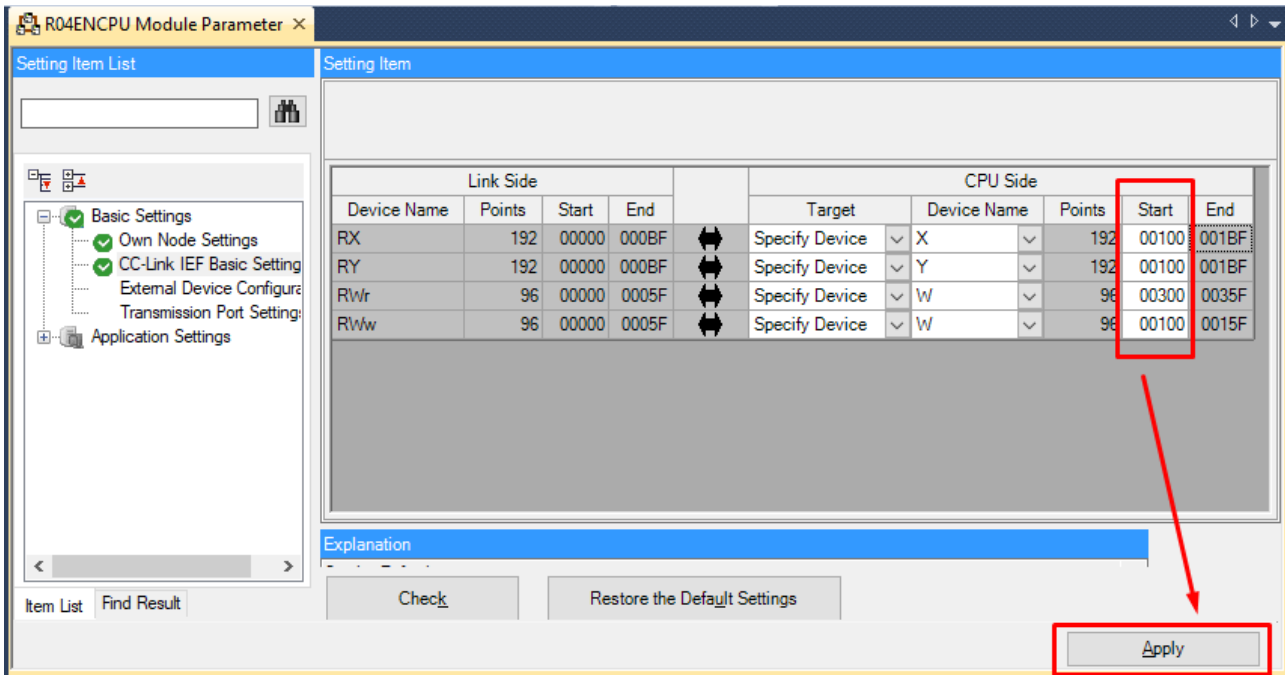

Fig. 81: GX Works3: Process data mapping in Refresh Settings



NOTE

Adjusting the mapping may require a voltage reset of the control unit.

7.9.5 Going online with the PLC

- ▶ Write the configuration to the PLC via Online → Write to PLC.

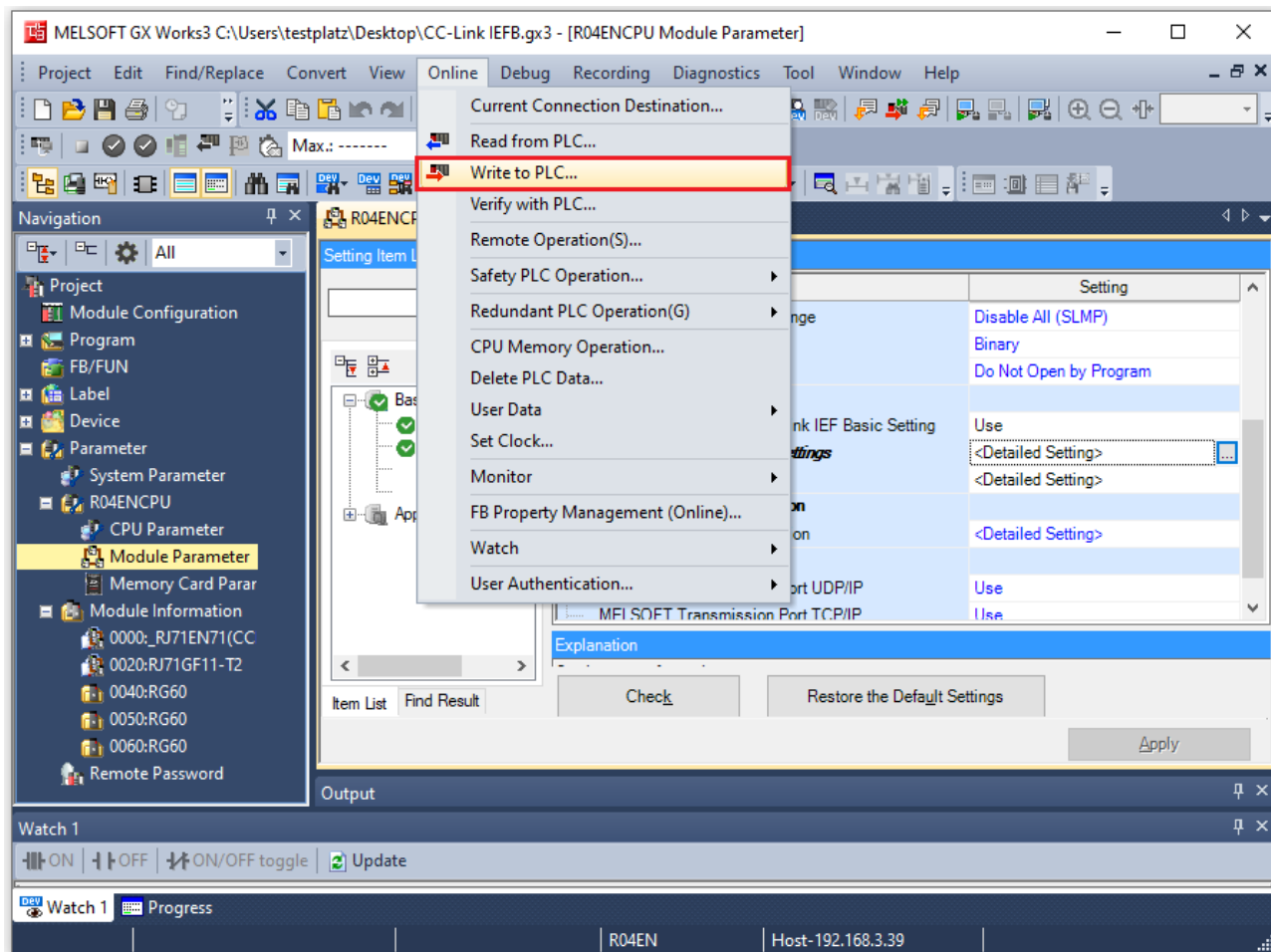

Fig. 82: GX Works3: Writing the configuration to the PLC

- ▶ If necessary, define which data have to be written and click **Execute**.

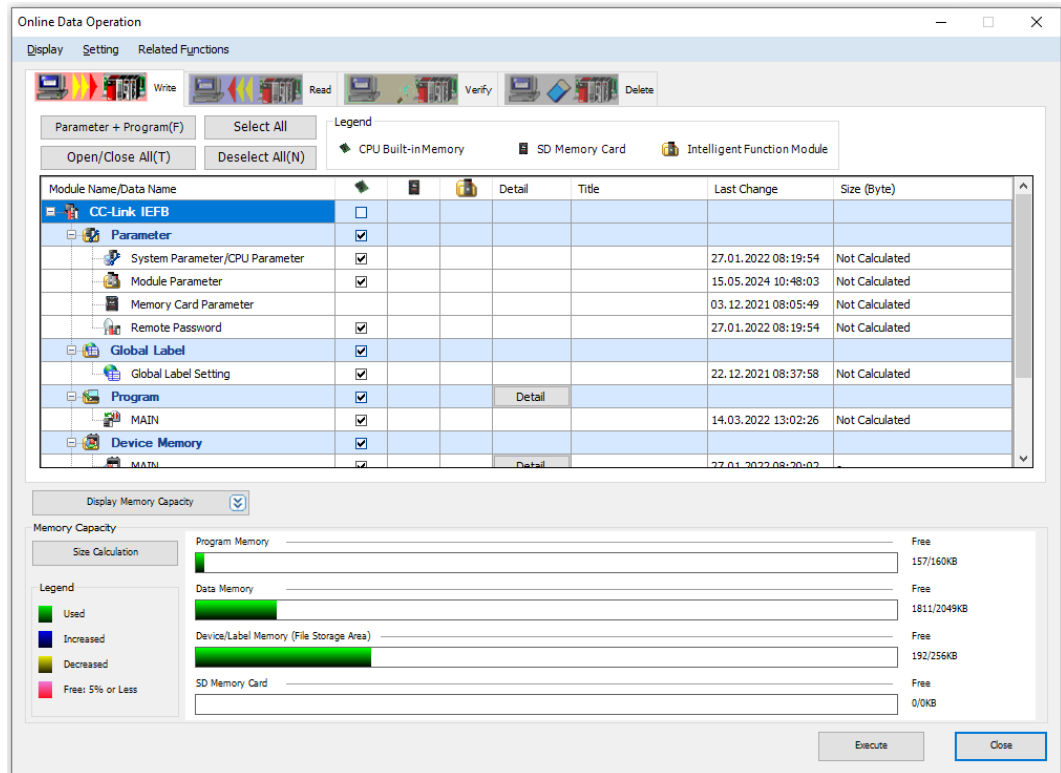

Fig. 83: GX Works3: Selecting data to be written

7.9.6 Reading process data

The monitoring of process data is done in the **Device/Buffer Memory Batch Monitor**.

- ▶ Open the monitoring via **Online** → **Monitor** → **Device/Buffer Memory Batch Monitor**.

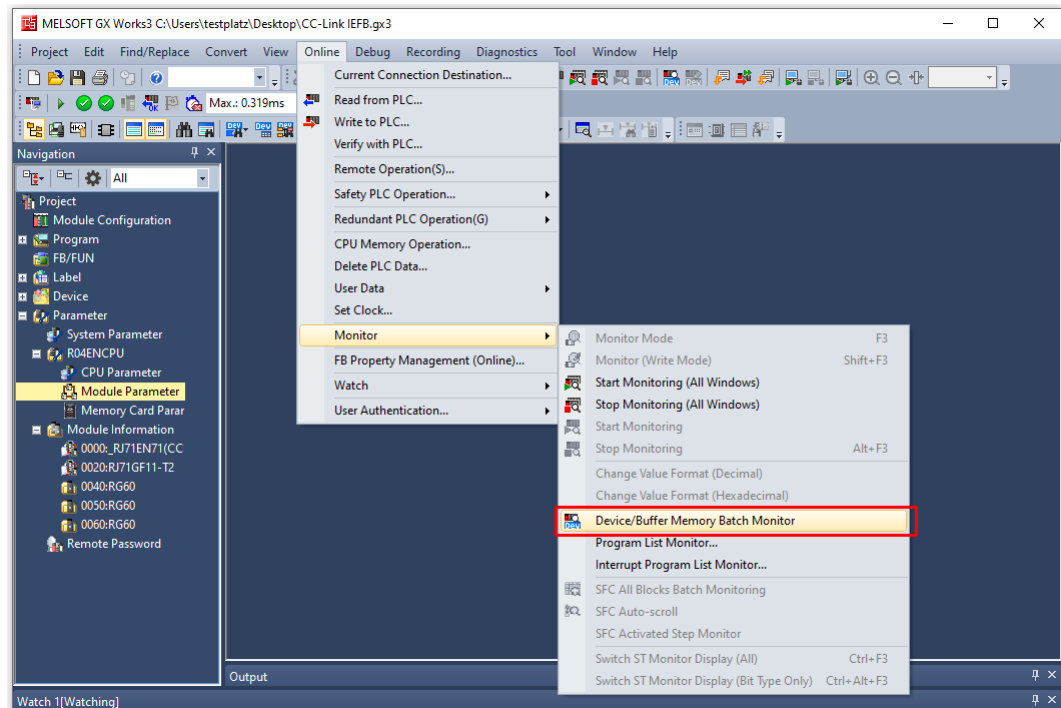

Fig. 84: GX Works3: Starting the monitoring of process data

- ▶ Enter the address of the process data to be read under **Device Name**. According to the defined process data mapping [▶ 153] X100 is selected as start address.

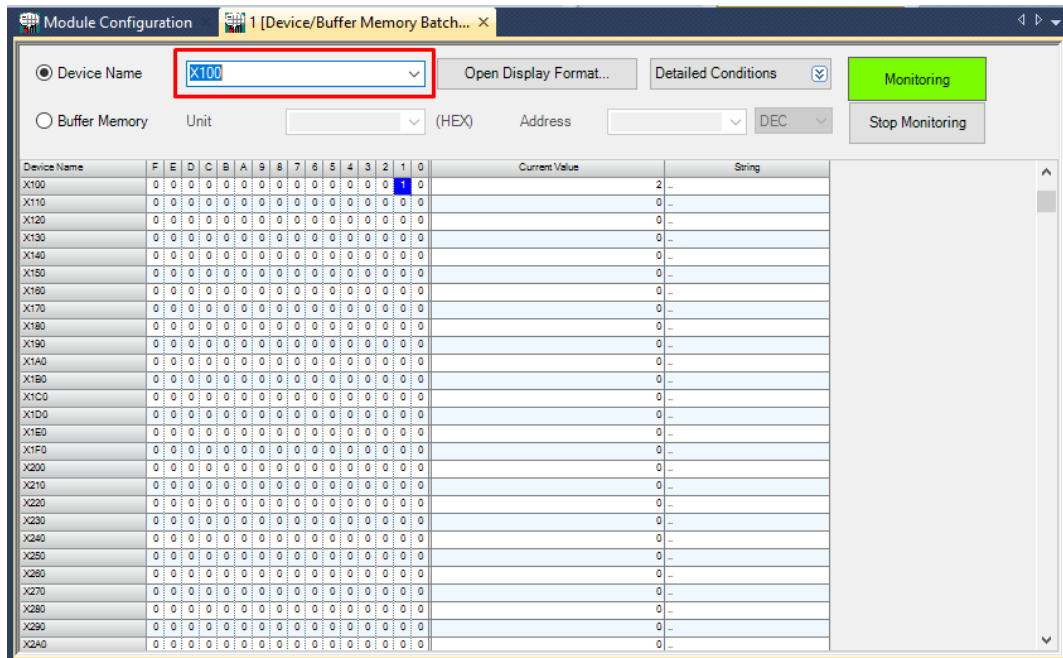

Fig. 85: GX Works3: Monitoring of process data

- ⇒ The mapping shows a signal at the 2nd Digital input of the 1st CC-Link device (station address 2, TBEN-LL-8DIP-8DOP) [▶ 146].

7.10 Commissioning IO-Link devices

7.10.1 Commissioning IO-Link device-Link devices via IO-Link Device Application

The IO-Link devices connected to the IO-Link master can be commissioned via generic or device-specific IODDs in the IO-Link Device Application. The IO-Link Device Application is called up via the web server of the IO-Link device-Link master module.



NOTE

To be able to call up the IO-Link Device Application, a login to the web server of the IO-Link master is required [▶ 36].

Connected IO-Link devices are read in and initially mapped by a generic IODD.

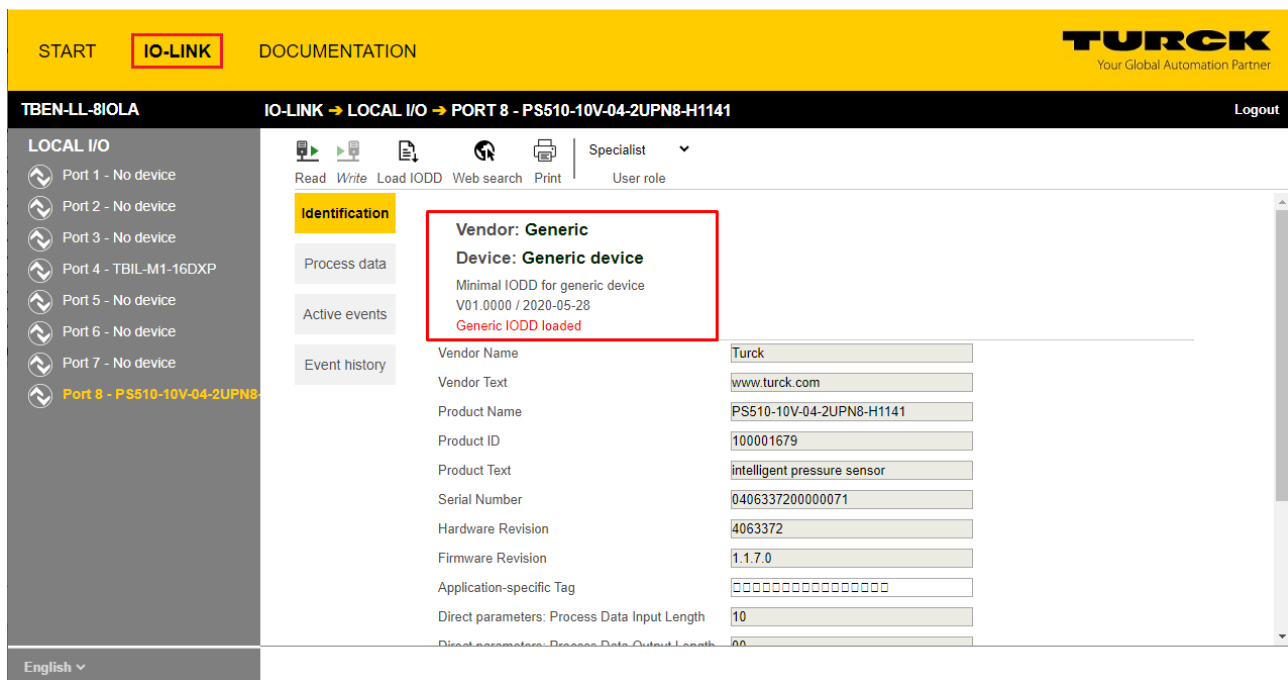

Fig. 86: IO-Link device with generic IODD

Device-specific IODDs can be loaded either directly from the local file system via **Load IODD** or from the database of the IO-Link consortium via **Websearch**. A PC with Internet access is required for the **Websearch** function.

When using a device-specific IODD, the IO-Link device is mapped with all IO-Link device-specific parameters, process data, etc. that are defined in the IODD.

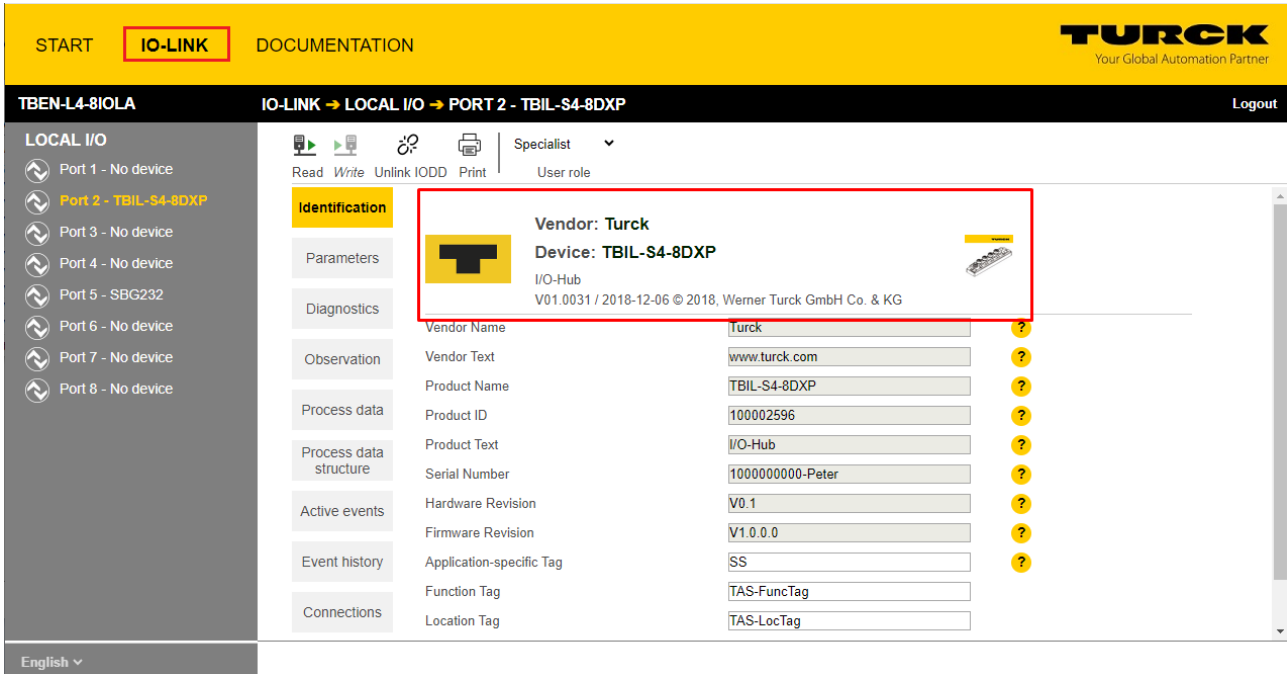

Fig. 87: IO-Link device with device specific IODD

Unlink IODD disconnects the connection to the device-specific IODD and causes the IO-Link device to be mapped again by a generic IODD. **Print** can be used to print the respective page content or save it as a PDF file, e.g., for system documentation.

Parameter settings for IO-Link devices can be exported or imported as *.json files in the **Parameter** section. **Set defaults** resets the values in the IO-Link Device Application interface to default settings. To reset IO-Link devices, the **RESTORE FACTORY SETTINGS** system command must be executed.

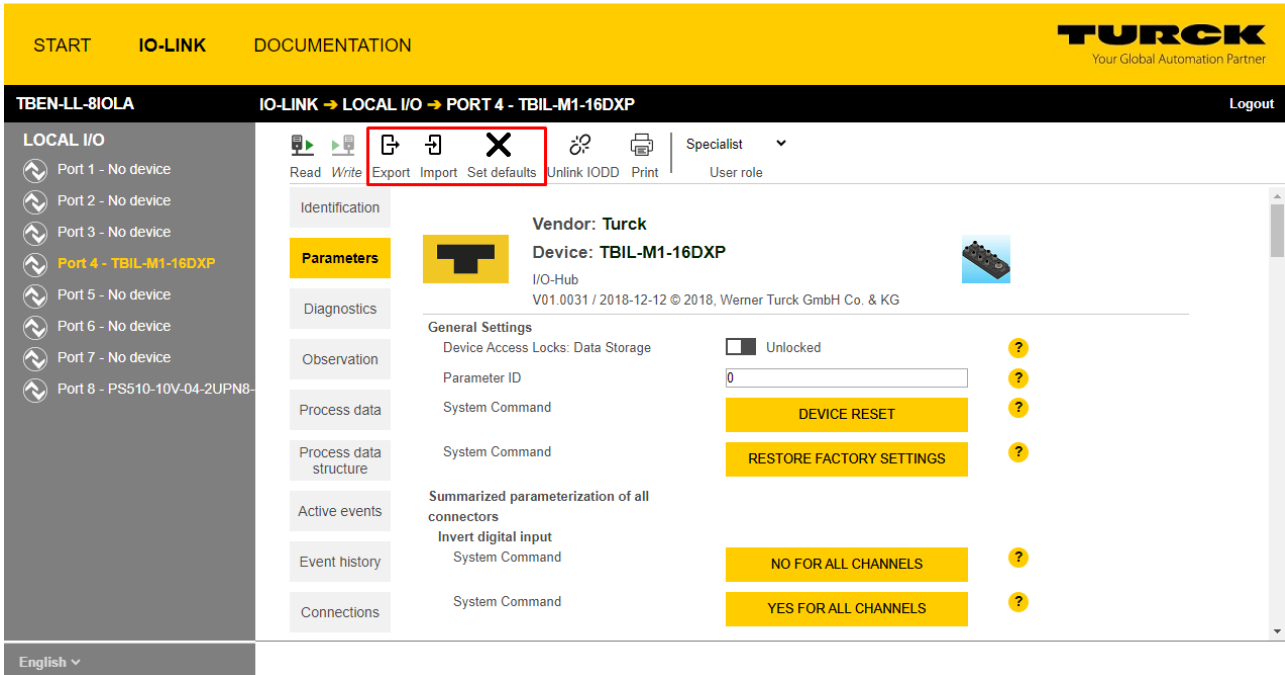

Fig. 88: Parameters of the IO-Link device

7.10.2 Commissioning IO-Link devices via SIDI (PROFINET only)

The IO-Link devices are defined in the GSMDL file of the IO-Link master. They can be selected directly in PROFINET engineering and assigned to the IO-Link ports of the IO-Link master module.

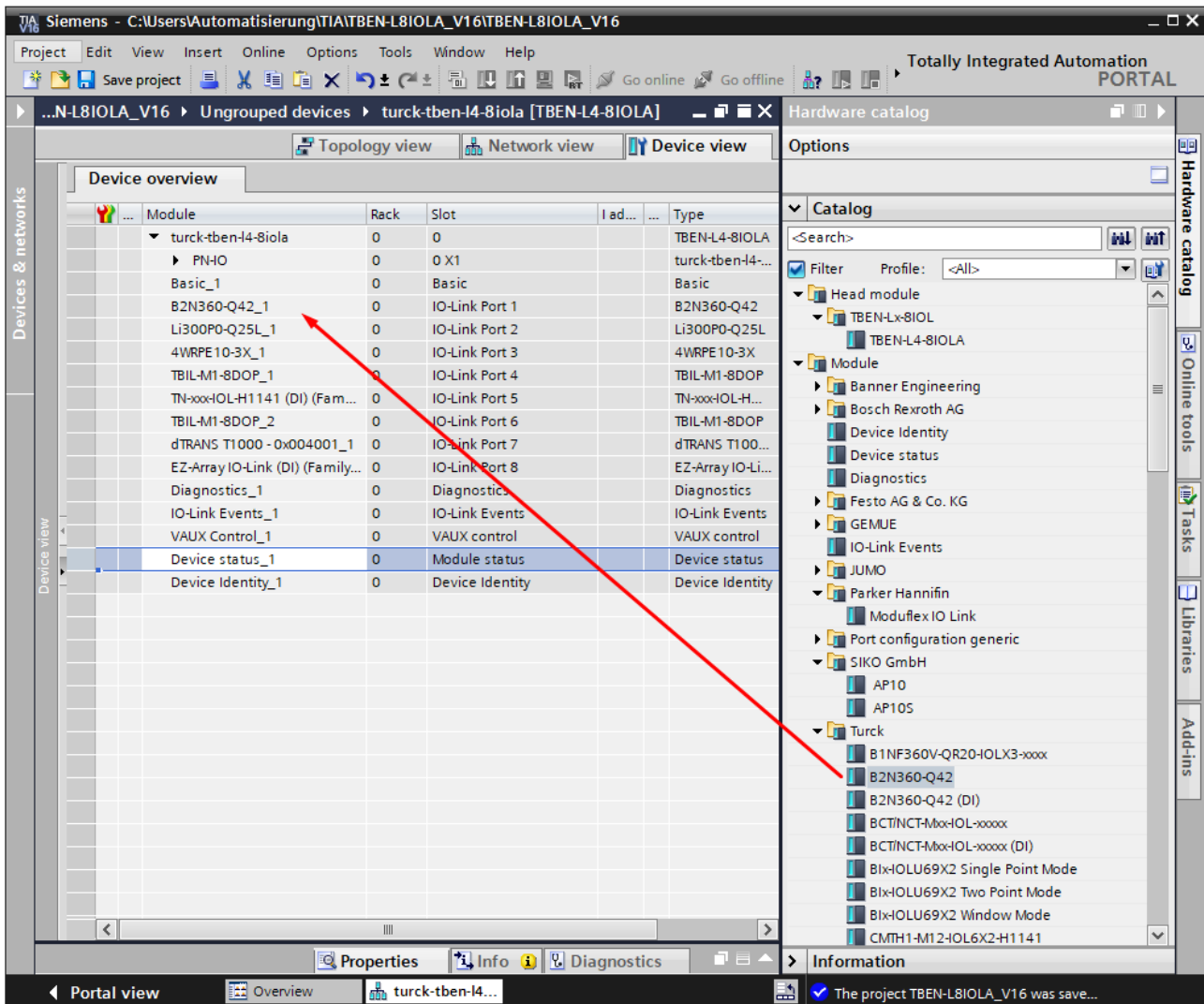

Fig. 89: Example: TIA Portal, IO-Link device in hardware catalog (SIDI)

Parameterizing IO-Link devices via PROFINET engineering

To be able to parameterize IO-Link devices via the GSDML, the "Device parameterization via GSD" parameter must be activated on the IO-Link master port (default setting).

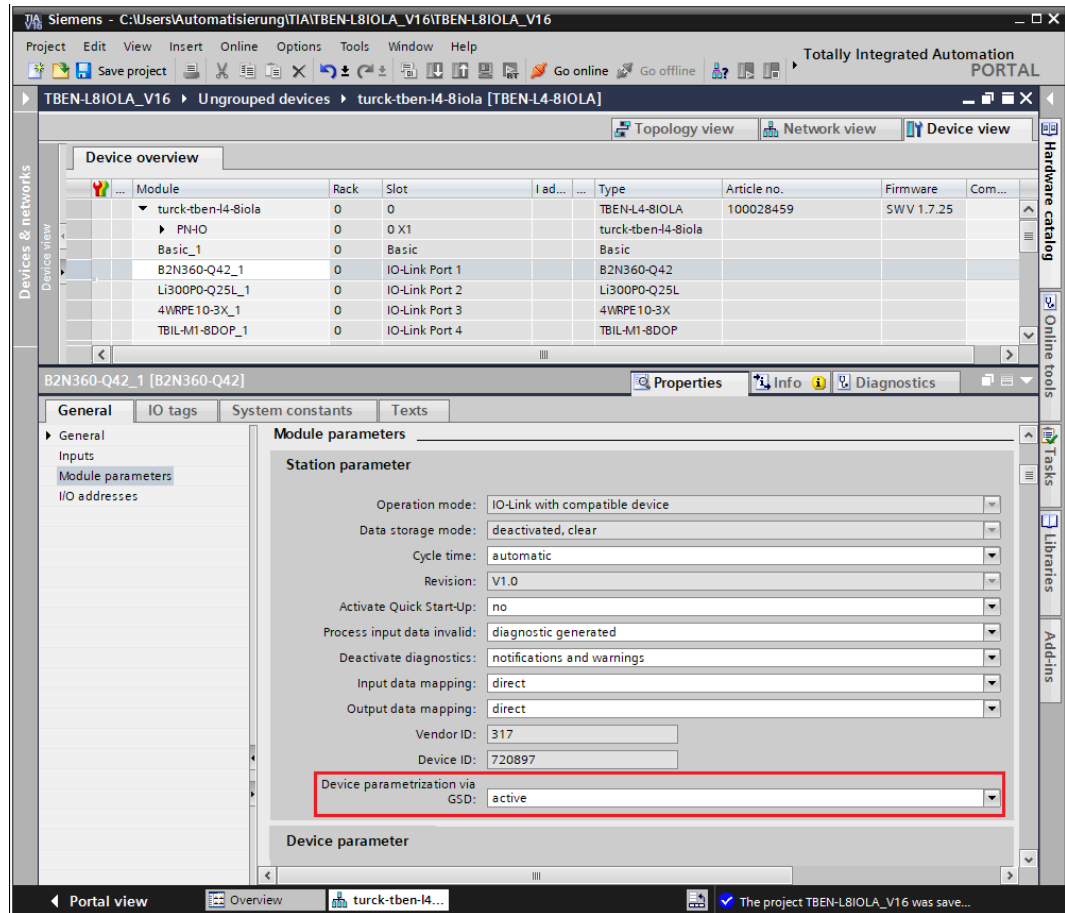

Fig. 90: Example: TIA Portal, "Device parameterization via GSD" parameter

The parameters of the IO-Link devices are set directly in PROFINET engineering.

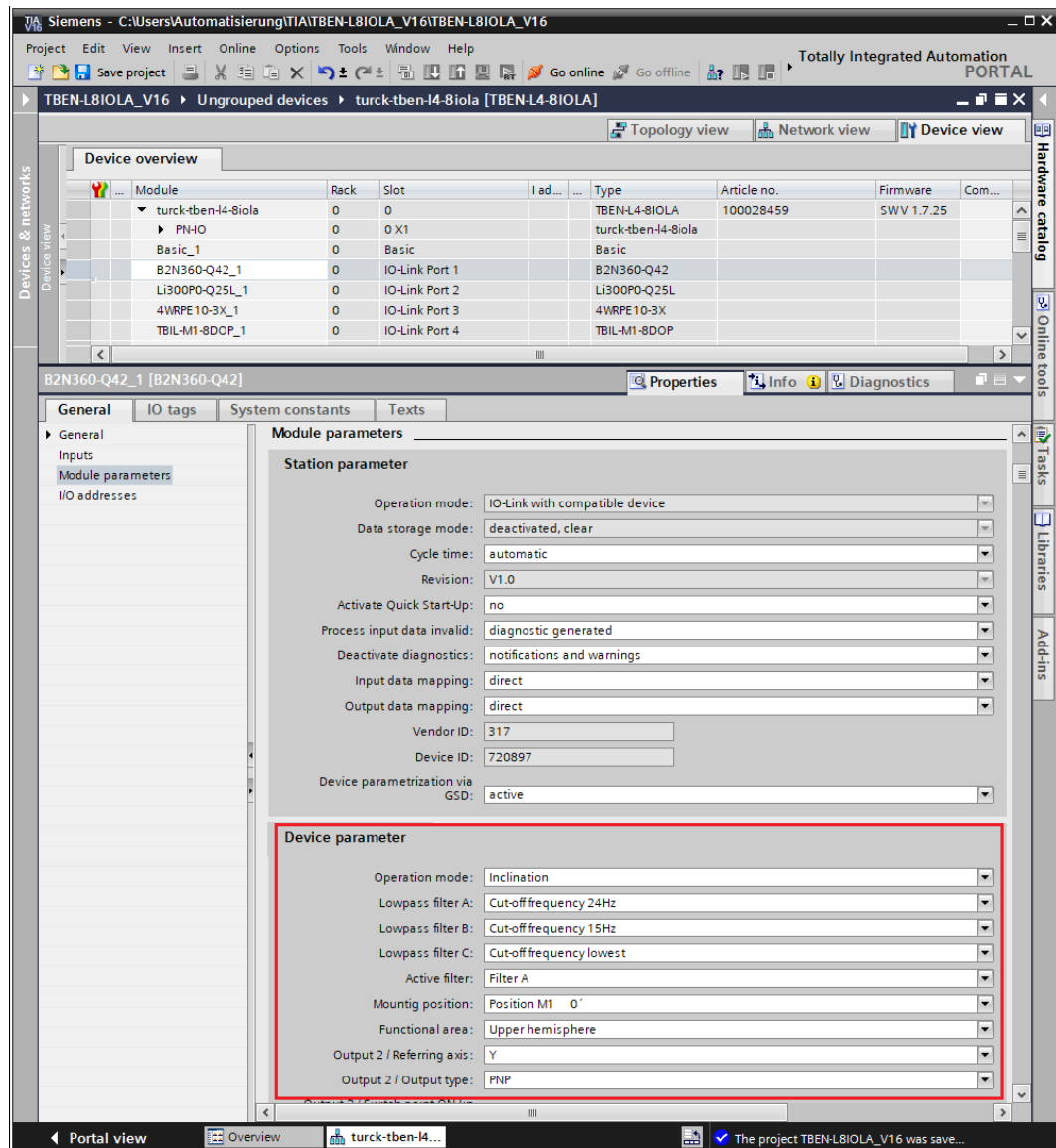

Fig. 91: Example: TIA Portal, IO-Link device parameters via GSDML

The parameterization of the IO-Link devices is controlled by the PLC. After a restart or an IO-Link device exchange, the start-up parameters stored in the PLC are written to the connected IO-Link devices. Parameter settings made during runtime either via the PLC (e.g., via IO-Link call accesses), directly at the IO-Link device (e.g., via operating elements) or at the IO-Link master (e.g., via web server or DTM) only apply temporarily and are overwritten with the parameter settings from the PLC at every restart.

Various IO-Link port parameters (station parameters) such as "operating mode", "data retention mode", "manufacturer ID" and "device ID" are defined via the GSDML file and cannot be changed.



NOTE

Data storage [▶ 197] is not possible when configuring IO-Link devices with SIDI.

Parameterizing IO-Link devices via IO-Link mechanisms

The "Device parameterization via GSD" parameter must be deactivated. Parameters and process data structures of the IO-Link devices are structured via the GSDML and displayed in PROFINET engineering (e.g., in CODESYS) in a device-specific manner. However, parameter handling is performed via IO-Link mechanisms (e.g., data management).

The screenshot shows the CODESYS interface for a project named 'TBEN-LL-8IOLA'. The left sidebar displays a tree view of the project structure, including 'Application', 'PLC Logic', 'Task Configuration', 'Ethernet (Ethernet)', and 'PN_Controller (PN-Controller)'. The main window shows the 'Settings' for the selected device, 'TBEN_LL_8IOLA (TBEN-LL-8IOLA)'. The 'Settings' window has a 'Mapping' section on the left and a 'Parameters' table on the right. The 'Parameters' table has columns for 'Parameters', 'Value', 'Datatype', 'Allowed values', and 'Des'. The parameter 'Device parameterization via GSD' is highlighted in red and has a value of 'inactive'. Other parameters include 'Station parameter', 'Operation mode', 'Data storage mode', 'Cycle time', 'Activate Quick Start-Up', 'Process input data invalid', 'Deactivate diagnostics', 'Input data mapping', 'Output data mapping', 'Vendor ID', 'Device ID', 'Undervoltage value diagnoses', and various connector parameters.

Parameters	Value	Datatype	Allowed values	Des
Station parameter				
Operation mode	IO-Link with compatible device	BitArea		
Data storage mode	deactivated, clear	BitArea		
Cycle time	automatic	BitArea		
Activate Quick Start-Up	yes	Bit		
Process input data invalid	diagnostic generated	Bit		
Deactivate diagnostics	notifications and warnings	BitArea		
Input data mapping	direct	BitArea		
Output data mapping	direct	BitArea		
Vendor ID	317	Unsigned16	0..65535	
Device ID	1974803	Unsigned32	0..4294967295	
Device parameterization via GSD	inactive	Bit		
Undervoltage value diagnoses	Standard (IEC 61131-2)	Bit		
Connector 0, Pin 4 / Invert digital input	no	Bit		
Connector 0, Pin 4 / Pulse stretching input	0	Unsigned8	0..255	
Connector 0, Pin 4 / Activate output	yes	Bit		
Connector 0, Pin 4 / Manual output reset after overcurrent	no	Bit		
Connector 0, Pin 4 / Output after error	0	BitArea		
Connector 1, Pin 4 / Invert digital input	no	Bit		
Connector 1, Pin 4 / Pulse stretching input	0	Unsigned8	0..255	

Fig. 92: PROFINET engineering (CODESYS); Device parameterization via GSD inactive

The screenshot shows the CODESYS interface for a project named 'TBEN-LL-8IOLA'. The left-hand 'Devices' pane shows a tree structure where 'IO_Link_Port_1_1 (TBIL-S3-8DXP)' is selected under the 'Basic (DXP)' sub-device. The main workspace displays the 'Process data structure' for this device, showing a table of variables and their mappings.

Variable	Mapping	Channel	Address	Type	Unit	Desc
		Inputs	%IB 10			
		Process input data	%IB 10	USINT		
		Input 0	%IX 10.0	BOOL		
		Input 1	%IX 10.1	BOOL		
		Input 2	%IX 10.2	BOOL		
		Input 3	%IX 10.3	BOOL		
		Input 4	%IX 10.4	BOOL		
		Input 5	%IX 10.5	BOOL		
		Input 6	%IX 10.6	BOOL		
		Input 7	%IX 10.7	BOOL		
		Process input data	%IB 11	USINT		
		Process input data	%IB 12	USINT		
		Process input data	%IB 13	USINT		
		Inputs PS	%IB 14	Enumeration of BYTE		
		Process output data	%QB 2	USINT		
		Output 0	%QX 2.0	BOOL		
		Output 1	%QX 2.1	BOOL		
		Output 2	%QX 2.2	BOOL		
		Output 3	%QX 2.3	BOOL		
		Output 4	%QX 2.4	BOOL		
		Output 5	%QX 2.5	BOOL		
		Output 6	%QX 2.6	BOOL		
		Output 7	%QX 2.7	BOOL		
		Outputs CS	%IB 15	Enumeration of BYTE		

At the bottom of the table, there are controls for 'Reset mapping' and 'Always update variables: Use parent device setting'. Below the table, there are icons for 'Create new variable' and 'Map to existing variable'.

Fig. 93: PROFINET engineering (CODESYS): Process data structure IO-Link device with SIDI

7.10.3 IO-Link network scan in TAS desktop

The IO-Link network scan in TAS-Desktop scans a connected network for IO-Link masters and IO-Link devices connected to them.

- ▶ Scan network for IO-Link devices in the IO-Link view of TAS desktop via **Scan network**.

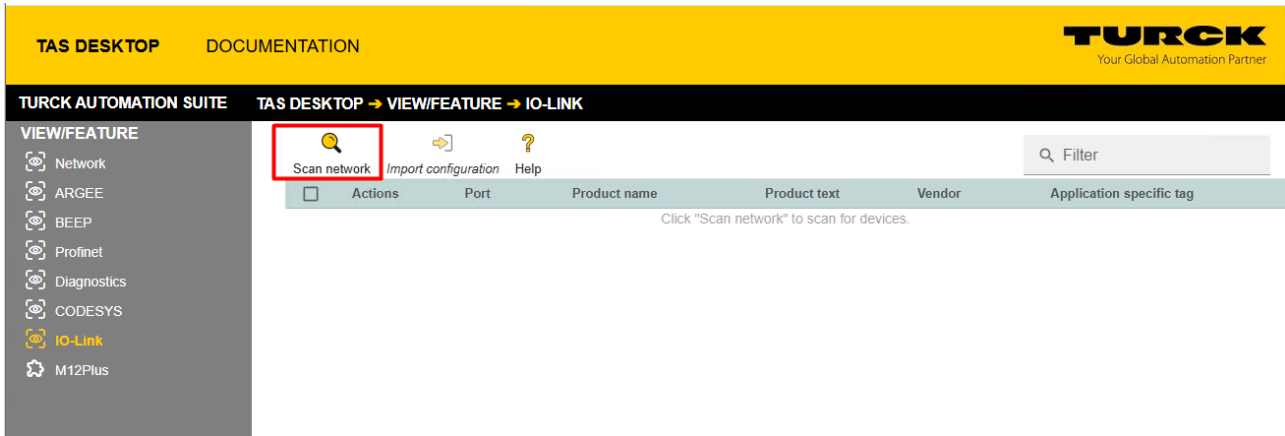

Fig. 94: TAS - scan network for IO-Link devices

- ⇒ All IO-Link masters connected in the network, including the connected I/O-Link devices, are displayed.

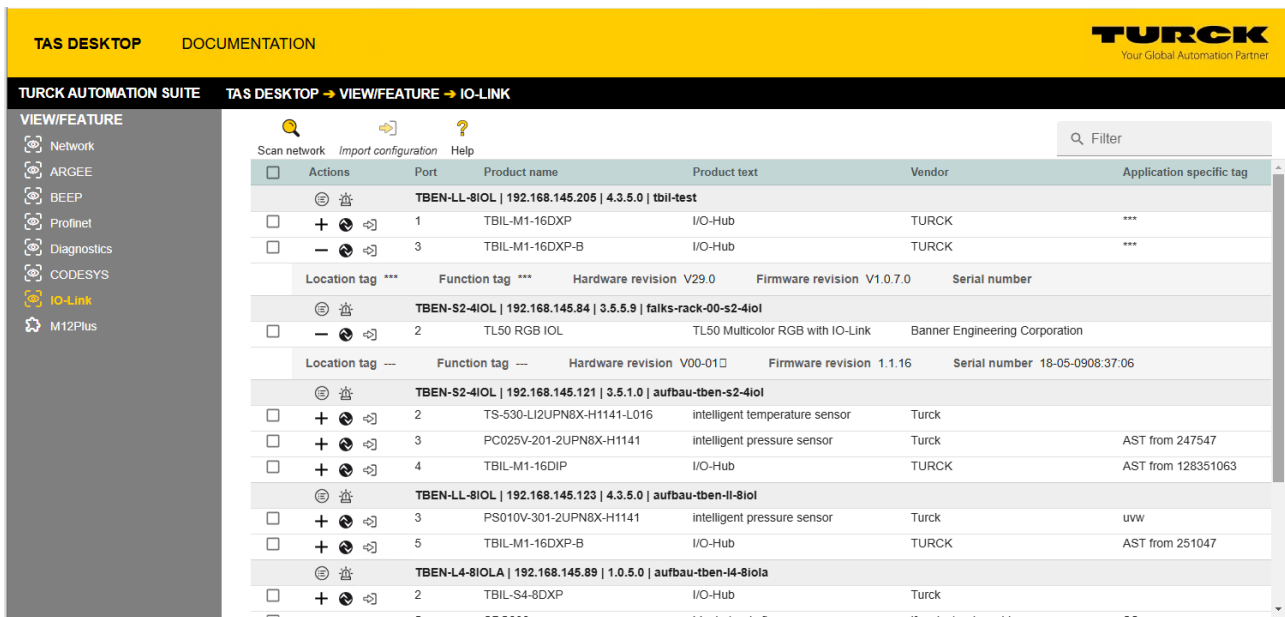

Fig. 95: TAS - IO-Link masters and devices found

Click on the **Open IO-Link in TAS** button to open the IO-Link device application [▶ 157].

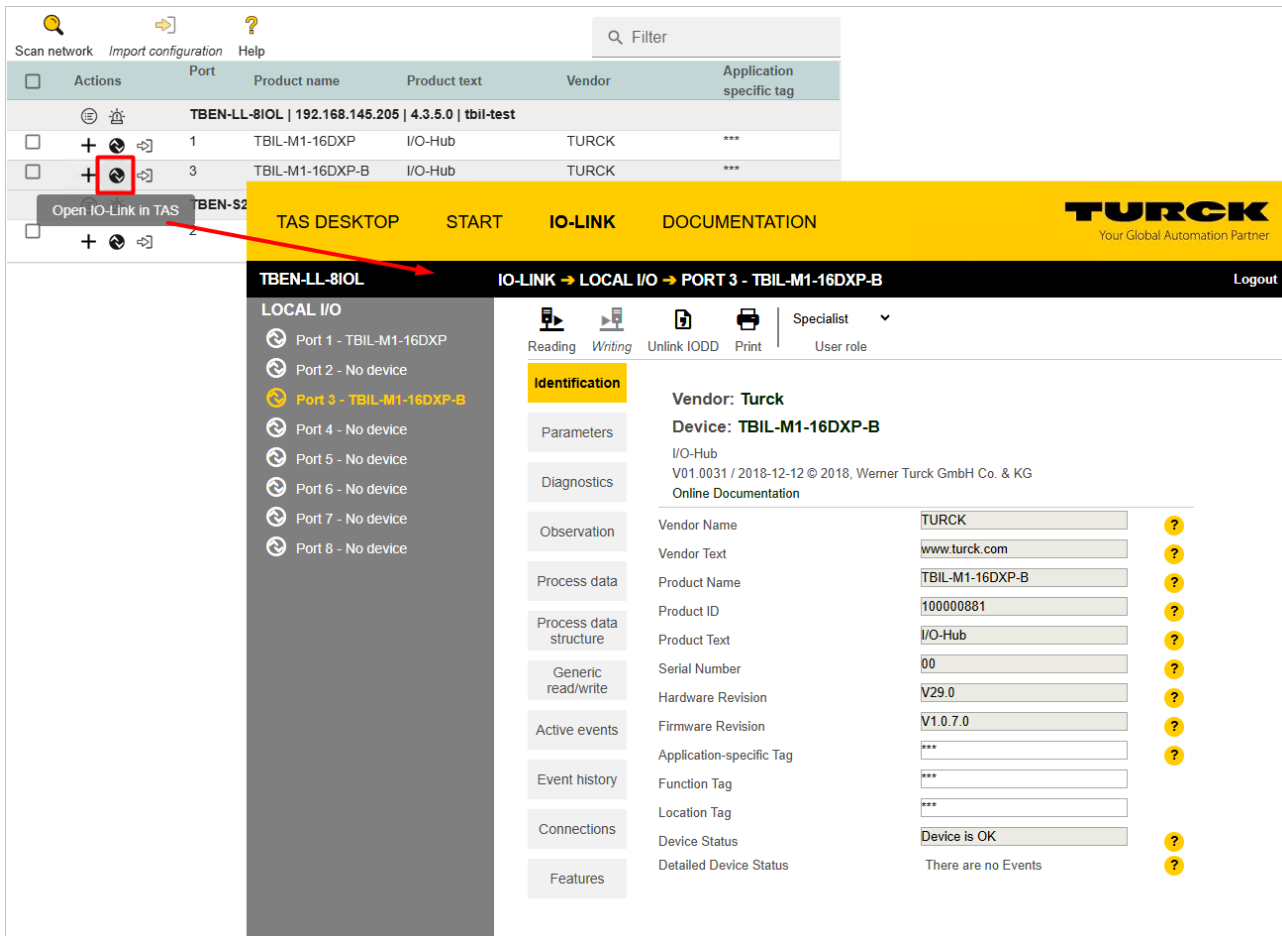

Fig. 96: IO-Link view - Open IO-Link device application

The **Import IO-Link configuration** button can be used to load a previously saved IO-Link device configuration into a new IO-Link device (example: device replacement).

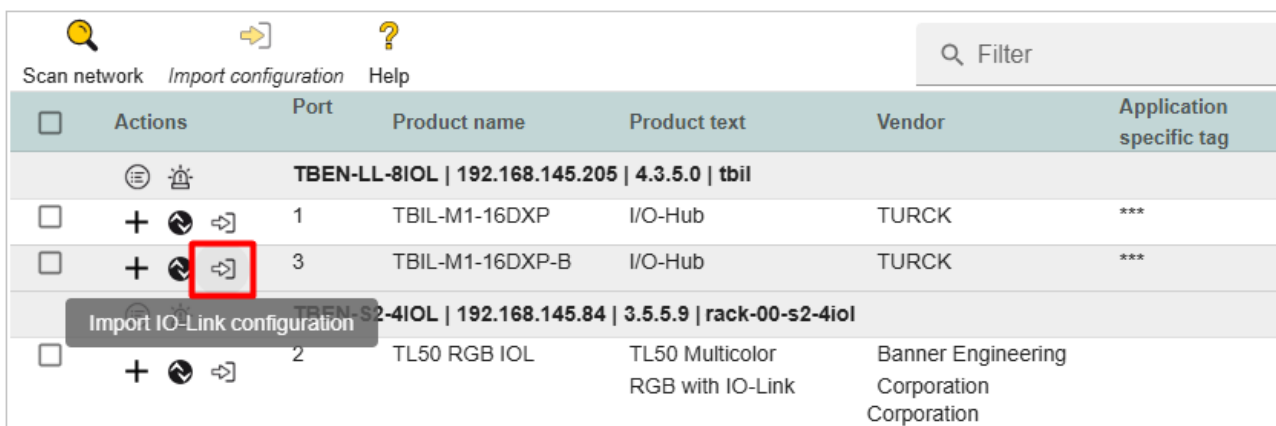

Fig. 97: IO-Link view 0 import IO-Link configuration

7.10.4 Commissioning IO-Link devices V1.0 (data storage)

IO-Link devices in accordance with IO-Link specification V1.0 do not support data storage. If an IO-Link V1.0 device is used, data storage on the IO-Link port of the IO-Link master must be deactivated, e.g. via the web server or via TAS Desktop.

Deactivating data storage (example: TAS)

- ▶ Set **Data storage mode** at the port to **deactivated, clear**.
- ▶ Use **Writing** to write the parameterization into the device.
- ▶ Connect the IO-Link V1.0 device.
- ⇒ The LED IOL at the IO-Link port is green, IO-Link communication active.

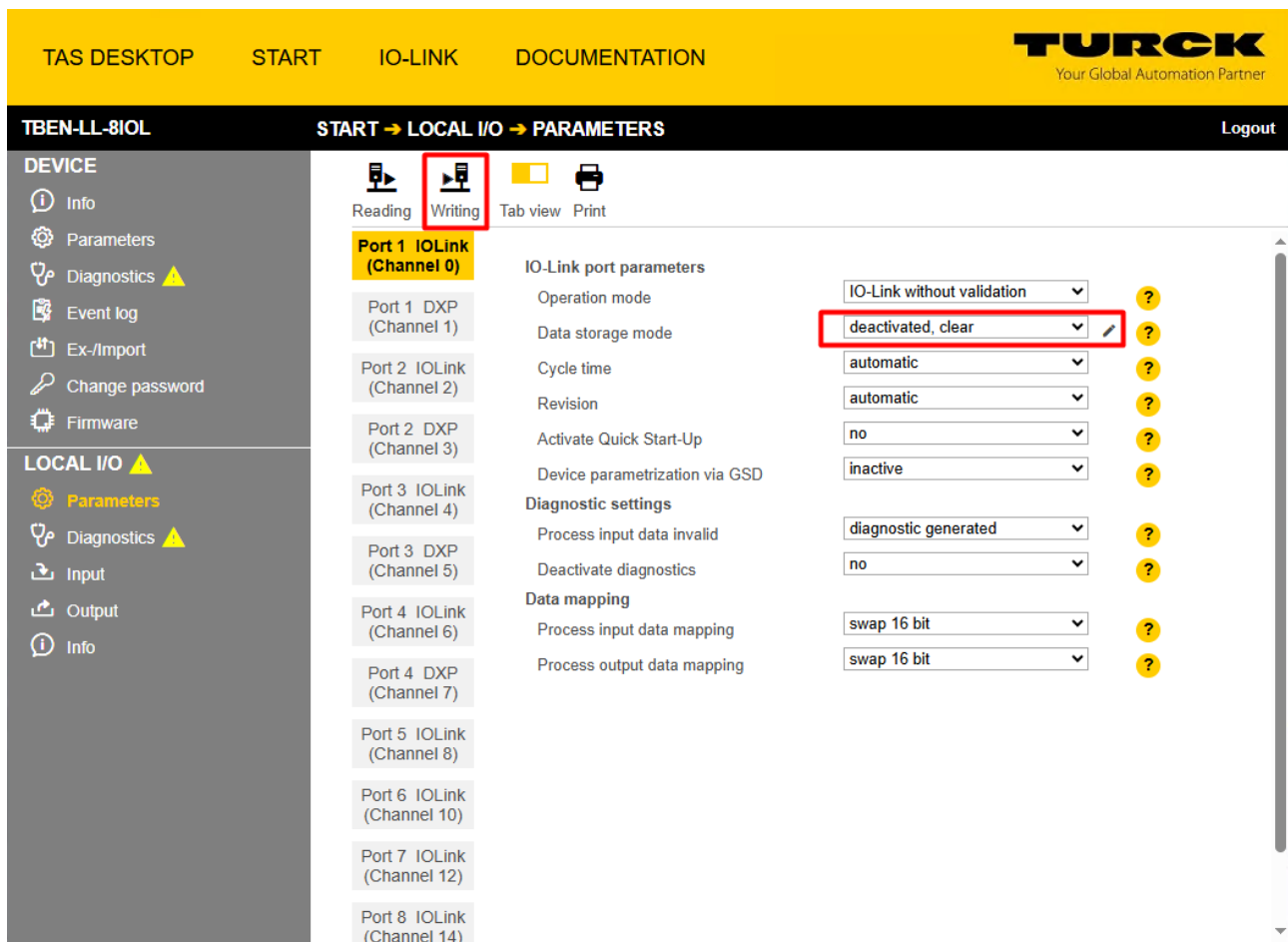

Fig. 98: TAS – deactivate data storage

7.10.5 Commissioning IO-Link devices V1.1 (data storage)

If another device type is connected to an IO-Link port that has already been used, the data storage memory of the master should first be deleted, e.g. via the web server of the IO-Link master or via TAS.

The data storage memory of the master can be deleted in two ways:

- Reset the IO-Link master to the factory settings.
- Delete the data storage memory of the IO-Link master via the **Data storage mode** parameter.

Reset the IO-Link master to factory settings (example: TAS)

- ▶ In TAS Desktop, reset the IO-Link master to factory settings via **Start → Device → Parameter** by clicking **Factory reset and reboot** → **Execute reset**.

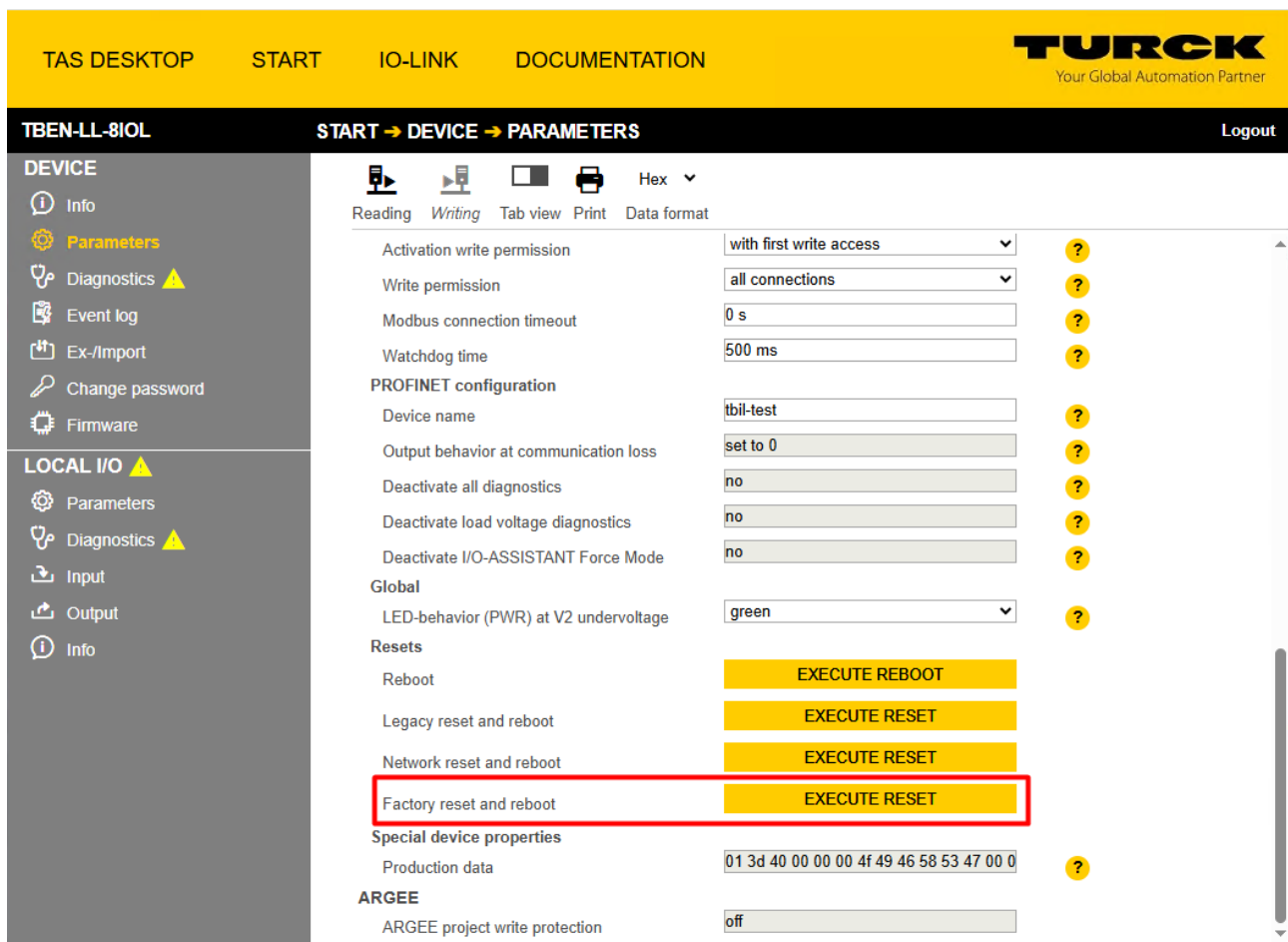

Fig. 99: TAS – resetting the device to factory settings

- ⇒ The device is reset.

Deleting the data storage memory via parameters (example: TAS)

- ▶ Set the parameter **Data storage mode** to **deactivated, clear**.
- ▶ Use **Writing** to write the parameter changes into the device.

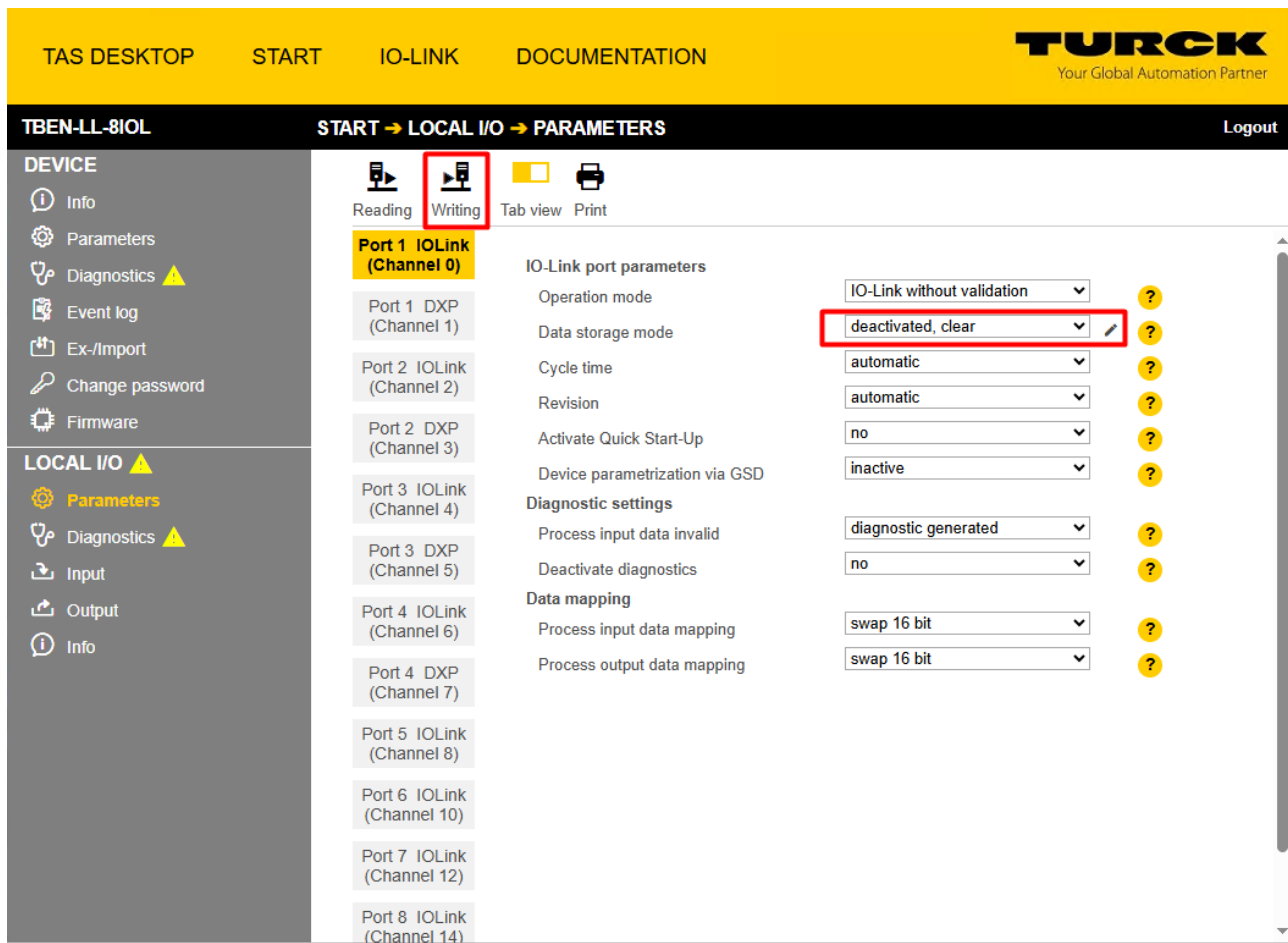

Fig. 100: TAS: deleting the data storage memory via parameters

- ▶ Re-activate the data storage, if necessary and write the parameter changes into the device via **Writing**.
- ▶ Connect the IO-Link V1.1 device.
- ⇒ The LED IOL at the IO-Link port is green, IO-Link communication active.

8 Parameterizing and configuring

8.1 Parameters

The device has 4 bytes of module parameters, 16 bytes each of IO-Link port parameters and 16 bytes of parameters for VAUX1/VAUX2 monitoring.

Word no.	Bit no.																
	15	14	13	12	11	10	9	8	7	6	5	4	3	2	1	0	
Basic																	
0x00	-	-	-	-	-	-	-	-	DXP7_ SRO	-	DXP5_ SRO	-	DXP3_ SRO	-	DXP1_ SRO	-	
0x01	-	-	-	-	-	-	-	-	DXP7_ EN DO	-	DXP5_ EN DO	-	DXP3_ EN DO	-	DXP1_ EN DO	-	
IO-Link port 1																	
0x02	Cycle time								GSD	Activate quick start-up	Data storage mode	Operation mode					
0x03	-								Mapping PCDO		Mapping PDIN		Deactivate diag.		PDIN invalid	Rev.	
0x04... 0x05	-								-	-	-	-	-	-	-	-	
0x06	Vendor ID (MSB)								Vendor ID (LSB)								
0x07	Device ID								Device ID (LSB)								
0x08	Device ID (MSB)								Device ID								
0x09	-	-	-	-	-	-	-	-	-	-	-	-	-	-	-	-	
IO-Link port 2																	
0x0A... 0x11	Assignment similar to IO-Link port 1 (word 0x02...0x09)																
IO-Link port 3																	
0x12... 0x19	Assignment similar to IO-Link port 1 (word 0x02...0x09)																
IO-Link port 4																	
0x1A... 0x21	Assignment similar to IO-Link port 1 (word 0x02...0x09)																
IO-Link port 5																	
0x22... 0x29	Assignment similar to IO-Link port 1 (Word 0x02...0x09)																
IO-Link port 6																	
0x2A... 0x31	Assignment similar to IO-Link port 1 (Word 0x02...0x09)																
IO-Link port 7																	
0x32... 0x39	Assignment similar to IO-Link port 1 (Word 0x02...0x09)																

Word no.	Bit no.															
	15	14	13	12	11	10	9	8	7	6	5	4	3	2	1	0
IO-Link port 8																
0x3A... 0x41	Assignment similar to IO-Link port 1 (Word 0x02...0x09)															
VAUX monitoring																
0x42	-	-	-	-	-	-	VAUX1 pin1 C1 (ch2/3)	-	-	-	-	-	-	-	-	VAUX1 pin1 C0 (ch0/1)
0x43	-	-	-	-	-	-	VAUX1 pin1 C3 (ch6/7)	-	-	-	-	-	-	-	-	VAUX1 pin1 C2 (ch4/5)
0x44	-	-	-	-	-	-	VAUX1 pin1 C5 (ch10)	-	-	-	-	-	-	-	-	VAUX1 pin1 C4 (ch8)
0x45	-	-	-	-	-	-	VAUX1 pin1 C7 (ch14)	-	-	-	-	-	-	-	-	VAUX1 pin1 C6 (ch12)
0x46... 0x47	-	-	-	-	-	-	-	-	-	-	-	-	-	-	-	-
0x48	-	-	-	-	-	-	VAUX2 pin2 C5 (ch11)	-	-	-	-	-	-	-	-	VAUX2 pin2 C4 (ch9)
0x49	-	-	-	-	-	-	VAUX2 pin2 C7 (ch15)	-	-	-	-	-	-	-	-	VAUX2 pin2 C6 (ch13)

The default values are written in **bold**.

Parameter name	Value		Meaning		Description
	Dec.	Hex.			
Manual output reset after overcurrent (DXP..._SRO)	0	0x00	No		The output switches on automatically after an overload.
	1	0x01	Yes		The output is manually switched-off after an overload until a new set command is given (rise and fall).
Activate output Ch... (DXP..._ENDO)	0	0x00	No		The output at pin 2 is deactivated.
	1	0x01	Yes		The output at pin 2 is activated.
Operation mode	0	0x00	IO-Link without validation		Pin 4 is operated in IO-Link mode. The master does not check if the connected device matches the configured one.
	1	0x01	IO-Link with family compatible device		Pin 4 is operated in IO-Link mode. The master checks if the Vendor ID and the MSB of the Device ID (this byte defines the product family) of the connected device match those of the configured one. If the master detects a mismatch, the IO-Link communication is established, but there is no process data exchange. The device remains in the safe state (Pre-Operate). Parameters and diagnostic information can be read and respectively written.

Parameter name	Value		Meaning	Description
	Dec.	Hex.		
	2	0x02	IO-Link with compatible device	<p>Pin 4 is operated in IO-Link mode. The master checks if the Vendor ID and the Device ID of the connected device match those of the configured one. If the Vendor ID matches, but the Device ID not, then the master tries to write the Device ID to the device. If the writing is successful, then the device is a compatible one, process data exchange is possible. If writing the Device ID is not successful, then process data exchange is not possible. The device remains in the safe state (Pre-Operate). Parameters and diagnostic information can be read and respectively written.</p>
	3	0x03	IO-Link with identical device	<p>Pin 4 is operated in IO-Link mode. The master checks if the device type (Vendor ID and Device ID) and the serial number of the connected device match the data of the configured one. If the master detects a mismatch, the IO-Link communication is established, but there is no process data exchange. The device remains in the safe state (Pre-Operate). Parameters and diagnostic information can be read and respectively written.</p>
	4	0x04	DI (with parameter access)	<p>Pin 4 is generally operated as simple digital input. An acyclic parameter access from the PLC or the DTM is possible. The IO-Link master starts the port in IO-link mode, parameterizes the device and sets the port back into SIO mode (DI). The port remains in SIO mode (DI) until a new IO-Link request is sent from the higher-level control. Data storage is not supported. Connected devices have to support the SIO mode (DI). In case of a parameter access, the IO-Link communication at the port is started. Switching signals are interrupted.</p>
	8	0x08	DI	<p>Pin 4 is operated as simple digital input. Data storage is not supported.</p>

Parameter name	Value		Meaning	Description
	Dec.	Hex.		
Data Storage Mode	Synchronization of parameter data of IO-Link devices (storing the parameter of the connected device in the master). If the synchronization is not possible, a diagnostic message is displayed (DS_ERR). In this case the data memory of the master must be deleted: ▶ Select option "deactivated, delete" to delete the data memory of the master IO-Link devices in accordance with IO-Link specification V1.0 do not support data storage. When using IO-Link devices with IO-Link V1.0: ▶ Select option "deactivated, delete" to deactivate data storage.			
	0	0x00	Activated	Synchronization of parameter data activated. The actual data (master or device) serve as the reference data.
	1	0x01	Overwrite	Synchronization of parameter data activated, the data in the master serve as reference data.
	2	0x02	Read in	Synchronization of parameter data activated. The data in the connected IO-Link device serve as reference data.
	3	0x03	Deactivated, clear	Synchronization of parameter data deactivated. The data set in the master is deleted.
Activate Quick Start-Up	For fast applications (e.g. tool changing applications) the start-up time of IO-Link devices can be shortened. The start-up time defined in the IO-Link specification (TSD = Device Detection Time) is reduced.			
	0	0x00	No	The start-up time is within the specified range (0.5 s). All IO-Link devices in accordance with the specification can be operated.
	1	0x01	Yes	The start-up time is reduced to approx. 100 ms. It is not supported by every IO-Link device. It can thus be necessary to check if the used IO-Link device starts in this mode.
Device parameterization via GSD (GSD)	0	0x00	Inactive	The port is generic or is not parameterized.
	1	0x01	Active	In PROFINET the port is parameterized with a specific device type from the GSDML-file (SID).
Cycle time	0	0x00	Automatic	The lowest cycle time supported by the device is taken from the table.
	16... 191	0x10 ... 0xBF	1.6 = 132,8 ms	Settable in steps of 0.8 or 1.6 ms.
	255	0xFF	Automatic, compatible	Compatibility mode The mode solves possible communication problems with sensors of the SGB family from IFM.
Revision	0	0x00	Automatic	The Master defines the IO-Link revision automatically.
	1	0x01	V1.0	IO-Link Revision V 1.0 is used.
Process input data invalid (PDIN invalid)	0	0x00	Diagnostic generated	If the process data are invalid, a respective diagnostic message is generated.
	1	0x01	No diagnostic generated	Invalid process data do not cause a diagnostic message.

Parameter name	Value		Meaning	Description
	Dec.	Hex.		
Deactivate diagnostics	Influences the sending of IO-Link-Events from the master to the fieldbus. Depending on the parameterization, the master transmits Events based on their priority to the fieldbus or not.			
	0	0x00	No	The master transmits all IO-Link Events to the fieldbus.
	1	0x01	Notifications	The master transmits all IO-Link Events to the fieldbus except for IO-Link notifications.
	2	0x02	Notifications and warnings	The master transmits all IO-Link Events to the fieldbus except for IO-Link notifications and warnings.
	3	0x03	Yes	The master doesn't transmit any IO-Link Event to the fieldbus.
Process input data mapping (Mapping PDIN)	Optimization of the process data mapping for the used fieldbus: The I/O-Link-data can be swapped depending on the used fieldbus in order to achieve an optimized data mapping on the fieldbus side. PROFINET: With PROFINET, the parameter is permanently set to 0x00 = direct and cannot be changed.			
	0	0x00	Direct	The process data are not swapped. i.e.: 0x0123 4567 89AB CDEF
	1	0x01	Swap 16 bit	The bytes are swapped per word. i.e.: 0x2301 6745 AB89 EFCD
	2	0x02	Swap 32 bit	The bytes are swapped per double word. i.e.: 0x6745 2301 EFCD AB89
	3	0x03	Swap all	All bytes are swapped. i.e.: 0xEFCD AB89 6745 2301
Process output data mapping (Mapping PDOOUT)	see above Process input data mapping			
Vendor ID	0...65535 0x0000...0xFFFF		Vendor ID for the port configuration check	
Device ID	0...16777215 0...0x00FFFFFF		Device ID for the port configuration check, 24 bit value	
VAUX1 pin 1 Cx (Ch...)	0	0x00	24 VDC	The 24 VDC sensor/actuator supply at pin1 of the respective connector is switched on.
	1	0x01	switchable	The 24 VDC sensor/actuator supply at pin1 of the respective connector is switchable via the process data.
	2	0x02	off	The 24 VDC sensor/actuator supply at pin1 of the respective connector is switched off.
VAUX2 pin 2 Cx (Ch...)	0	0x00	24 VDC	The Class B supply at pin2 of the respective connector is switched on.
	1	0x01	switchable	The Class B supply at pin 2 of the respective connector is switchable via the process data.
	2	0x02	off	The Class B supply at pin2 of the respective connector is switched off.

Values for the parameter "cycle time" in ms:

Time	Value	Time	Value	Time	Value	Time	Value	Time	Value	Time	Value		
Auto	0x00	16	0x58	31.2	0x7E	60.8	0x92	91.2	0xA5	121.6	0xB8		
1.6	0x10	16.8	0x5A	32	0x80	62.4	0x93	92.8	0xA6	123.2	0xB9		
2.4	0x18	17.6	0x5C	33.6	0x81	64	0x94	94.4	0xA7	124.8	0xBA		
3.2	0x20	18.4	0x5E	35.2	0x82	65.6	0x95	96	0xA8	126.4	0xBB		
4	0x28	19.2	0x60	36.8	0x83	67.1	0x96	97.6	0xA9	128	0xBC		
4.8	0x30	20	0x62	38.4	0x84	68.8	0x97	99.2	0xAA	129.6	0xBD		
5.6	0x38	20.8	0x67	40	0x85	70.4	0x98	100.8	0xAB	131.2	0xBE		
6.4	0x40	21.6	0x66	41.6	0x86	72	0x99	102.4	0xAC	132.8	0xBF		
7.2	0x42	22.4	0x68	43.2	0x87	73.6	0x9A	104	0xAD	Reserved			
8	0x44	23.2	0x6A	44.8	0x88	75.2	0x9B	105.6	0xAE				
8.8	0x46	24.0	0x6C	46.4	0x89	76.8	0x9C	107.2	0xAF				
9.6	0x48	24.8	0x6E	48	0x8A	78.4	0x9D	108.8	0xB0				
10.4	0x4A	25.6	0x70	49.6	0x8B	80	0x9E	110.4	0xB1				
11.2	0x4C	26.4	0x72	51.2	0x8C	81.6	0x9F	112	0xB2				
12.0	0x4E	27.2	0x74	52.8	0x8D	83.2	0xA0	113.6	0xB3				
12.8	0x50	28	0x76	54.4	0x8E	84.8	0xA1	115.2	0xB4				
13.6	0x52	28.8	0x78	56	0x8F	86.4	0xA2	116.8	0xB5				
14.4	0x54	29.6	0x7A	57.6	0x90	88	0xA3	118.4	0xB6				
15.2	1x56	30.4	0x7C	59.2	0x91	89.6	0xA4	120	0xB7			Auto., comp.	0xFF

8.1.1 Adapting process data mapping

The mapping of process data can be adapted application-specifically via the IO-Link-master's parameterization.

Depending on the used fieldbus, it can be necessary to swap process data word-wise, double word-wise or completely in order to align them to the data structure in the PLC. The process data mapping is determined channel by channel through the parameters **process input data mapping** and **process output data mapping**.

Example mapping for fieldbuses with Little Endian-format

Mapping through the IO-Link master → fieldbus → PLC						
Byte	Device at IO-Link port	Device process data in IO-Link master		Parameter: Process data mapping	Device process data to fieldbus	
Byte 0		Status/Control			Status/Control	
Byte 1						
IO-Link port 1						
Byte 2	Temperature sensor TS...	Temperature	Low byte	Swap 16 bit	Temperature	High byte
Byte 3			High byte			Low byte
IO-Link port 2						
Byte 4	Linear position sensor Li...	Position	Low byte	Swap 16 bit	position	High byte
Byte 5			High byte			Low byte
IO-Link port 3						
Byte 6	I/O hub TBIL-...	Digital signals	0...7	Direct	Digital signal	0...7
Byte 7		Digital signals	8...15		Digital signal	8...15
IO-Link port 4						
Byte 8		Diagnostics		Swap all	Counter/position value	Most Significant Byte
Byte 9	Rotary encoder RI...	Counter/position value	Low byte			High byte
Byte 10			High byte			Low byte
Byte 11			Most Significant Byte		Diagnostics	

8.1.2 PROFINET parameters

For PROFINET, a distinction must be made between the PROFINET device parameters and the parameters of the I/O channels.

PROFINET device parameters

Default values are shown in **bold**.

Parameter name	Value	Meaning	Description
Output behavior at communication loss	0	Set to 0	The device switches the outputs to "0". No error information is sent.
	1	Hold current value	The device keeps the current data at the outputs.
Deactivate all diagnostics	0	No	Diagnostic and alarm messages are generated.
	1	Yes	Diagnostic and alarm messages are suppressed.
Disable output power diagnosis	0	No	Monitoring of voltage V2 is activated.
	1	Yes	The sending of the diagnosis is deactivated.
LED behavior (PWR) at V2 undervoltage	0	Red	The PWR LED lights up red in the event of an undervoltage at V2.
	1	Green	The PWR LED is flashes green in the event of an undervoltage at V2.
Deactivate I/O-ASSISTANT Force Mode	0	No	
	1	Yes	The Force Mode of the DTM is deactivated.
Deactivate EtherNet/IP	0	No	Explicit disabling of the Ethernet protocols or the web server
	1	Yes	
Deactivate Modbus TCP	0	No	
	1	Yes	
Deactivate web server	0	No	
	1	Yes	

8.2 IO-Link functions for acyclic communication

The acyclic access to the data of IO-Link devices is realized via IO-Link CALLs. A distinction must be made between data of the IO-Link master (IOLM) and data of connected IO-Link devices (IOLD).

The addressing of the IO-Link CALL defines which device is addressed via the CALL:

The addressing is defined by the so called Entity_Port:

- Entity_Port 0 = IO-Link master module (IOLM)
- Entity_Port 1 = IO-Link device at IO-Link port 1
- ...
- Entity_Port 8 = IO-Link device at IO-Link port 8

8.2.1 Port functions for Port 0 (IO-Link Master)

IO-Link index (port function invocation)

The access to the IO-Link master functionalities (port 0) is done via index 65535.

Subindex 64: Master Port Validation Configuration

The object writes a specific configuration of the devices which have to be connected to the IO-Link port to the master. The master stores the data for the The IO-Link device expected at the port and then accepts only one device at the port with exactly matching data (vendor ID, device ID and serial number).

The Master Port Validation Configuration is only useful in combination with an operation mode with validation (**IO-Link with family compatible device, IO-Link with compatible device, IO-Link with identical device**).

Entity_Port	IO-Link sub index	Read/write	Length
0	64	Write	Max. 192 byte

Structure of the command IOL_Port_Config:

	Content	Size	Format	Comment
IOL1	VENDOR_ID	2 byte	Unsigned 16	
	DEVICE_ID	4 byte	Unsigned 32	
	FUNCTION_ID	2 byte	Unsigned 16	Value: 0
	SERIAL_NUMBER	16 byte	String	
IOL2	VENDOR_ID	2 byte	Unsigned 16	
	DEVICE_ID	4 byte	Unsigned 32	
	FUNCTION_ID	2 byte	Unsigned 16	Value: 0
	SERIAL_NUMBER	16 byte	String	
IOL3	VENDOR_ID	2 byte	Unsigned 16	
	DEVICE_ID	4 byte	Unsigned 32	
	FUNCTION_ID	2 byte	Unsigned 16	Value: 0
	SERIAL_NUMBER	16 byte	String	
IOL4	VENDOR_ID	2 byte	Unsigned 16	
	DEVICE_ID	4 byte	Unsigned 32	
	FUNCTION_ID	2 byte	Unsigned 16	Value: 0
	SERIAL_NUMBER	16 byte	String	

	Content	Size	Format	Comment
IOL5	VENDOR_ID	2 byte	Unsigned 16	
	DEVICE_ID	4 byte	Unsigned 32	
	FUNCTION_ID	2 byte	Unsigned 16	Value: 0
	SERIAL_NUMBER	16 byte	String	
IOL6	VENDOR_ID	2 byte	Unsigned 16	
	DEVICE_ID	4 byte	Unsigned 32	
	FUNCTION_ID	2 byte	Unsigned 16	Value: 0
	SERIAL_NUMBER	16 byte	String	
IOL7	VENDOR_ID	2 byte	Unsigned 16	
	DEVICE_ID	4 byte	Unsigned 32	
	FUNCTION_ID	2 byte	Unsigned 16	Value: 0
	SERIAL_NUMBER	16 byte	String	
IOL8	VENDOR_ID	2 byte	Unsigned 16	
	DEVICE_ID	4 byte	Unsigned 32	
	FUNCTION_ID	2 byte	Unsigned 16	Value: 0
	SERIAL_NUMBER	16 byte	String	

Subindex 65: IO-Link events

The object reads IO-Link Event diagnostics.

Entity_Port	IO-Link sub index	Read/write	Length
0	65	Read	255 byte



NOTE

Only "appears" (coming diagnostics) and "Single Shot Events" are shown, as long as they are pending.

Structure of the read data:

- Byte 0 contains 2 bit per IO-Link port which show, if the process data of the connected device are valid or not.
- 4 byte per diagnostic event, which assign and specify the diagnostics more precisely. A maximum of 14 Events per IO-Link port are shown.

Byte no.	Bit no.								Description
	7	6	5	4	3	2	1	0	
0								x	PD_Valid Input Port 1
							x		PD_Valid Output Port 1
						x			PD_Valid Input Port 2
					x				PD_Valid Output Port 2
				x					PD_Valid Input Port 3
			x						PD_Valid Output Port 3
		x							PD_Valid Input Port 4
	x								PD_Valid Output Port 4
1								x	PD_Valid Input Port 5
							x		PD_Valid Output Port 5
						x			PD_Valid Input Port 6
					x				PD_Valid Output Port 6
				x					PD_Valid Input Port 7
			x						PD_Valid Output Port 7
		x							PD_Valid Input Port 8
	x								PD_Valid Output Port 8
2	Qualifier								Defines the type of the event (Warning, Notification, Single Shot Event, etc.) in accordance with IO-Link specification "IO-Link Interface and System".
3	Port								
4	Event Code high byte								High or- low byte of the error code sent
5	Event Code low byte								
...	...								see byte 2 - 5
223	Qualifier								
224	Port								
225	Event Code high byte								
226	Event Code low byte								

Subindex 66: Set Default Parameterization

Writing this object sets the IO-Link master back to factory settings. Any parameter setting and configuration is overwritten. The data storage buffer is deleted as well.

Entity_Port	IO-Link sub index	Read/write	Length
0	66	Write	4 byte

Structure of the reset command:

Byte 3	Byte 2	Byte 1	Byte 0
0xEF	0xBE	0xAD	0xDE

Subindex 67: Teach Mode

The master reads all data (device-ID, vendor-ID, serial number, etc.) from the connected device and saves them. All all previously saved device data are overwritten.

Entity_Port	IO-Link sub index	Read/write	Length
0	67	Write	1 byte

Structure of the Teach command:

Byte 0	
0x00	Teach all ports
0x01	Teach port 1
0x02	Teach port 2
0x03	Teach port 3
0x04	Teach port 4
0x05	Teach port 5
0x06	Teach port 6
0x07	Teach port 7
0x08	Teach port 8
0x09...0xFF	Reserved

Subindex 68: Master Port Scan Configuration

The object reads the configuration of the IO-Link devices connected to the IO-Link master.

28 byte are returned per IO-Link port.

Entity_Port	IO-Link sub index	Read/write	Length
0	68	Read	Max. 244 byte

Structure of the response telegram:

IO-Link-port	Content	Length	Format	Description
Port 1	Vendor ID	2 byte	UINT16	Vendor ID of the connected device
	Device ID	4 byte	UINT32	Device ID of the connected device
	Function ID	2 byte	UINT16	Reserved
	Serial Number	16 byte	UINT8	Serial number of the connected device
	COM_Revision	1 byte	UINT8	IO-Link version
	Proc_In_Length	1 byte	UINT8	Process input data length of the connected device [▶ 182]
	Proc_Out_Length	1 byte	UINT8	Process output data length of the connected device [▶ 182]
	Cycle time	1 byte	UINT8	Cycle time of the connected device
Port 2... port 8	Structure similar to port 1			

Length of the process data from the connected IO-Link device

The structure of the input and output data is identical except for bit 6. The SIO bit is only contained in the process input data.

Bit 7	Bit 6	Bit 5	Bit 4	Bit 3	Bit 2	Bit 1	Bit 0
Reserved	SIO	BYTE	LENGTH				

Bit 6: SIO (only valid for process input data)

SIO	
0	SIO mode not supported
1	SIO mode supported by device

Bit 7 and bits 0...4 in combination provide information about the length of the process data.

BYTE	LENGTH	Meaning
0	0	No process data
0	1	1 bit process data
0	n (2...15)	n bit of process data, structured in bits
0	16	16 bit of process data, structured in bits
0	17...31	Reserved
1	0, 1	Reserved
1	2	3 byte, structured in bytes
1	n (3...30)	n + 1 byte, structured in bytes
1	31	32 byte, structured in bytes

Subindex 69: Extended Port Diagnostics

The object reads the Extended Port Diagnostics.

Entity_Port	IO-Link sub index	Read/write	Length
0	69	Read	Max. 120 byte

Structure of the Extended Port Diagnostics:

Byte no.	Bit no.							
	7	6	5	4	3	2	1	0
0	NO_SIO	TCYC	-	-	DS_F	NO_DS	-	-
1	-	WD	MD	PDI_H	-	-	NO_PD	-
2	-	-	-	-	-	-	-	-
3	Device status according to IO-Link specification							

Diagnostic bit	Meaning
NO_DS	The parameterized port mode does not support data storage. Remedy: <ul style="list-style-type: none"> ■ Change the parameterization of the port.
DS_F	Error in the data storage, synchronization not possible Possible causes: <ul style="list-style-type: none"> ■ Connected device does not support data storage ■ Overflow of the data storage buffer Remedy: <ul style="list-style-type: none"> ▶ Connect a device that supports data storage. ▶ Clear the data storage buffer. ▶ Deactivate the data storage.
TCYC	The device does not support the cycle time parameterized in the master. Remedy: <ul style="list-style-type: none"> ▶ Increase the cycle time set in the master.
NO_SIO	The device does not support the SIO mode. Remedy: <ul style="list-style-type: none"> ▶ Select the IO-Link mode for this port.
NO_PD	No process data available The connected device is not ready for operation. Remedy: <ul style="list-style-type: none"> ▶ Check the configuration.
PDI_E	The connected device reports invalid process data in accordance with IO-Link specification V1.0.
PDI_H	The connected device reports invalid process data in accordance with IO-Link specification V1.1.
MD	Missing device, no IO-Link device detected. Remedy: <ul style="list-style-type: none"> ■ Check the IO-Link cable. ■ Change the device.
WD	Wrong device detected: one or more parameters of the connected device (Vendor ID, Device ID, serial number) does not/do not match the data which are stored in the master for this device. Remedy: <ul style="list-style-type: none"> ■ Change the device. ■ Adapt the master parameterization.

Device Status

Value	Meaning
0	Device works correctly
1	Maintenance Event
2	Out-of-Specification Event
3	Functional check
4	Error
5...255	Reserved

8.3 Parameterizing IO-Link devices (IO-Link Device Application)

The parameter settings made in the IO-Link device using the on the IO-Link Device Application are saved in the device and, depending on the setting of the master parameter "Data storage mode" [▶ 173], can be saved in the IO-Link master and written to a new IO-Link device in the event of a device replacement.



NOTE

If IO-Link devices are configured and parameterized in PROFINET via SIDI (Simple IO-Link Device Integration) in the PLC, all parameter changes via the IO Configurator are temporary and are overwritten by the IO-Link device parameter set from the PLC on restart.

Parameterizing an IO-Link device



NOTE

To be able to call up the IO-Link Device Application, a login to the web server of the IO-Link master is required [▶ 36].

- ▶ Change **parameters** as required. Changed parameter settings are marked accordingly.
- ▶ Write changed parameters to the IO-Link device via **Write**.

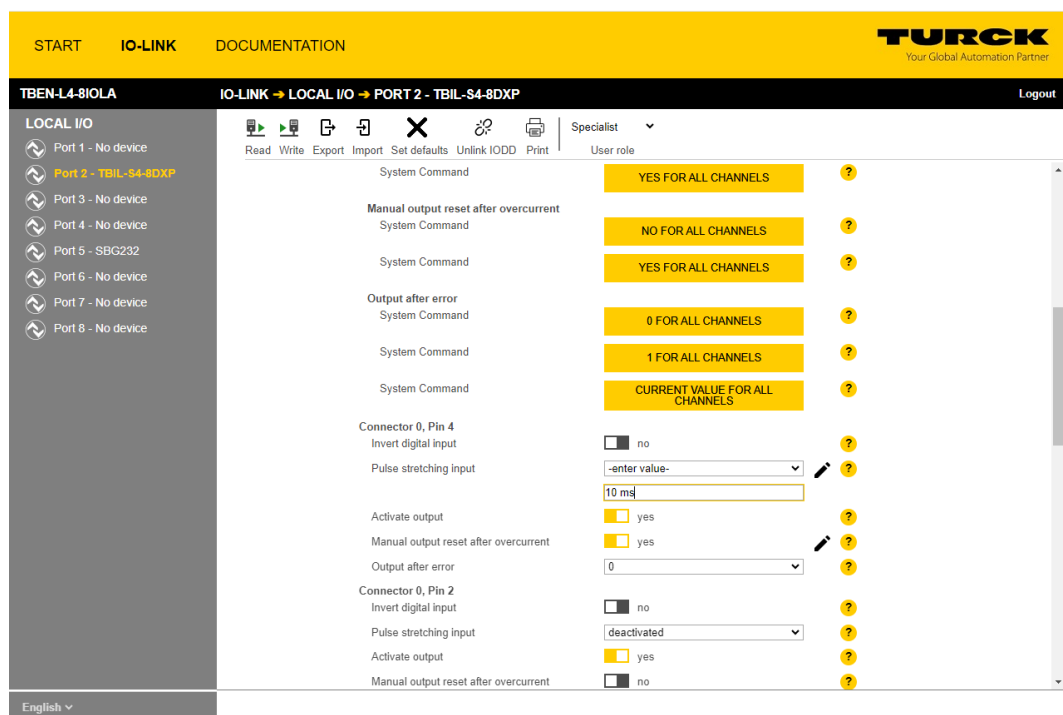

Fig. 101: Parameterizing an IO-Link device

Set defaults resets all device parameters to the default values defined in the IODD.

The parameter set of the IO-Link device can be exported or imported using the **Export** and **Import** functions.

9 Operating



CAUTION

Hot surface at full load and high ambient temperatures
Burn risk

► Avoid touching the device without additional protection.

9.1 Process input data

Word no.	Bit no.															
	15	14	13	12	11	10	9	8	7	6	5	4	3	2	1	0
Basic																
0x00	-	DI14 (SIO)	-	DI12 (SIO)	-	DI10 (SIO)	-	DI8 (SIO)	DXP7	DI6 (SIO)	DXP5	DI4 (SIO)	DXP3	DI2 (SIO)	DXP1	DI0 (SIO)
0x01	-	DVS 14	-	DVS 12	-	DVS 10	-	DVS8	-	DVS6	-	DVS4	-	DVS2	-	DVS0
IO-Link process input data																
0x02... 0x11	IO-Link port 1, structure depends on the channel parameterization (0...32 byte per channel)															
0x12... 0x21	IO-Link port 2, structure depends on the channel parameterization (0...32 byte per channel)															
0x22... 0x31	IO-Link port 3, structure depends on the channel parameterization (0...32 byte per channel)															
0x32... 0x41	IO-Link port 4, structure depends on the channel parameterization (0...32 byte per channel)															
0x42... 0x51	IO-Link port 5, structure depends on the channel parameterization (0...32 byte per channel)															
0x52... 0x61	IO-Link port 6, structure depends on the channel parameterization (0...32 byte per channel)															
0x62... 0x71	IO-Link port 7, structure depends on the channel parameterization (0...32 byte per channel)															
0x72... 0x81	IO-Link port 8, structure depends on the channel parameterization (0...32 byte per channel)															
Diagnostics																
VAUX1/VAUX2																
0x82	VERR V2 C7 ch15	VERR V2 C6 ch13	VERR V2 C5 ch11	VERR V2 C4 ch9	-	-	-	-	VERR V1 C7 ch14	VERR V1 C6 ch12	VERR V1 C5 ch10	VERR V1 C4 ch8	VERR V1 C3 ch6/7	VERR V1 C2 ch4/5	VERR V1 C1 ch2/3	VERR V1 C0 ch0/1
DXP channels																
0x83	-	-	-	-	-	-	-	-	ERR DXP 7	-	ERR DXP 5	-	ERR DXP 3	-	ERR DXP 1	-
IO-Link port 1																
0x84	GEN-ERR	OVL	V HIGH	V LOW	UL VE	LL VU	O TMP	PRM ERR	EVT2	EVT1	PD INV	HW ERR	DS ERR	CFG ERR	PPE	-
0x85	IO-Link port 2, assignment similar to port 1															
0x86	IO-Link port 3, assignment similar to port 1															
0x87	IO-Link port 4, assignment similar to port 1															

Word no.	Bit no.															
	15	14	13	12	11	10	9	8	7	6	5	4	3	2	1	0
0x88	IO-Link port 5, assignment similar to port 1															
0x89	IO-Link port 6, assignment similar to port 1															
0x8A	IO-Link port 7, assignment similar to port 1															
0x8B	IO-Link port 8, assignment similar to port 1															
IO-Link Events																
0x8C	Port (1st Event)								Qualifier (1st Event)							
0x8D	Event Code low byte (1st Event)								Event Code high byte (1st Event)							
...																
0xAA	Port 16th Event)								Qualifier (16th Event)							
0xAB	Event Code low byte (16th Event)								Event Code high byte (16th Event)							
Module status (status word)																
0xAC	-	FCE	-	-	-	COM	V1	-	V2	-	-	-	-	-	AR	DIAG
															GEE	

Meaning of the process data bits

Name	Value	Meaning
I/O data		
DI...		Digital input
	0	No signal at DI (pin 4, SIO)
	1	Signal at DI (pin 4, SIO)
DXP...		Configurable digital channel (DXP channel)
	0	No input signal at DXP channel (pin 2)
	1	Input signal at DXP channel (pin 2)
DVS...		Input value valid (Data Valid Signal)
	0	The IO-Link data are invalid. Possible causes: <ul style="list-style-type: none"> ■ Sensor supply below the admissible range. ■ IO-Link port parameterized as simple digital input. ■ No IO-Link device connected to the master. ■ No input data received from the connected device (only valid for devices with an input data length > 0). ■ No reaction from the connected device to the sending of output data (only valid for devices with an output data length > 0). ■ The connected device sends an Process input data invalid error.
	1	The IO-Link data are valid.
IO-Link process input data		Process input data of the connected IO-Link device The order of the IO-Link process input data can be changed via the parameter " Process input data mapping ".
Diagnostics		[▶ 192]
IO-Link Events		[▶ 180]
Module status		[▶ 192]

9.2 Process output data

Word no.	Bit no.															
	15	14	13	12	11	10	9	8	7	6	5	4	3	2	1	0
Basic																
0x00	-	DD 14	-	DD 12	-	DD 10	-	DD 8	DXP7	DD6	DXP5	DD4	DXP3	DD2	DXP1	DD0
IO-Link process output data																
0x01 ... 0x10	IO-Link port 1, structure depends on the channel parameterization (0...32 byte per channel)															
0x11 ... 0x20	IO-Link port 2, structure depends on the channel parameterization (0...32 byte per channel)															
0x21 ... 0x30	IO-Link port 3, structure depends on the channel parameterization (0...32 byte per channel)															
0x31 ... 0x40	IO-Link port 4, structure depends on the channel parameterization (0...32 byte per channel)															
0x41 ... 0x50	IO-Link port 5, structure depends on the channel parameterization (0...32 byte per channel)															
0x51 ... 0x60	IO-Link port 6, structure depends on the channel parameterization (0...32 byte per channel)															
0x61 ... 0x70	IO-Link port 7, structure depends on the channel parameterization (0...32 byte per channel)															
0x71 ... 0x80	IO-Link port 8, structure depends on the channel parameterization (0...32 byte per channel)															
VAUX1/VAUX2																
0x81	VAUX2 pin2 C7 (ch15)	VAUX 2 pin2 C6 (ch13)	VAUX 2 pin2 C5 (ch11)	VAUX 2 pin2 C4 (ch9)	-	-	-	-	VAUX 1 pin1 C7 (ch14)	VAUX 1 pin1 C6 (ch12)	VAUX 1 pin1 C5 (ch10)	VAUX 1 pin1 C4 (ch8)	VAUX1 pin1 C3 (ch6/7)	VAUX1 pin1 C2 (ch4/5)	VAUX1 pin1 C1 (ch2/3)	VAUX1 pin1 C0 (ch0/1)

Meaning of the process data bits

Name	Value	Meaning
I/O data		
DXPx	DXP output	
	0	Output inactive
	1	Output active, max. output current 2 A
DDx	Deactivate diagnostics	
	0	Diagnostic messages are sent depending on the setting of the "Deactivate diagnostics" parameter [▶ 174].
	1	All diagnostic messages are suppressed. Possible application: Controlled deactivation and activation of the diagnostic messages via the process data in the PLC program. In the case of tool change applications, no diagnostics are sent that would otherwise lead to system downtimes.
VAUX1 pin1 Cx (ch.../ ch...)	0	The 24 VDC sensor/actuator supply at pin 1 of the connector is switched off.
	1	The 24 VDC sensor/actuator supply at pin 1 of the connector is switched on.
VAUX2 pin2 Cx (ch.../ ch...)	0	The Class B supply at pin2 of the connector is switched off.
	1	The Class B supply at pin 2 of the connector is switched on.

9.3 LED displays

The device is provided with the following LEDs:

- Power supply voltage
- Group and bus error
- Status
- Diagnostics

LED PWR	Meaning
Off	No voltage connected or under voltage at V1
Green	Voltage V1 and V2 OK
Green flashing	No voltage or under voltage at V2 (depending on the configuration of the parameter LED behavior (PWR) at V2 undervoltage)
Red	

BUS LED	Meaning
Off	No voltage present
Green	Connection to a master active
Flashing 3 × green in 2 s	ARGEE active
Green flashing (1 Hz)	Device is operational
Red	IP address conflict, Restore mode active, F_Reset active or Modbus connection timeout
Red flashing	Wink command active
Red/green (1 Hz)	Autonegotiation and/or wait for IP address allocation in DHCP or BootIP mode

ERR LED	Meaning
Off	No voltage present
Green	No diagnostics
Red	Diagnostics present

ETH1 and ETH2 LEDs	Meaning
Off	No Ethernet connection
Green	Ethernet connection established, 100 Mbit/s
Green flashing	Data transfer, 100 Mbit/s
Yellow	Ethernet connection established, 10 Mbit/s
Yellow flashing	Data transfer, 10 Mbit/s

LED IOL 0, 2, 4, 6, 8, 10, 12, 14 (IO-Link port 1...8)		Meaning (Channel in IO-Link-mode)
Off		Port inactive, no IO-Link communication, diagnostics deactivated
Green flashing		IO-Link communication, process data valid
Red flashing		IO-Link communication active and module error, invalid process data
Red		IO-Link supply error free, no IO-Link communication and/ or module error, process data invalid

LED IOL 0, 2, 4, 6, 8, 10, 12, 14 (IO-Link port 1...8)		Meaning (channel in SIO mode (DI))
Off		No input signal
Green		Digital input signal active

LED IOL 9, 11, 13, 15 (IO-Link Class B ports 5...8)		Meaning
Off		VAUX2 at pin 2 inactive
Green		VAUX2 at pin 2 active
Red		VAUX2 at pin 2 active, overload/short-circuit at VAUX2
Red flashing		Overcurrent supply VAUX1

LED DXP 1, 3, 5, 7	Meaning (input)	Meaning (output)
Off	No input signal	Output inactive or V2 under-voltage
Green	Input signal present	Output active (max. 2 A)
Red	–	Output active with overload/short circuit
Red flashing	Overload supply VAUX1 both connector LEDs are flashing	

LED WINK (without designation on the device)		Meaning
White flashing		Wink command active

9.4 Software diagnostic messages

The device provides the following software diagnostic messages:

- V1/V2 overcurrent diagnostics
Overcurrent diagnostics for the sensor-/ actuator supply VAUX1 and the Class B supply VAUX2
- DSP diagnostics
Diagnostic messages of the universal digital channels of the module (DXP 1, 3, 5, 7).
- IO-Link master diagnostics
The IO-Link-master reports problems within the IO-Link communication.
- IO-Link device diagnostics
The device diagnostics map the IO-Link Event Codes (according to the IO-Link specification) sent from the IO-Link devices to the diagnostic telegram of the master.
Event Codes can be read from the connected devices by using appropriate device tools (e.g. IODD-Interpreter).
Further information concerning the IO-Link Event Codes and their meaning can be found in the IO-Link specification or in the documentation of the connected devices.

9.4.1 Status- and control word

Status word

EtherNet/IP/ Modbus	PROFINET	Bit 7	Bit 6	Bit 5	Bit 4	Bit 3	Bit 2	Bit 1	Bit 0
Byte 0	Byte 1	V2	-	-	-	-	-	ARGEE	DIAG
Byte 1	Byte 0	-	FCE	-	-	-	COM	V1	-

Bit	Description
ARGEE	ARGEE program running
COM	Internal error The device-internal communication is disturbed.
DIAG	Diagnostic messages at the device
FCE	The DTM Force Mode is activated. The actual output values may no match the ones defined and sent by the fieldbus.
V1	Undervoltage at supply voltage V1 (threshold, s. technical data), DXP channels switch off
V2	Undervoltage at supply voltage V2 (threshold, s. technical data),

The status word is mapped into the module's process data.

In EtherNet/IP the mapping can be deactivated via the Gateway Class (VSC 100).



NOTE

Activating or deactivating the status and control word modifies the process data mapping in den standard Assembly Instances 103 and 104 [► 86].

Control word

The control word has no function.

9.4.2 Diagnostic telegram

Channel	Byte no.	Bit 7	Bit 6	Bit 5	Bit 4	Bit 3	Bit 2	Bit 1	Bit 0
V1/V2		V1/V2 overcurrent diagnostics							
	0	VERR V1 C7 ch14	VERR V1 C6 ch12	VERR V1 C5 ch10	VERR V1 C4 ch8	VERR V1 C3 ch6/7	VERR V1 C2 ch4/5	VERR V1 C1 ch2/3	VERR V1 C0 ch0/1
	1	VERR V 2 C7 ch15	VERR V2 C6 ch13	VERR V2 C5 ch11	VERR V2 C4 ch9	-	-	-	-
DXP		DXP diagnostics							
	0	ERR DXP7	-	ERR DXP5	-	ERR DXP3	-	ERR DXP1	-
	1	-	-	-	-	-	-	-	-
IO-Link		Device diagnostic messages				Master diagnostics			
IO-Link port 1	0	EVT2	EVT1	PD INV	HW_ ERR	DS ERR	CFG ERR	PPE	-
	1	GEN ERR	OLV	VHIGH	VLOW	ULVE	LLVU	OTEMP	PRM ERR
IO-Link port 2	2...3	Assignment similar to IO-Link port 1							
...	...								
IO-Link port 8	14...15								



NOTE

The "process data" invalid diagnostic (PDINV) can be sent from both devices, IO-Link master or IO-Link device.

Meaning of diagnostic Bits

Bit	Meaning
V1/V2 overcurrent diagnostics	
VERRV1 Cx	Overcurrent VAUX1 (pin 1) at connector/channel group ch.../ch...
VERRV1 Cxch...	Overcurrent VAUX1 (pin 1) at connector/channel Cxch...
VERRV2 Cxch...	Overcurrent VAUX2 (pin 2) at connector/channel Cxch...
DXP diagnostics	
ERR_DXPx	Overcurrent at the output (if the DXP channel is used as output)
IO-Link master diagnostics	
CFGER	Wrong or missing device The connected device does not match the channel configuration or there is no device connected to the channel. This diagnostic message depends on the parameterization of the channel.

Bit	Meaning
DSER	<p>Data storage error</p> <p>Possible causes:</p> <ul style="list-style-type: none"> ■ Data storage mismatch: IO-Link device in accordance with IO-Link V1.0 connected. The data storage buffer contains data of another device. ■ Overflow of the data storage buffer ■ The connected device may be locked for parameter changes or for data storage.
PPE	<p>Port parameterization</p> <p>The port parameters are inconsistent. The device parameterization via GSD is active, but not working.</p> <p>Possible causes:</p> <ul style="list-style-type: none"> ■ The IO-Link-master did not receive GSDML-parameters for a connected device. The connected device was not parameterized by a PROFINET PLC via GSDML. ■ The port is in operation mode "IO-Link without validation" or "DI". These modes do not allow parameterization via GSDL file. ■ Data storage mode is active. The parameter is not set to "deactivated, clear". A device parameterization via GSDML is not possible with activated data storage. ■ Vendor or Device ID are "0". The connected device can not be identified and is thus not parameterizable.
IO-Link master/device diagnostics	
PDINV	<p>Evaluating Process Input Data</p> <p>The IO-Link master or the IO-Link device report invalid process input data. The connected device is not in status "operate", which means, it is not ready for operation.</p> <p>Possible sources:</p> <ul style="list-style-type: none"> ■ The connected device does not match the configured one, additional diagnostic message Wrong or missing device. ■ Diagnostic message Process input data invalid because the process value can not be measured (depends on the IO-Link device).
IO-Link device diagnostics	
	<p>The IO-Link device diagnostics depend on the IO-Link device used. For more detailed information on the diagnoses, please refer to the documentation for the IO-Link device.</p>
EVT1	<p>Maintenance events</p> <p>A Maintenance Event in accordance with the IO-Link specification occurred, maintenance necessary.</p>
EVT2	<p>Out-of-specification events</p> <p>An Out-of-Specification Event in accordance with the IO-Link specification occurred.</p>
GENERR	<p>Common error</p> <p>The device sends an error (device status 4, in accordance with IO-Link specification), which is not clearly specified. Read out the device Event Codes in order to be able to specify the error more precisely.</p>
HWER	<p>Hardware error</p> <p>General hardware error or device malfunction of the connected device</p>
LLVU	<p>Lower limit value underrun</p> <p>The process value lies under the parameterized measurement range or the chosen measurement range has been chosen too high.</p>

Bit	Meaning
OLV	Overload The connected device detected an overload.
OTMP	Overtemperature A temperature diagnosis is available on the connected device.
PRMERR	Parameterization error The connected device reports a parameterization error (loss of parameters, no parameter initialization, etc.).
ULVE	Upper limit value exceeded The process value exceeds the parameterized measurement range or the chosen measurement range has been chosen too low.
VLOW	Undervoltage One of the voltages at the connected device is below the defined range.
VHIGH	Overvoltage One of the voltages at the connected device exceeds the defined range.

9.4.3 PROFINET diagnostics

Module diagnostics (slot 0 according to configuration tool)		PROFINET Diagnostics	
	Connector	Error code	Channel
Undervoltage V1	-	0x0002	0
Undervoltage V2	-	0x0002	1

DXP diagnostics (slot 1 according to configuration tool)		PROFINET Diagnostics		
	Channel	Connector	Error code	Channel
Overcurrent output	DXP1	C0	0x0001	1
	DXP3	C1	0x0001	3
	DXP5	C2	0x0001	5
	DXP7	C3	0x0001	7

VAUX1/VAUX2 diagnostics (slot 1, according to configuration tool)		PROFINET Diagnostics	
		Error code	Channel
Overcurrent VAUX1 (pin 1) at C0, channel 0/1		0x01D0	0
Overcurrent VAUX1 (pin 1) at C1, channel 2/3		0x01D1	
Overcurrent VAUX1 (pin 1) at C2, channel 4/5		0x01D2	
Overcurrent VAUX1 (pin 1) at C3, channel 6/7		0x01D3	
Overcurrent VAUX1 (pin 1) at C4, channel 8		0x01E8	
Overcurrent VAUX1 (pin 1) at C5, channel 10		0x01EA	
Overcurrent VAUX1 (pin 1) at C6, channel 12		0x01EC	
Overcurrent VAUX1 (pin 1) at C7, channel 14		0x01EE	
Overcurrent VAUX2 (pin2) at C4, channel 9		0x01F9	
Overcurrent VAUX2 (pin2) at C5, channel 12		0x01FB	
Overcurrent VAUX2 (pin2) at C6, channel 14		0x01FD	
Overcurrent VAUX2 (pin2) at C7, channel 9		0x01FF	

IO-Link port diagnostics		PROFINET Diagnostics	
IO-Link port 1 (Slot 2, according to configuration tool)	Connector	Error code	Channel
Undervoltage (VLOW)	C0	0x0002	0
Overcurrent (VHIGH)		0x0003	
Overload (OVL)		0x0004	
Over temperature (OTMP)		0x0005	
Wrong or missing device (CFGERR)		0x0006	
Upper limit value exceeded (ULVE)		0x0007	
Lower limit value underrun (LLVU)		0x0008	
Data storage error (DSER)		0x0009	
Process input data invalid (PDINV)			
Maintenance events (EVT1)			
Out of specification error (EVT2)			
Port parameterization error (PPE)			
Parameterization error (PRMER)			
Hardware error (HWERR)		0x0010	
IO-Link port 2 (Slot 3, according to configuration tool)			
Similar to port 1	C1		2
IO-Link port 3 (Slot 4, according to configuration tool)			
Similar to port 1	C2		4
IO-Link port 4 (Slot 5, according to configuration tool)			
Similar to port 1	C3		6
IO-Link port 5 (Slot 6, according to configuration tool)			
Similar to port 1	C4		8
IO-Link port 6 (Slot 7, according to configuration tool)			
Similar to port 1	C5		10
IO-Link port 7 (Slot 8, according to configuration tool)			
Similar to port 1	C6		12
IO-Link port 8 (Slot 9, according to configuration tool)			
Similar to port 1	C7		14

9.5 Using IO-Link data storage

IO-Link data storage is only possible if IO-Link devices connected to the IO-Link master are not parameterized by a controller (e.g., via a GSDML). This means that parameterization of IO-Link devices in PROFINET via SIDI (Simple IO-Link-Device-Integration [▶ 15]) excludes the use of data storage.

Data storage mode



NOTE

Data storage mode is only available for devices complying with the IO-Link specification V1.1. IO-Link devices in accordance with IO-Link specification V1.0 do not support data storage.

In the IO-Link master, the data storage mode can be set using the parameter "data storage mode".

- 0 = activated
- 1 = overwrite
- 2 = read in
- 3 = deactivated, clear

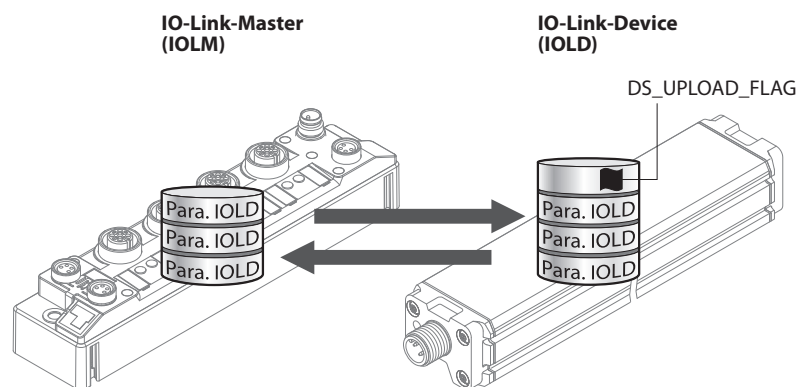

Fig. 102: Data storage mode – general principle, Para. IOLD = parameters of the IO-Link device

A change of parameters in the device is indicated by the status of the DS_UPLOAD_FLAG bit:

- 0 = no changes in the device's parameter set
- 1 = changes in the device's parameter set (e. g. via DTM, at the device, etc.)

9.5.1 Parameter "Data storage mode" = activated

The synchronization of the parameter sets is bidirectional.

The actual data set (master or device) is valid:

The following applies:

- The data set in the device is actual, if DS_UPLOAD_FLAG = 1.
- The data set in the Master is actual, if DS_UPLOAD_FLAG = 0.

Use Case 1: Parameterizing the Device using e.g. a DTM

- ✓ The IO-Link device is already installed in the system and connected to the master.
- ▶ Parameterizing the device via DTM.
- ⇒ DS_UPLOAD_FLAG = 1, parameter set in the device changed.
- ⇒ The parameter data are transferred from the new IO-Link device to the IO-Link master.

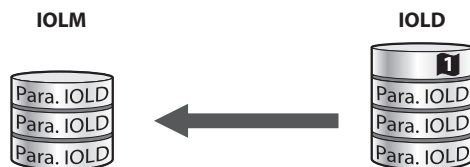

Fig. 103: Data storage mode activated – parameter set in the device changed

Use case 2: replace a defective device with a device in the delivery state.

- ✓ The **new** IO-Link device has **not** been connected to the master before.
- ▶ The parameters of the new device remain unchanged, DS_UPLOAD_FLAG = 0.
- ⇒ The parameter data of the defective device are transferred from the IO-Link master to the new IO-Link device.

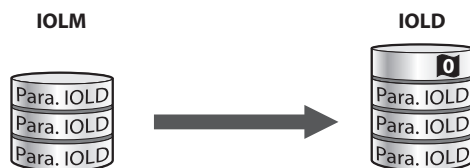

Fig. 104: Data storage mode activated – parameter set in the device unchanged

Use case 3: replace a defective device with a device with unknown (changed) parameters

- ✓ The **new** IO-Link device has **not** been connected to the master before.
- ▶ The parameters of the new device remain unchanged, DS_UPLOAD_FLAG = 1.
- ⇒ The parameter data are transferred from the new IO-Link device to the IO-Link master.

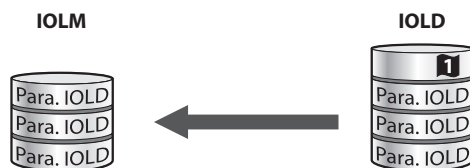

Fig. 105: Data storage mode activated – parameter set in the device changed



NOTE

If device replacement is necessary when data storage is activated, an IO-Link replacement device with unknown parameter data should be reset to its factory settings before connection to the IO-Link master.

Turck IO-Link devices can be reset to factory settings via a system command using a generic IO-Link DTM and the device specific IODD. For the reset of third party devices, please read the corresponding manufacturer documentation.

9.5.2 Parameter "Data storage mode" = read in

- The data set in the device is **always** the reference data set.
- The synchronization of the parameter sets is unidirectional towards to the master.
- The status of the DS_UPLOAD_FLAG is ignored.

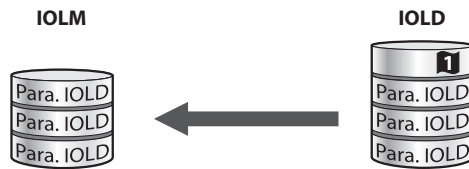

Fig. 106: Data storage mode = read in – parameter set in the device changed

9.5.3 Parameter "Data storage mode" = overwrite

- The data set in the master is **always** the reference data set.
- The synchronization of the parameter sets is unidirectional towards to the device.
- The status of the DS_UPLOAD_FLAG is ignored.

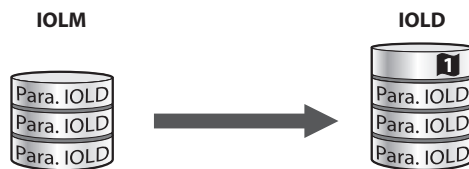

Fig. 107: Data storage mode = overwrite – parameter set in the master changed

9.5.4 Parameter "Data storage mode" = deactivated, clear

- The data set in the master is deleted.
- The synchronization of parameter sets is deactivated.



Fig. 108: Data storage mode deactivated – no synchronization

9.6 Operating IO-Link devices (IO-Link Device Application)

The IO-Link Device Application offers many functions for monitoring IO-Link devices during operation and for reading out and checking process data. The functions vary depending on the IO-Link device used and the associated IODD.

The **process data** currently present on the IO-Link is prepared and displayed according to the data structure of the IO-Link device. The chronological progression can be displayed using the chart function.

The screenshot shows the 'Process data' tab for a Turck DR15S-M30E-IOL8X2-H1141 device. The interface includes a sidebar with navigation options like 'LOCAL I/O', 'Identification', 'Parameters', 'Diagnostics', 'Observation', 'Process data', 'Process data structure', 'Radar monitor', 'Active events', and 'Event history'. The main content area displays the following process data:

Process data in	Value
Process Data (IN): Switching state of output 1	on
Process Data (IN): Switching state of output 2	on
Process Data (IN): Scaling exponent	-4
Process Data (IN): Process data	6352

Below the table is a 'Radar monitor' chart showing 'Out of range (-)' with a horizontal yellow line at the top of the plot area.

Fig. 109: Process data of an IO-Link device

Diagnostics present at the IO-Link device are displayed under **Diagnostics**.

The screenshot shows the 'Diagnostics' tab for the same Turck DR15S-M30E-IOL8X2-H1141 device. The 'Diagnostics' tab is selected in the sidebar. The main content area displays the following diagnostic information:

Diagnostic Item	Value	Status
Device Status	Failure	?
Detailed Device Status	Fault from Application (0x8ca3) The sensor was unable to perform autodetection at output 2.	?
Error Count	0	?
Operating hours	2064 h	?
Operating hours limit	1000000 h	?
Switching counter: Output 1	10089023	?
Switching counter: Output 2	25609	?
Switching counter limit: Output 1	1000000000	?
Switching counter limit: Output 2	1000000000	?
System Command	START BLINKING	
System Command	STOP BLINKING	
Extreme values		
Smallest distance	0.0 mm	?
System Command	RESET SMALLEST DISTANCE VALUE	
Largest distance	5110.2 mm	?
System Command	RESET LARGEST DISTANCE VALUE	

Fig. 110: Diagnostics at IO-Link device

Current IO-Link events are processed under **Active events** and displayed in plain text. The **Event history** provides past events.

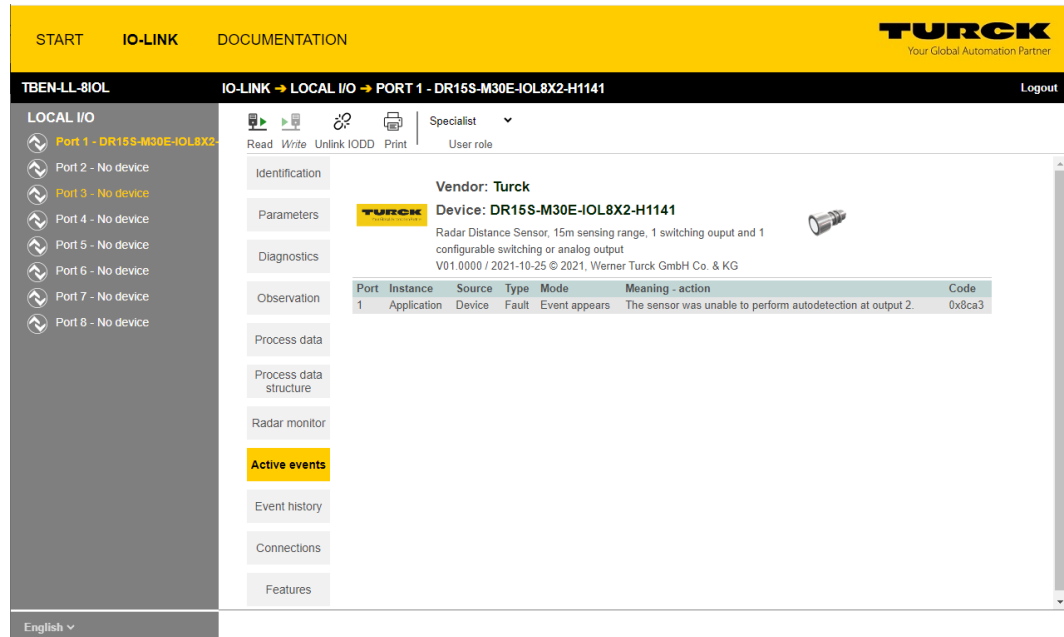

Fig. 111: Active events

In addition, the IO-Link Device Application offers the special functions of some sensors such as the **Radar monitor** for Turck radar sensors or the **Subsonic monitor** for Turck ultrasonic sensors.

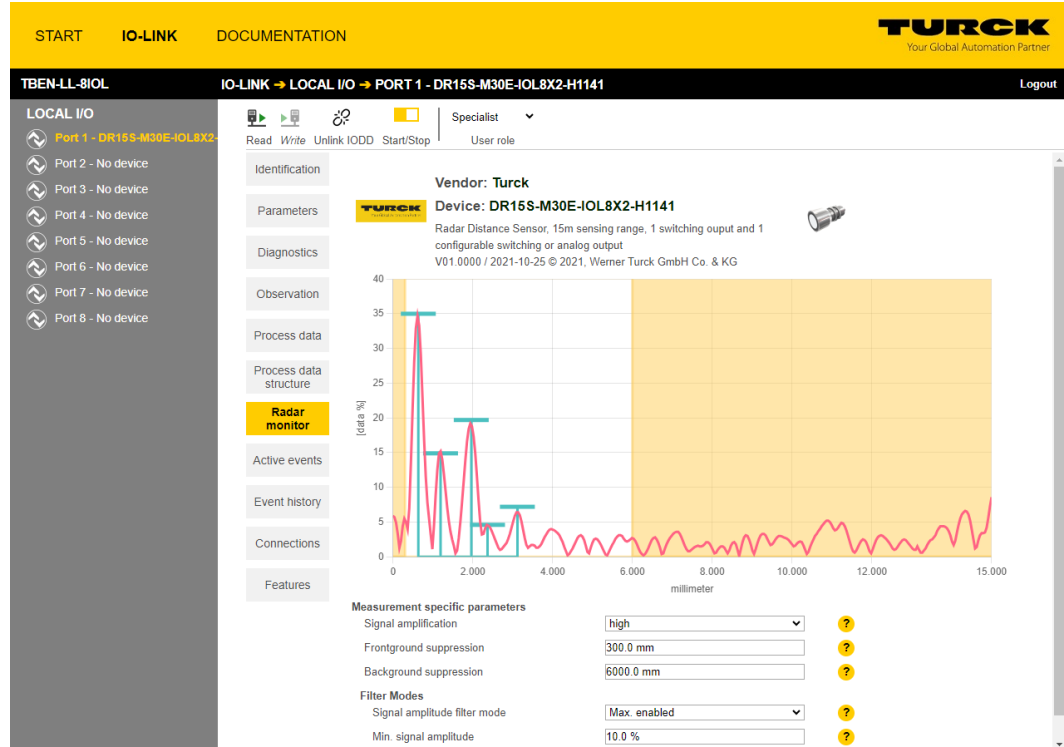

Fig. 112: Radar monitor

10 Troubleshooting

If the device does not work as expected, proceed as follows:

- ▶ Exclude environmental disturbances.
- ▶ Check the connections of the device for errors.
- ▶ Check device for parameterization errors.

If the malfunction persists, the device is faulty. In this case, decommission the device and replace it with a new device of the same type.

10.1 Eliminate parameterization errors in the IO-Link master

DXP channels

Error	Possible causes	Measure
DXP output not switching	The output is deactivated in the default setting of the device.	▶ Activate the output function via the Activate output parameter (DXP_EN_DO = 1).

IO-Link channels

LED behavior	Diagnostics	Possible causes:	Remedy
LED ERR constant red, LED IOL red flashing	Data storage error	IO-Link device according to IO-Link V1.0 connected IO-Link devices in accordance with IO-Link specification V1.0 do not support data storage.	▶ Set parameter Data storage mode to deactivated, clear . ⇒ Data storage remain deactivated.
		The data storage buffer contains data of another device.	▶ Set parameter Data storage mode to deactivated, clear . ▶ Re-activate the data storage if necessary.
	Wrong or missing device	The connected device does not match the configured one (wrong vendor-ID, device-ID etc.)	▶ Adapt the parameterization of the IO-Link port (Vendor ID, Device ID, etc.). The parameterization can be done manually via the web server, TAS or similar or by teaching the master using the IO-Link-Call (port 0 function, sub index 67: Teach mode).
Process input data invalid	Certain IO-Link devices send a process input data invalid diagnosis if the process value cannot be measured.	▶ Deactivate the sending of the diagnosis for the IO-Link port with the parameter Process input data invalid → No diagnostic generated .	

11 Maintenance

Ensure regularly that the plug connections and cables are in good condition.

The devices are maintenance-free, clean dry if required.

11.1 Updating the firmware via TAS



NOTICE

Interruption of the power supply during the firmware update

Risk of device damage due to faulty firmware update

- ▶ Do not interrupt the power supply during the firmware update.
- ▶ During the firmware update do not reset the power supply.
- ▶ Do not interrupt the Ethernet connection during the firmware update.



NOTE

The firmware update function in TAS is locked when the controller connection is active. The device must first be disconnected from the controller before performing the update.

Starting a firmware update for a device

- ▶ Open TAS.
- ▶ Open the network view.
- ▶ Select the device.
- ▶ Click **Firmware update**.

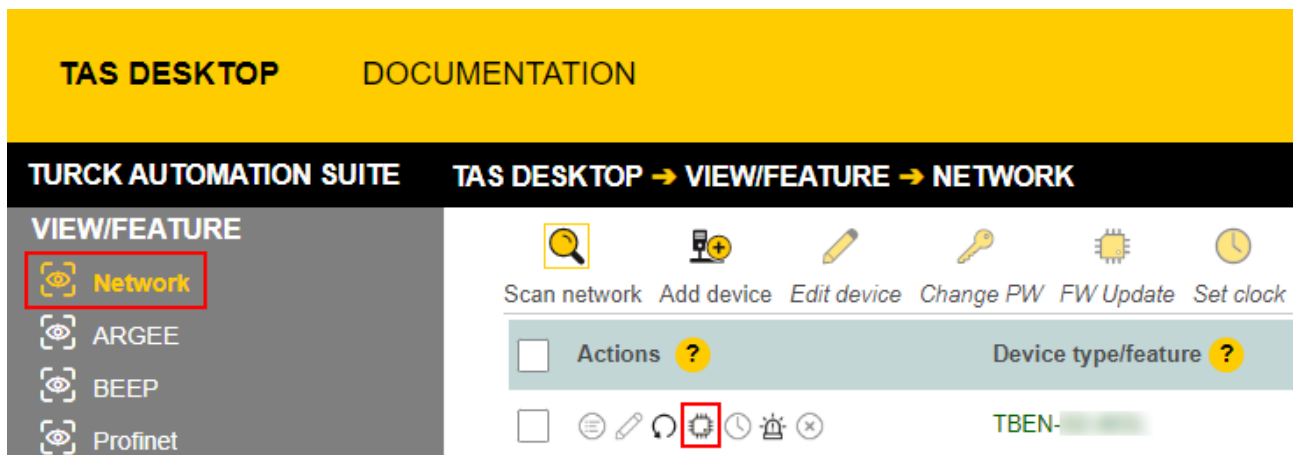

Fig. 113: Firmware update network view

As an alternative to selecting a single device, it is also possible to select multiple devices. To do so, all devices to be updated must correspond to the same device type and be in the same TCP network.

This enables a firmware update to be performed for multiple devices at once.

Starting a firmware update for multiple devices

- ▶ In the network view, check the box for all desired devices.
- ▶ Click **FW update** in the header.

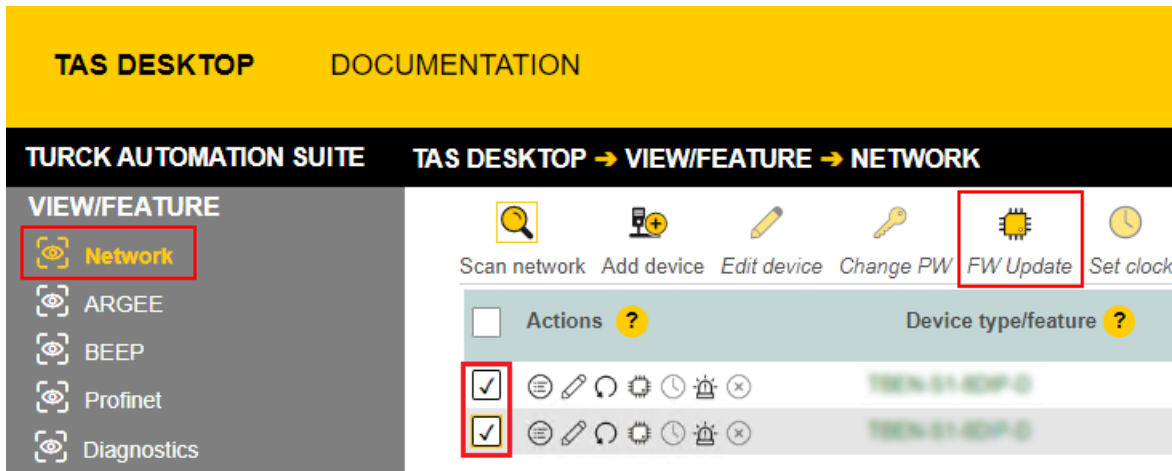

Fig. 114: Firmware update network view multiple devices



NOTE

For multiple devices of the same type, a global password can be set, which can be used to unlock all selected devices directly. This requires that all selected devices have the same device password and are in the same TCP network.

- ▶ Enter a global or device password. The default password is "password".
- ▶ Click **LOG IN**.
- ▶ Click **SELECT FILE**.
- ▶ Open the directory of the firmware file.
- ▶ Select a new firmware file and load it by clicking **Open**.
- ▶ Click **START** to start the firmware update.

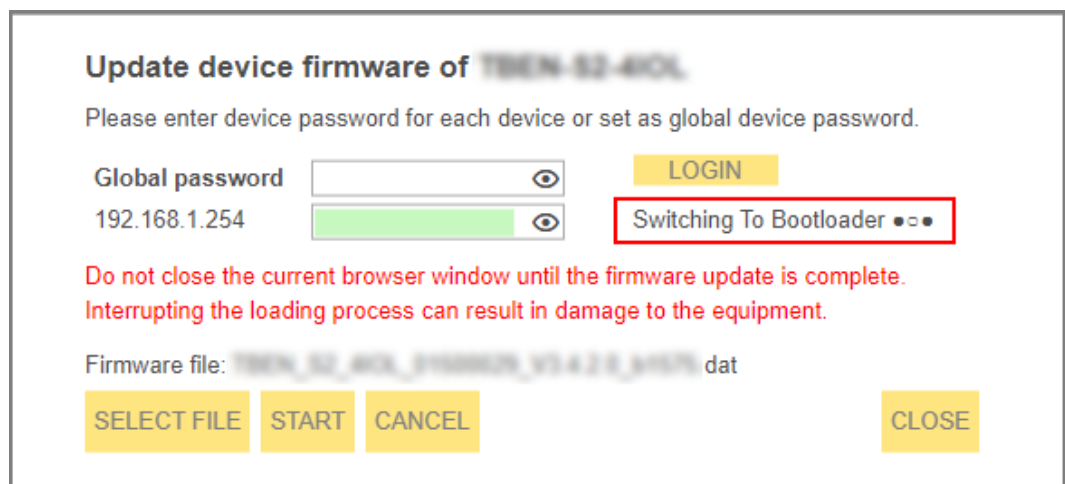

Fig. 115: Firmware update progress

- ⇒ The progress of the firmware update is displayed.

11.2 Updating the firmware via web server



NOTICE

Interruption of the power supply during the firmware update

Risk of device damage due to faulty firmware update

- ▶ Do not interrupt the power supply during the firmware update.
- ▶ During the firmware update do not reset the power supply.
- ▶ Do not interrupt the Ethernet connection during the firmware update.

- ▶ Open the web server.
- ▶ Log on to the device as administrator. The default password for the web server is "password".
- ▶ Click **Firmware** → **SELECT FIRMWARE FILE**.
- ▶ Select the new firmware file and load it via **Open**.

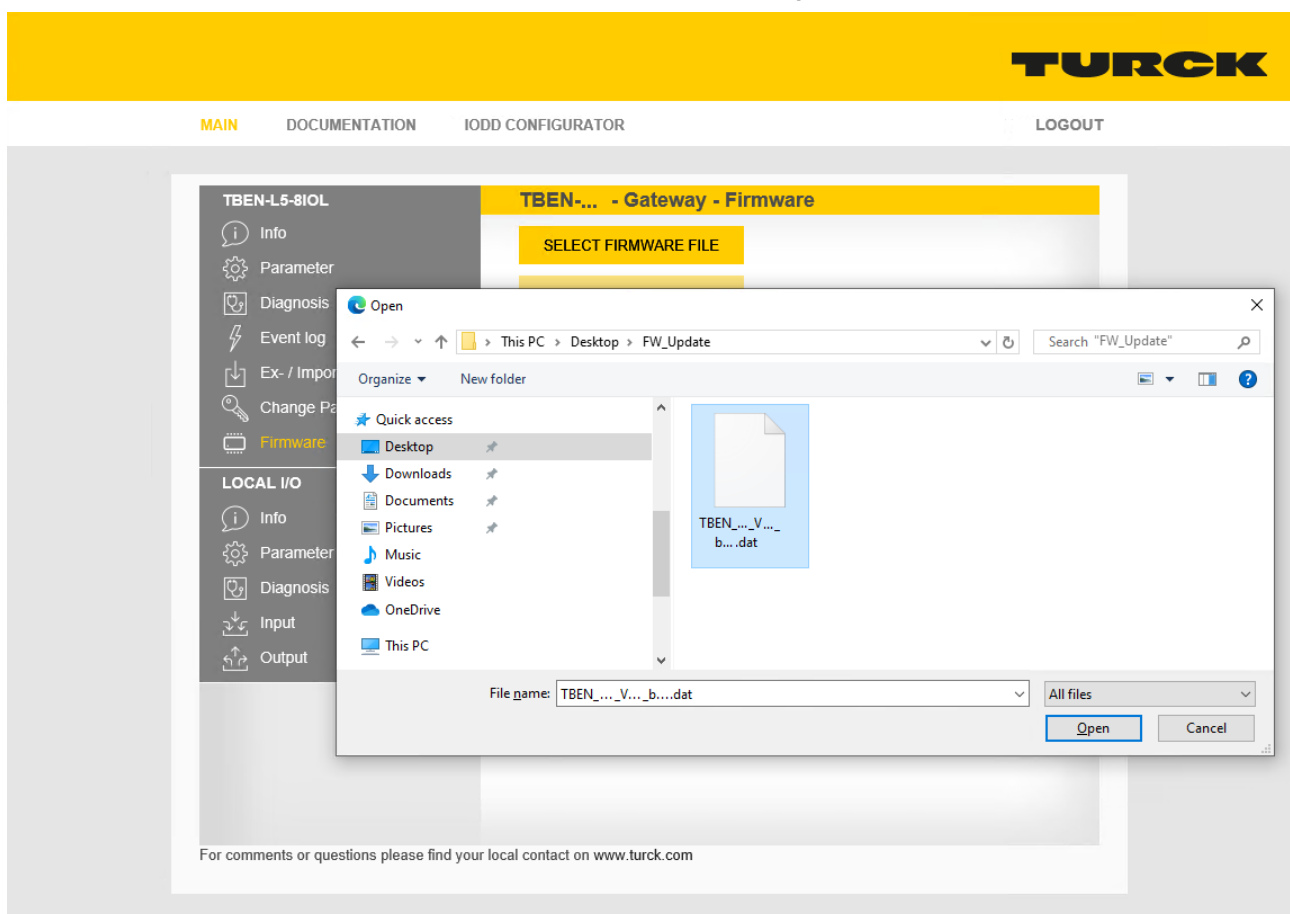

Fig. 116: Webserver – Selecting the firmware file

- ▶ Click **Update Firmware** and start the update.

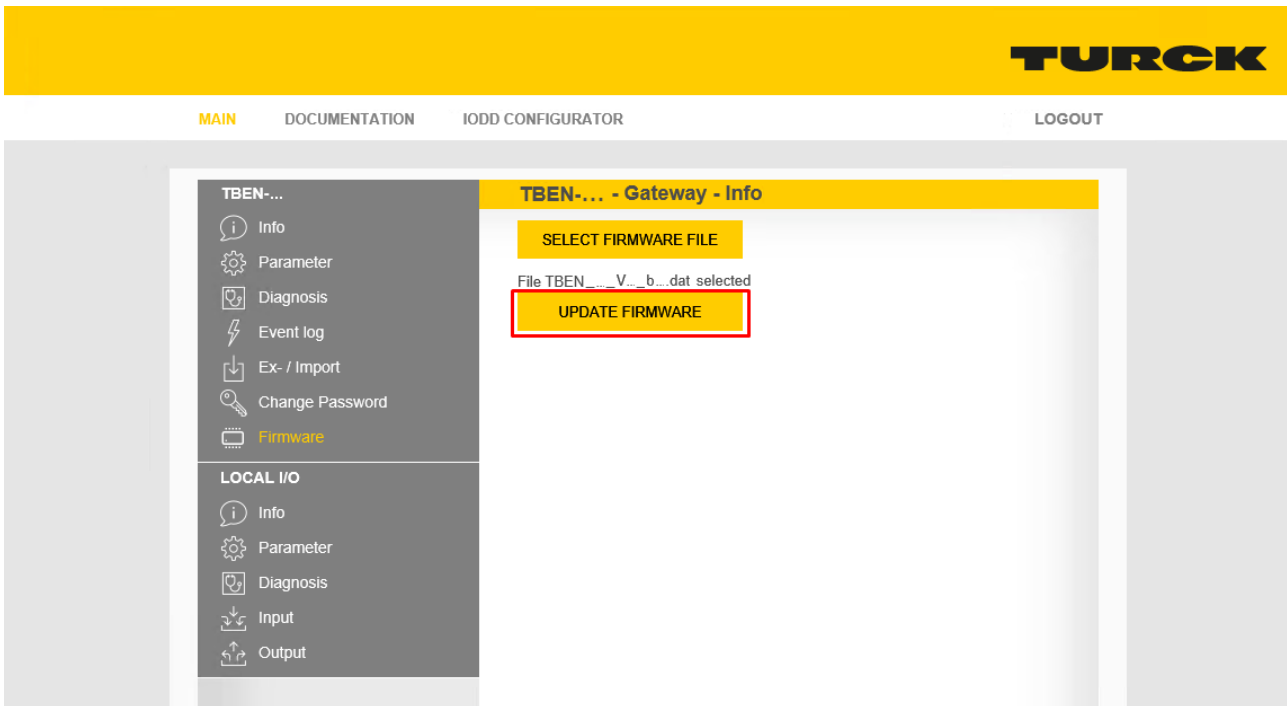

Fig. 117: Webserver – Starting the firmware update

- ⇒ The progress of the firmware update is displayed.

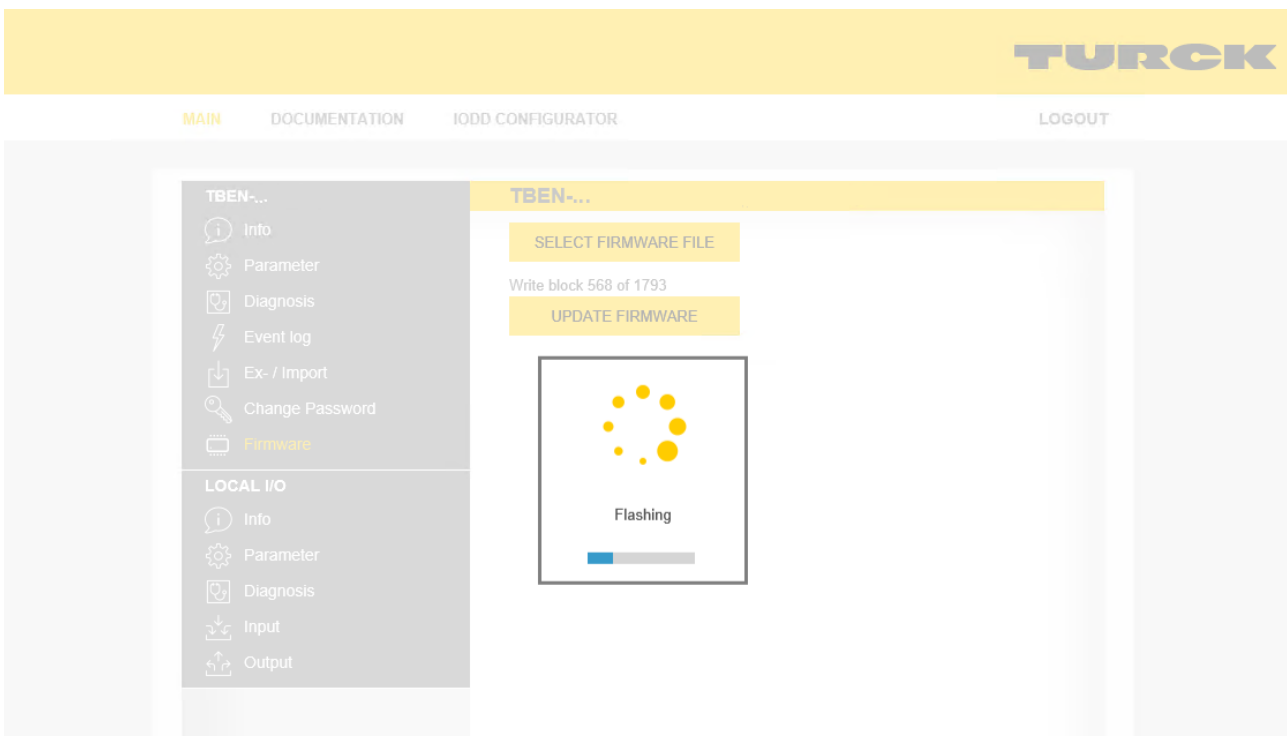

Fig. 118: Webserver – Firmware update running

- ▶ Restart the device after the update process has been completed.

12 Repair

The device is not intended for repair by the user. The device must be decommissioned if it is faulty. Observe our return acceptance conditions when returning the device to Turck.

12.1 Returning devices

If a device has to be returned, bear in mind that only devices with a decontamination declaration will be accepted. This is available for download at <https://www.turck.de/en/return-service-6079.php> and must be completely filled in, and affixed securely and weather-proof to the outside of the packaging.

13 Disposal



The devices must be disposed of properly and do not belong in the domestic waste.

14 Technical data

Technical data	
Supply	
Supply voltage	24 VDC
Permissible range	18...30 VDC
Total current	max. 9 A per voltage group V1 + V2: max. 11 A
Supply	
Threshold for undervoltage diagnostics V1 and V2 (if used in device)	18 V DC
■ Ex derating	S. document "Notes on Use in Ex zone 2 and 22" (ID 100022986)
Supply	
Threshold for undervoltage diagnostics V1 and V2 (if used in device)	18 V DC
Power consumption	
Operating current (at 24 VDC nominal voltage)	< 120 mA (outputs inactive)
Operating current (at 28,8...18,0 VDC)	<ul style="list-style-type: none"> ■ V1: 120...180 mA ■ V2: 90...40 mA Operating conditions: <ul style="list-style-type: none"> ■ All outputs active no load ■ Ethernet connection active
Sensor/actuator supply V_{AUX1}	Supply from V1, short-circuit proof, max. 4 A per connector C0 and C4, max. 2 A per connector C1...C3, C5...C7
Sensor/actuator supply V_{AUX2}	Class B supply from V2 short-circuit proof, max. 4 A per connector C4...C5 2 A per connector C6...C7
Potential isolation	Galvanic isolation from V1 and V2 voltage group, voltages up to 500 VDC
Connectors	
Ethernet	2 x M12, 4-pin, D coded
Power supply	
■ TBEN-L4-...	<ul style="list-style-type: none"> ■ X1: 7/8" male connector, 4-pin ■ X2: 7/8" female connector, 4-pin
■ TBEN-L5-...	<ul style="list-style-type: none"> ■ X1: 7/8" male connector, 5-pin ■ X2: 7/8" female connector, 5-pin
Digital in-/outputs	8x M12, 5-pin, A-coded
Permissible torques	
■ Ethernet	0.6 Nm
■ I/O channels/supply	0.8 Nm
■ Mounting (M6 screws)	1.5 Nm
Max. cable length	

Technical data	
■ Ethernet	100 m (per segment)
Isolation voltages	
V1 to V2	≥ 500 V AC
V1/V2 to fieldbus	≥ 500 V AC
System data	
Transmission rate	10 Mbps/100 Mbps
Protocol detection	Automatic
Web server	Integrated, 192.168.1.254
Service interface	Ethernet via P1 or P2
Field Logic Controller (FLC)	
Supported from firmware version	3.0.6.0
Released as of ARGEE version	2.0.25.0
Modbus TCP	
Address assignment	Static IP, DHCP
Supported Function Codes	FC3, FC4, FC6, FC16, FC23
Number of TCP connections	8
Input register start address	0 (0x0000)
Output register start address	2048 (0x0800)
Local port	Port 502, fix setting
EtherNet/IP	
Address assignment	According to EtherNet/IP standard
Device Level Ring (DLR)	Supported
Quick Connect (QC)	< 150 ms
Min. RPI (Requested Packet Interval)	2 ms
Number of Class 3 (TCP) connections	3
Number of Class 1 (CIP) connections	10
Input Assembly Instances	103, 120, 121, 122, 123, 124, 125
Output Assembly Instances	104, 150, 151, 152
Configuration Assembly Instances	106
PROFINET	
PROFINET specification	V 2.35
Conformance Class	B (RT)
Address assignment	DCP
MinCycle Time	1 ms
Fast Start Up (FSU)	< 150 ms
Diagnostics	According to PROFINET alarm handling
Topology detection	Supported
Automatic address setting	Supported
Media Redundancy Protocol (MRP)	Supported
System redundancy	S2
Network load class	3
Digital inputs	

Technical data	
No. of channels	4 DXP and 8 SIO
Input type	PNP
Type of input diagnostics	Channel diagnostics
Switching threshold	EN 61131-2 type 3, PNP
Signal voltage low level	< 5 V
Signal voltage high level	> 11 V
Signal current low level	< 1.5 mA
Signal current high level	> 2 mA
Max. input frequency	100 Hz (for fieldbus communication)
Input delay	0.05 ms
Potential isolation	Galvanic isolation to Ethernet, voltage proof up to 500 V AC
Digital outputs	
No. of channels	4 DXP
Output type	PNP
Type of output diagnostics	Channel diagnostics
Output voltage	24 VDC from potential group
Output current per channel	2 A, short-circuit-proof
Load type (UL)	Resistive, coil
Potential isolation	Galvanic isolation to Ethernet, voltage proof up to 500 V AC
IO-Link	
No. of channels	8
IO-Link	Pin 4 in IO-Link mode
IO-Link specification	Version 1.1
IO-Link port type	Class A at C0...C3 Class B at C4...C7
Frame type	Supports all specified frame types
Supported devices	Max. 32 byte input/32 byte output
■ Input data	■ Max. 32 byte per channel
■ Output data	■ Max. 32 byte per channel
Transmission rate	4.8 kbps (COM 1) 38.4 kbps (COM 2) 230.4 kbps (COM 3)
Transmission cable	Length: max. 20 m standard lines, 3- or 4-wire (depending on the application), unshielded
Mounting	

Technical data	
Type of mounting	Via 2 mounting holes, Ø 6.3 mm
Mounting distance (device to device)	<p>≥ 50 mm</p> <p>Valid for operation in the ambient temperatures mentioned below, with sufficient ventilation as well as maximum load (horizontal mounting).</p> <p>At ambient temperatures of < 30 °C, the devices can also be mounted directly next to each other.</p>
Standard/directive conformity	
Vibration test	According to EN 60068-2-6
Acceleration	Up to 20 g
Shock test	According to EN 60068-2-27
Drop and topple	According to IEC 60068-2-31/IEC 60068-2-32
Electromagnetic compatibility	According to EN 61131-2
Approvals and certificates	CE, FCC
UL cond.	cULus LISTED 21 W2, Encl.Type 1 IND.CONT.EQ.
General information	
Dimensions (w × l × h)	60.4 × 230.4 × 39 mm
Operating temperature	-40...+70 °C
Storage temperature	-40...+85 °C
Operating height	Max. 5000 m
Degree of protection	IP65/IP67/IP69K (not evaluated by UL)
MTTF	160 years acc. to SN 29500 (Ed. 99) 20 °C
Housing material	PA6-GF30
Housing color	Black
Material window	Lexan
Material label	Polycarbonate
Halogen free	Yes

Note on FCC



NOTE

This device complies with the limit values for a Class A digital device in accordance with Part 15 of the FCC regulations. Operation of this device in a residential area may cause harmful interference. In this case users must rectify the interference at their own cost.

15 Turck branches — contact data

Germany	Hans Turck GmbH & Co. KG Witzlebenstraße 7, 45472 Mülheim an der Ruhr www.turck.de
Australia	Turck Australia Pty Ltd Building 4, 19-25 Duerdin Street, Notting Hill, 3168 Victoria www.turck.com.au
Austria	Turck GmbH Graumanngasse 7/A5-1, A-1150 Vienna www.turck.at
Belgium	TURCK MULTIPROX Lion d'Orweg 12, B-9300 Aalst www.multiprox.be
Brazil	Turck do Brasil Automação Ltda. Rua Anjo Custódio Nr. 42, Jardim Anália Franco, CEP 03358-040 São Paulo www.turck.com.br
Canada	Turck Canada Inc. 140 Duffield Drive, CDN-Markham, Ontario L6G 1B5 www.turck.ca
China	Turck (Tianjin) Sensor Co. Ltd. 18,4th Xinghuazhi Road, Xiqing Economic Development Area, 300381 Tianjin www.turck.com.cn
Czech Republic	TURCK s.r.o. Na Brne 2065, CZ-500 06 Hradec Králové www.turck.cz
France	TURCK BANNER S.A.S. 11 rue de Courtalin Bat C, Magny Le Hongre, F-77703 MARNE LA VALLEE Cedex 4 www.turckbanner.fr
Hungary	TURCK Hungary kft. Árpád fejedelem útja 26-28., Óbuda Gate, 2. em., H-1023 Budapest www.turck.hu
India	TURCK India Automation Pvt. Ltd. 401-403 Aurum Avenue, Survey. No 109 /4, Near Cummins Complex, Baner-Balewadi Link Rd., 411045 Pune - Maharashtra www.turck.co.in
Italy	TURCK BANNER S.R.L. Via San Domenico 5, IT-20008 Bareggio (MI) www.turckbanner.it
Japan	TURCK Japan Corporation ISM Akihabara 1F, 1-24-2, Taito, Taito-ku, 110-0016 Tokyo www.turck.jp

Korea	Turck Korea Co, Ltd. A605, 43, Iljik-ro, Gwangmyeong-si 14353 Gyeonggi-do www.turck.kr
Malaysia	Turck Banner Malaysia Sdn Bhd Unit A-23A-08, Tower A, Pinnacle Petaling Jaya, Jalan Utara C, 46200 Petaling Jaya Selangor www.turckbanner.my
Mexico	Turck Comercial, S. de RL de CV Blvd. Campestre No. 100, Parque Industrial SERVER, C.P. 25350 Arteaga, Coahuila www.turck.com.mx
Netherlands	Turck B. V. Ruiterlaan 7, NL-8019 BN Zwolle www.turck.nl
Poland	TURCK sp.z.o.o. Wroclawska 115, PL-45-836 Opole www.turck.pl
Romania	Turck Automation Romania SRL Str. Siriului nr. 6-8, Sector 1, RO-014354 Bucuresti www.turck.ro
Sweden	Turck AB Fabriksstråket 9, 433 76 Jonsered www.turck.se
Singapore	TURCK BANNER Singapore Pte. Ltd. 25 International Business Park, #04-75/77 (West Wing) German Centre, 609916 Singapore www.turckbanner.sg
South Africa	Turck Banner (Pty) Ltd Boeing Road East, Bedfordview, ZA-2007 Johannesburg www.turckbanner.co.za
Turkey	Turck Otomasyon Ticaret Limited Sirketi Inönü mah. Kayisdagi c., Yesil Konak Evleri No: 178, A Blok D:4, 34755 Kadiköy/ Istanbul www.turck.com.tr
United Kingdom	TURCK BANNER LIMITED Blenheim House, Hurrricane Way, GB-SS11 8YT Wickford, Essex www.turckbanner.co.uk
USA	Turck Inc. 3000 Campus Drive, USA-MN 55441 Minneapolis www.turck.us

TURCK

Your Global Automation Partner



Over 30 subsidiaries and
60 representations worldwide!

D301407 | 2025/04



www.turck.com