

I/O Hub for connection of digital signals to IO-Link Master

8 Universal Digital Channels, PNP

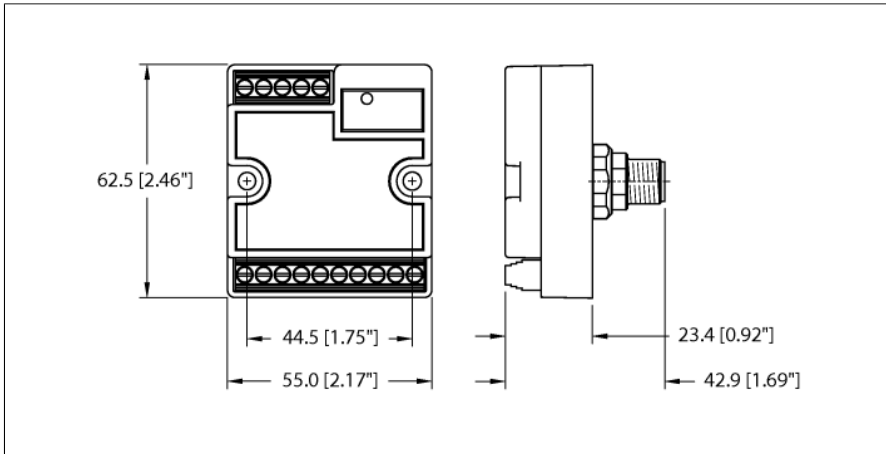



FIL20-8DXP-E

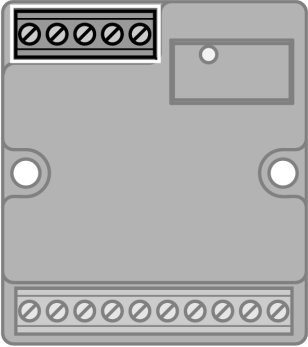

ID	100005647
Supply	
Supply voltage	24
Admissible range	18...30 VDC V1+ max. 4 A
System power supply	V1+
Voltage supply connection	Screw terminals
Operating current	120 mA
Sensor/actuator supply	Screw Terminal 10 supply from V1+, 0.7A max.
System data	
Fieldbus connection technology	Screw terminals
Terminal cross-section	0.2...1.5 mm ² (AWG: 26...14)
Tightening torque	0.5 Nm
Digital inputs	
Number of channels	8
Connectivity inputs	Screw terminals
Type of input diagnostics	Channel diagnostics
Low-level signal voltage	-3...5 VDC (EN 61131-2, type 1 and 3)
High level signal voltage	11...30 VDC (EN 61131-2, type 1 and 3)
Digital outputs	
Number of channels	8
Connectivity outputs	Screw terminals
Output type	PNP
Type of output diagnostics	Channel diagnostics
Output current per channel	1.0 A (Max 4.0 A total output)
Load type	resistive, inductive, lamp load
Short-circuit protection	yes
Electrical isolation	500 VDC

- Rugged, I/O hub in IP20
- Metal screw terminal connectors
- 8 universal digital channels, DI/DO
- 24 VDC, PNP
- Output current: 1.0 A
- I&M Data Sets Support Installation and Maintenance
- IO-Link Diagnostics for Short-Circuit and Supply Voltage
- Rear M12 connector for direct feeding through the cabinet wall

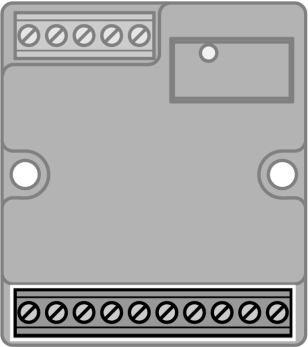
IO-Link	
Connectivity IO-Link	Screw terminals
IO-Link specification	V 1.1
IO-Link port type	Class A
Frame type	Supports all
Transmission rate	COM 2 / 38.4 kbps
Programming	FDT/DTM
Standard/Directive conformity	
Approvals and certificates	CE, UL
General Information	
Dimensions (W x L x H)	55 x 62.48 x 43 mm
Ambient temperature	-40...+70 °C
Storage temperature	-40...+85 °C
Altitude	Max. 5000 m
Protection class	IP20
MTTF	651 years acc. to SN 29500 (Ed. 99) 20 °C
Housing material	PA6-GF30
Housing color	Black
Mounting	Two mounting holes Ø 5 mm, Eurofast Mounting Hole Dimensions: 15.3mm Diameter

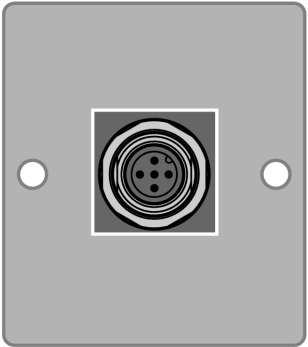
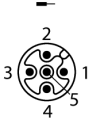
		<p>IO-Link Screw Terminals</p> <p>1 = V1 + 2 = n.c. 3 = V1 - 4 = C/Q 5 = n.c.</p> 
		<p>I/O Screw Terminals</p> <p>1 = V1 - 6 = I/O₄ 2 = I/O₀ 7 = I/O₅ 3 = I/O₁ 8 = I/O₆ 4 = I/O₂ 9 = I/O₇ 5 = I/O₃ 10 = V_{AUX} +</p> 
	<p>Rear M12 connector for direct feeding through the cabinet wall. Fieldbus cable (example): RK 4T-2 (ident no. U2151)</p>	<p>IO-Link Port M12</p>  <p>1 = V1 + 2 = n.c. 3 = V1 - 4 = C/Q 5 = n.c.</p>

Module LED status

LED indication	Color	Status	Description
IO-Link	Green	OFF	Power off
		Flashing	IO-Link communication OK, valid process data is being sent or received
	Red	ON	IO-Link communication or module error
		Flashing	IO-Link communication OK, invalid process data or diagnosis