

# RK 4.22T-0.2

## Actuator and Sensor Cable – Connection Cable

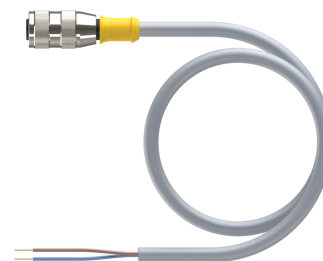
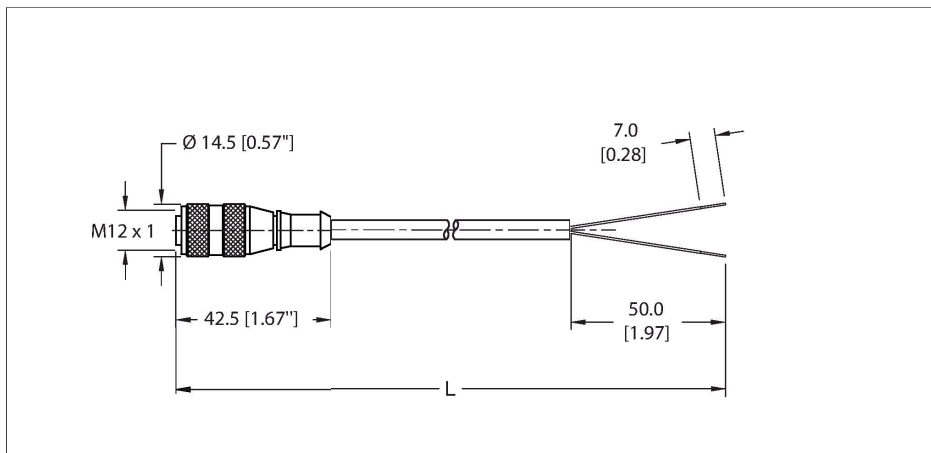

### Technische Daten

Type	RK 4.22T-0.2
ID	100007061
Connector A	Female, M12 × 1, Straight, A-code
Design specification	Acc. to IEC 61076-2-101
Number of contacts	4
Contacts	Brass, CuZn, Gold-plated
Contact carriers	Plastic, Nylon or TPU, Black
Connector body	Plastic, TPU, Yellow
Coupling nut	Brass, CuZn, Nickel-plated
Connector seal	O-ring, Plastic, FKM/FPM
Tightening torque (range)	0.8 ... 1 Nm (note max. torque of mating connector!)
Mechanical life	> 100 Mating cycles
Pollution degree	3
Protection class (When coupled)	IP68, IP69K NEMA: 1, 3, 4, 6P
<b>Cable data</b>	
Cable ID	RF50529
Total number of conductors	2
Cable diameter	Ø 5.13 mm
Length (L)	0.2 m, (+50mm or 4% of length/-0.0, Whichever is greater)
Cable jacket	PVC, Gray
Conductor diameter	0.061 "
Conductor material	TC (tinned copper)

### Features



- M12, Female, Straight, 2-pin
- Instrumentation Tray Cable
- Gray PVC jacket, 2X20 AWG
- Sunlight Resistant
- -40 Cold Bend Rating
- Oil Resistant
- Flame Ratings: UL 1685 FT4, UL1061, CSA FT4
- Flexlife® and C-Track Approved

### Cable cross section

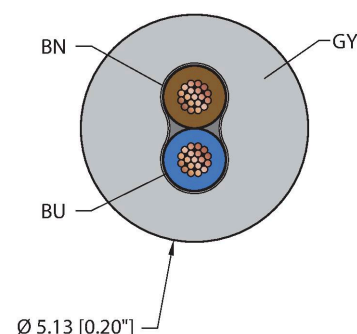

### Contact assignment

RK 4.22T-0.2 | 21-02-2025 21-54 | Technische Änderungen vorbehalten

## Connector A

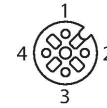

## Circuit Diagram

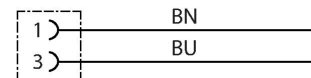

## Technische Daten

Conductor insulation material	PVC
Conductor size	2 x 20 AWG [Similar to 0.50 mm <sup>2</sup> ]
Number of strands x O.D.	19 x 0.0073 "
Conductor colors	BN, BU
<b>Electrical properties at +20 °C</b>	
Rated voltage	250 V
Current	4 A
<b>Mechanical and chemical properties</b>	
Bending radius (static)	≥ 5 x Ø
Bending radius (dynamic)	≥ 10 x Ø
UL cold bend rating	-40 °C
Flex rating 20 x Ø	10 million cycles
	*When properly installed @ 20°C, 50%RH, and a cycle speed of ≤0.5 cycles per second.
C-Track	Yes
Ambient temperature range (static)	-40...+105 °C
Ambient temperature range (dynamic)	5...+105 °C
Temperature range (installation)	-10...+105 °C
<b>Approval</b>	
Approvals	UL 2238 CSA C22.2 No. 182.3 CE UKCA RoHS

## Note

- Flex ratings may be reduced if used in extreme temperatures, exposure to certain chemicals, operating above the rated cycle speed, or operating below the rated cable bend radius.

- We reserve the right to make technical alterations without prior notice.

## Montagezubehör

### TORQUE-WRENCH-SET-M12-LEGACY

A900153

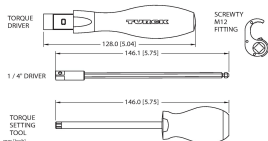

Adjustable torque driver to connect to a Ø15mm knurl. Compatible with the redesigned and legacy M12 cordsets. Includes (1) adjustable torque driver, (1) adjustment tool, (1) 1/4"square to 4mm hex adaptor bit, and (1) Ø15mm spring loaded clamp bit

## Montagezubehör

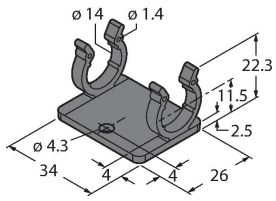
**M12-CORDSETS-MOUNTING-CLIP-(10/BAG)****100016882**

10 Pack of black mounting clips and M4x8mm mounting screws, used to secure cable to cable connection points.