

RI-12HA1S1-2K1024-H1181

Incremental Hollow Shaft Rotary Encoder

Industrial Line

Features

- Flange with tether arm for 40-75mm mounting diameters
- Hollow shaft, Ø 3/8"
- Optical measuring principle
- Shaft material: stainless steel
- Protection class IP67 on housing and shaft side
- -40...+85 °C
- Max. 6000 rpm (continuous operation 3000 rpm)
- 5...30 VDC
- Male connector, M12 x 1, 8-pole
- Push-pull, with inverted signals
- Pulse frequency max. 300 kHz
- 1024 pulses per revolution

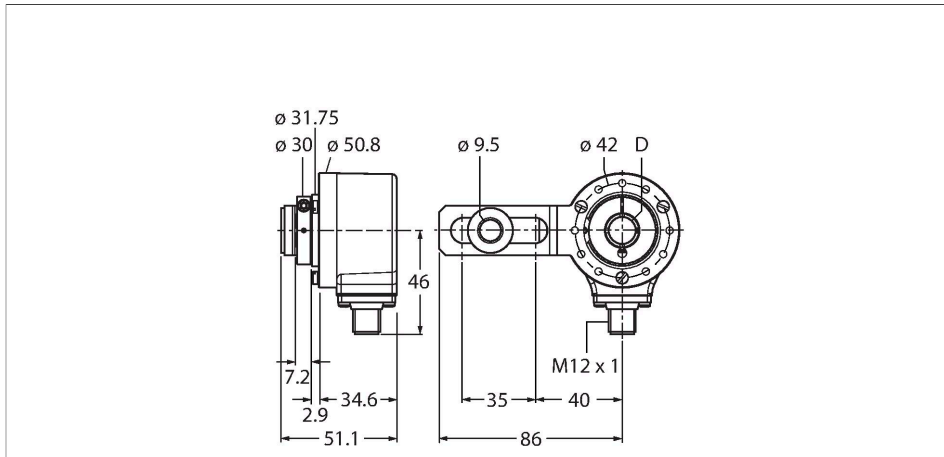

Technical data

Type	RI-12HA1S1-2K1024-H1181
ID	100026973
Measuring principle	Optical
General data	
Max. rotational speed	6000 rpm
Moment of inertia of the rotor	$6 \times 10^{-6} \text{ kgm}^2$
Starting torque	< 0.05 Nm
Output type	Incremental
Resolution, incremental	1024 ppr
Electrical data	
Operating voltage U_B	5...30 VDC
No-load current	$\leq 100 \text{ mA}$
Output current	$\leq 20 \text{ mA}$
Short-circuit protection	yes
Wire break/reverse polarity protection	no
Pulse frequency max.	300 kHz
Signal level high	min. $U_B - 2 \text{ V}$
Signal level low	max. 0.5 V
Output function	8-wire, Push-Pull 7272, with inverted signals
Mechanical data	
Flange type	Flange with mounting element
Shaft Type	Hollow shaft

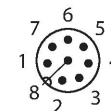
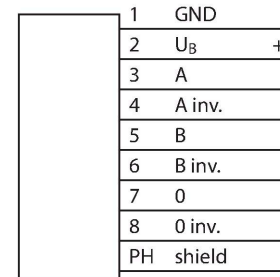

Technical data

Shaft diameter D (mm)	9.525
Shaft diameter D	0.375 in
Shaft material	Stainless steel
Housing material	Die-cast zinc
Electrical connection	Connector, M12 × 1
	8-pin
Axial shaft load	40 N
Radial shaft load	80 N
Environmental conditions	
Ambient temperature	-40...+85 °C
Vibration resistance (EN 60068-2-6)	300 m/s ² , 10...2000 Hz
Shock resistance (EN 60068-2-27)	3000 m/s ² , 6 ms
Protection class	IP67
Protection class shaft	IP67