

RI-43H38S8-4C4096-H1181

Incremental Hollow Shaft Rotary Encoder

Industrial Line

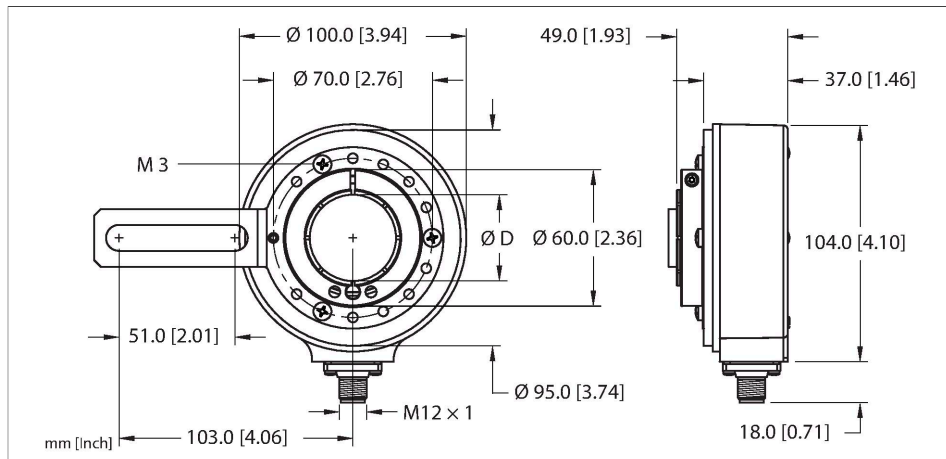

Technical data

Type	RI-43H38S8-4C4096-H1181
ID	100027118
Measuring principle	Optical
General data	
Max. Rotational Speed	6000 rpm
Moment of inertia of the rotor	$220 \times 10^{-6} \text{ kgm}^2$
Starting torque	< 0.2 Nm
Output type	Incremental
Resolution incremental	4096 ppr
Electrical data	
Operating voltage U_B	10...30 VDC
No-load current	$\leq 120 \text{ mA}$
Output current	$\leq 20 \text{ mA}$
Short-circuit protection	yes
Wire break/reverse polarity protection	yes
Pulse frequency max.	300 kHz
Signal level high	min. 2.5 V
Signal level low	max. 0.5 V
Output function	8-wire, RS422/TTL, with inverted signals
Mechanical data	
Flange type	Flange with mounting element
Flange diameter	$\varnothing 100 \text{ mm}$
Shaft Type	Blind hole shaft

Features

- Flange with long arm bracket, $\varnothing 100 \text{ mm}$
- Hollow shaft, $\varnothing 38 \text{ mm}$
- Optical measuring principle
- Shaft material: stainless steel
- Protection class IP65 on the shaft side
- -40...+80°C
- max. 6000 rev / min
- 10...30 VDC
- Male connector, M12 x 1 , 8-pole
- RS422 with inverted signals
- Pulse frequency max. 300 kHz
- 4096 pulses per revolution

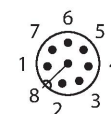
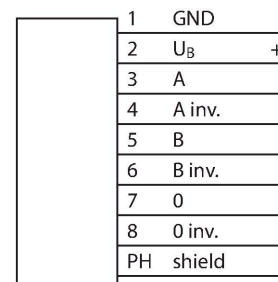

Technical data

Shaft diameter D (mm)	38
Shaft diameter D	1.496 in
Shaft material	Stainless steel
Housing material	Die-cast zinc
Electrical connection	Connector, M12 × 1
	8-pin
Axial shaft load	100 N
Radial shaft load	200 N
Environmental conditions	
Ambient temperature	-40...+80 °C
Vibration resistance (EN 60068-2-6)	10 g (100 m/s ²), 10...2000 Hz
Shock resistance (EN 60068-2-27)	200 g (1000 m/s ²), 6 ms
Protection class	IP65
Protection class shaft	IP65
Included in delivery	Mounting arm, long

Accessories

RA-43-S4

1545911

Stainless steel long anti-rotation spring 110 mm reference diameter

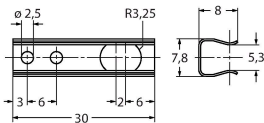

RA-43-E2

1545912

Stainless steel 4 1/2" C-face tether 149 mm reference diameter

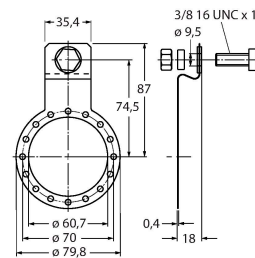

RA-43-S5

1545910

Stainless steel short anti-rotation spring 76 mm reference diameter

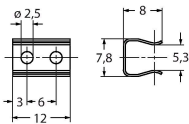

RA-43-S8

1545909

Stainless steel long tether arm 104 - 206 mm reference diameter

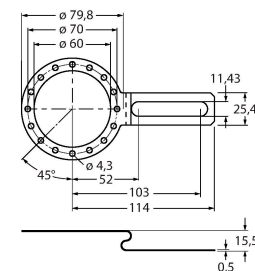

RA-43-E 1545946

Stainless steel slotted fexmount
119mm reference diameter

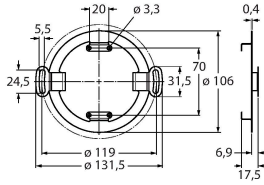

RSA-7 1544808

Inlay, outer diameter 38 mm, inner
diameter 12 mm

RME-5 1544616

Stainless steel mounting panel for
hollow shaft encoders, reference
diameter 149 mm, for applications
with axial play

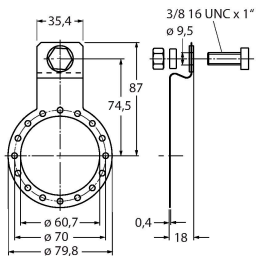

RME-6 1544617

Stainless steel mounting panel for
hollow shaft encoders, reference
diameter 104...206 mm, for
applications with fixing points on
adjustable reference diameter

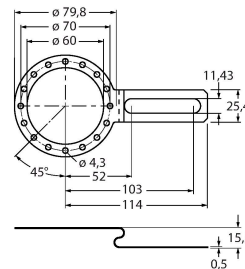

RME-10 1544621

Stainless steel mounting element for
hollow shaft encoders, pitch diameter
110 mm, for applications with high
axial play

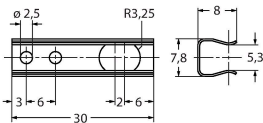

RME-11 1544622

Stainless steel mounting element for
hollow shaft encoders, pitch diameter
76 mm, for applications with limited
mounting space

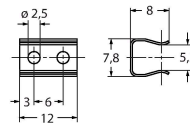

RME-15 1544626

Metal arm bracket, for hollow
shaft encoders, length 70 mm; for
applications with little axial and radial
play; flexibly adjustable

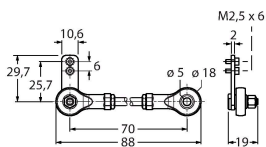

RME-16 1544627

Metal arm bracket, for hollow shaft
encoders, length 100 mm; for
applications with little axial and radial
play; flexibly adjustable

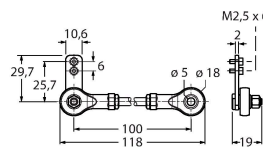

RME-17 1544628

Metal arm bracket, for hollow shaft
encoders, length 150 mm; for
applications with little axial and radial
play; flexibly adjustable

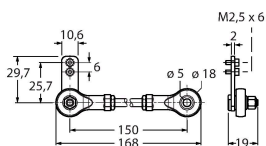

RME-18 1544629

Stainless steel stator coupling for
hollow shaft encoders, reference
diameter 119 mm, for highly dynamic
applications with axial and radial play

