

EKRB001-ESRB001-A5.500-WE2Y-2

Actuator and Sensor Cable – Extension Cable

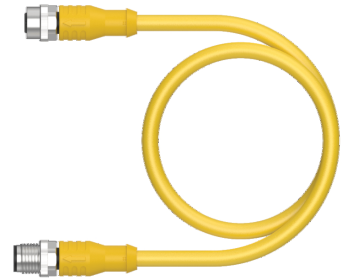
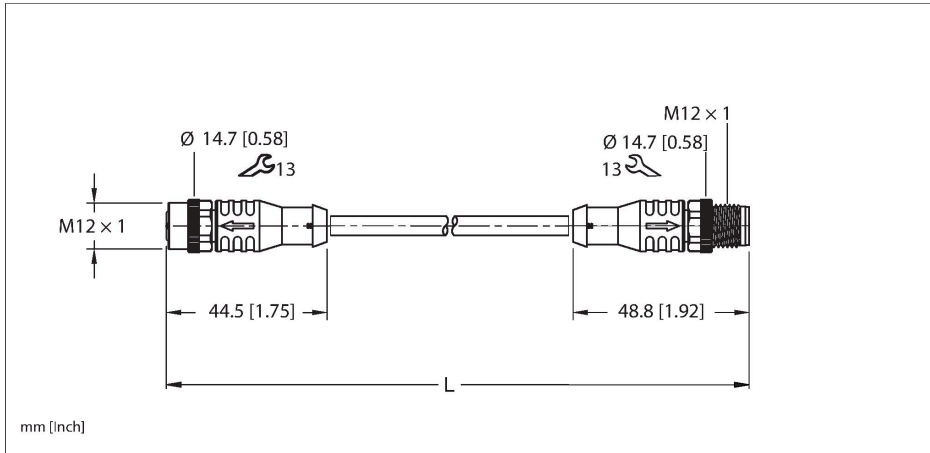

Technische Daten

| | |
|---------------------------------|---|
| Type | EKRB001-ESRB001-A5.500-WE2Y-2 |
| ID | 100033117 |
| Replaces | RK 4.5T-x-RS 4.5T/S1587 |
| Connector A | Female, M12 × 1, Straight, A-code |
| Design specification | Acc. to IEC 61076-2-101 |
| Number of contacts | 5 |
| Contacts | Bronze, CuSn, Gold-plated |
| Contact carriers | Plastic, Nylon or TPU, Black |
| Connector body | Plastic, TPU, Yellow |
| Coupling nut | Brass, CuZn, Nickel-plated |
| Connector seal | O-ring, Plastic, FKM/FPM |
| Tightening torque (range) | 0.4 ... 1.8 Nm (note max. torque of mating connector!) |
| Mechanical life | > 100 Mating cycles |
| Pollution degree | 3 |
| Protection class (When coupled) | IP67, IP68, IP69, IP69K NEMA: 1, 3, 4, 6P, 12 |
| Connector B | Male, M12 × 1, Straight, A-code |
| Design specification | Acc. to IEC 61076-2-101 |
| Number of contacts | 5 |
| Contacts | Bronze, CuSn, Gold-plated |
| Contact carriers | Plastic, Nylon or TPU, Black |
| Connector body | Plastic, TPU, Yellow |
| Coupling nut | Brass, CuZn, Nickel-plated |
| Tightening torque | 0.4 ... 1.8 Nm |

Features

-
- M12, Female, Straight, 5-pin
- M12, Male, Straight, 5-pin
- Instrumentation Tray Cable
- Yellow TPE jacket, 5X22 AWG
- Sunlight Resistant
- -40 Cold Bend Rating
- Oil Resistant
- Flame Ratings: UL 1685 FT4, UL1061, CSA FT4
- Flexlife® and C-Track Approved

Cable cross section

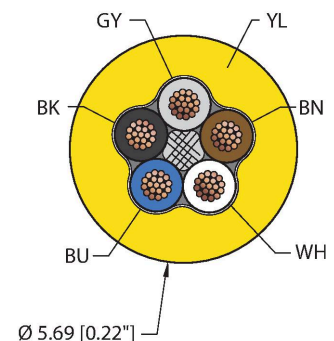

Contact assignment

EKRB001-ESRB001-A5.500-WE2Y-2 | 21-02-2025 20-40 | Technische Änderungen vorbehalten

Technische Daten

| | |
|---------------------------------|---|
| | (note max. torque of mating connector!) |
| Mechanical life | > 100 Mating cycles |
| Pollution degree | 3 |
| Protection class (When coupled) | IP67, IP68, IP69, IP69K |
| | NEMA: 1, 3, 4, 6P, 12 |

| Cable data | |
|-------------------------------|---|
| Cable ID | RF51898 |
| Total number of conductors | 5 |
| Cable diameter | Ø 5.69 mm |
| Length (L) | 2 m, (+50mm or 4% of length/-0.0, Whichever is greater) |
| Cable jacket | TPE, Yellow |
| Conductor diameter | 0.054 " |
| Conductor material | TC (tinned copper) |
| Conductor insulation material | PVC |
| Conductor size | 5 x 22 AWG [Similar to 0.34 mm ²] |
| Number of strands x O.D. | 19 x 0.0058 " |
| Conductor colors | BN, WH, BU, BK, GY |

| Electrical properties at +20 °C | |
|---------------------------------|--|
| Rated voltage | 250 V _{AC} /300 V _{DC} |
| Current | 4 A |

| Mechanical and chemical properties | |
|-------------------------------------|--|
| Bending radius (static) | ≥ 5 x Ø |
| Bending radius (dynamic) | ≥ 10 x Ø |
| UL cold bend rating | -40 °C |
| Flex rating 20 x Ø | 10 million cycles |
| | *When properly installed @ 20°C, 50%RH, and a cycle speed of ≤0.5 cycles per second. |
| C-Track | Yes |
| Ambient temperature range (static) | -40...+105 °C |
| Ambient temperature range (dynamic) | 5...+105 °C |
| Temperature range (installation) | -10...+105 °C |

| Approval | |
|-----------|--|
| Approvals | UL 2238 CSA C22.2 No. 182.3 CE UKCA RoHS |

Connector A

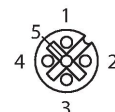

Connector B

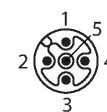

Circuit Diagram

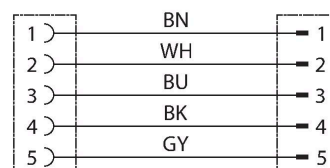

Technische Daten

Note

- Flex ratings may be reduced if used in extreme temperatures, exposure to certain chemicals, operating above the rated cycle speed, or operating below the rated cable bend radius.

- We reserve the right to make technical alterations without prior notice.

Montagezubehör

TORQUE-WRENCH-SET-M12/SW13 A900152

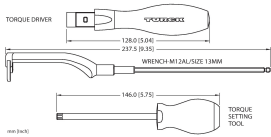

Adjustable torque driver to connect to the 13mm hex. Compatible with redesigned M12 cordsets, M12 Power, and M12 X-code. NOT Compatible with legacy M12 cordsets. Includes (1) adjustable torque driver, (1) adjustment tool, and (1) 13mm forked bit.

M12-TORQUE-SLEEVE,YELLOW(10PACK) A900167



10 Pack of Yellow Torque Sleeves for the new M12 cordsets. Compatible with male, female, straight and right-angled, stainless steel and nickel-plated brass coupling nuts.

Montagezubehör

M12-CORDSETS-MOUNTING-CLIP-(10/BAG) 100016882

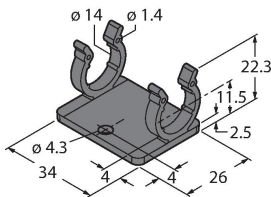

10 Pack of black mounting clips and M4x8mm mounting screws, used to secure cable to cable connection points.