

# BIM-INT-Y1X

## Magnetic Field Sensor – For Pneumatic Cylinders

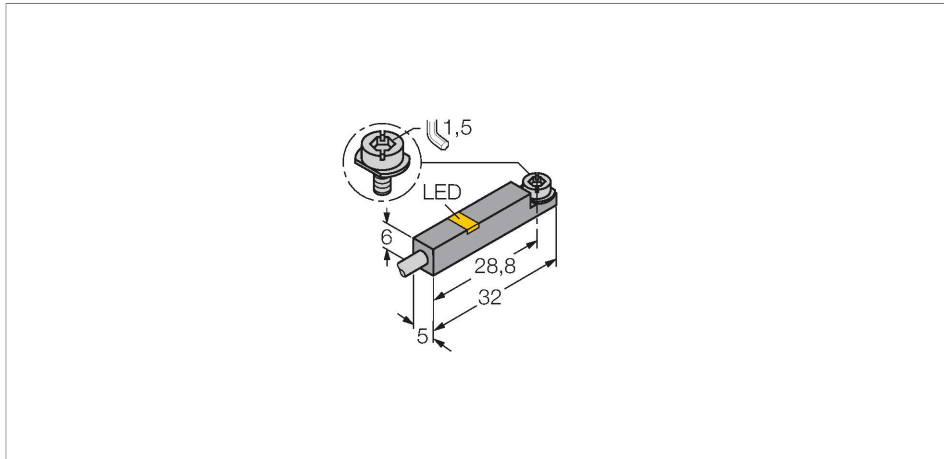

### Features

- Rectangular, height 6 mm
- Plastic, PP
- Magnetic-inductive sensor
- DC 2-wire, nom. 8.2 VDC
- Output acc. to DIN EN 60947-5-6 (NAMUR)
- Cable connection
- ATEX category II 1 G, Ex zone 0
- ATEX category II 1 D, Ex zone 20
- SIL2 (Low Demand Mode) acc. to IEC 61508, PL c acc. to ISO 13849-1 with HFT0
- SIL3 (All Demand Mode) acc. to IEC 61508, PL e acc. to ISO 13849-1 with redundant configuration HFT1

### Technical data

Type	BIM-INT-Y1X
ID	1056800
<b>General data</b>	
Pass speed	≤ 10 m/s
Repeatability	≤ ± 0.1 mm
Temperature drift	≤ 0.1 mm
Hysteresis	≤ 1 mm
<b>Electrical data</b>	
Output function	2-wire, NAMUR
Switching frequency	1 kHz
Voltage	Nom. 8.2 VDC
Current consumption non-actuated	≤ 1.2 mA
Actuated current consumption	≥ 2.1 mA
Approval acc. to	KEMA 02 ATEX 1090X
Internal capacitance (C <sub>i</sub> )/inductance (L <sub>i</sub> )	150 nF/150 μH
Device marking	Ex II 1 G Ex ia IIC T6 Ga/II 1 D Ex ia IIIC T135 °C Da (max. U <sub>i</sub> = 20 V, I <sub>i</sub> = 60 mA, P <sub>i</sub> = 80 mW)
<b>Mechanical data</b>	
Design	Rectangular, INT
Dimensions	32 x 5 x 6 mm
Housing material	Plastic, PP
Active area material	Plastic, PP
Tightening torque fixing screw	0.4 Nm

### Wiring diagram

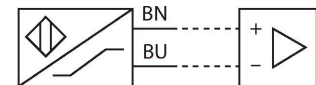

### Functional principle

Magnetic field sensors are activated by magnetic fields and are especially suited for piston position detection in pneumatic cylinders. Based on the fact that magnetic fields can permeate non-magnetizable metals, it is possible to detect a permanent magnet attached to the piston through the aluminium wall of the cylinder.

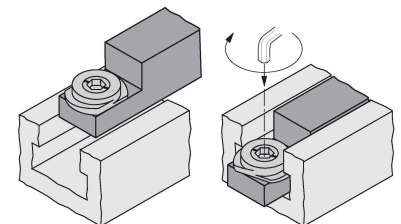

## Technical data

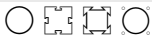
Electrical connection	Cable
Cable quality	Ø 3 mm, Blue, Lif9YYW, PVC, 2 m
Core cross-section	2 x 0.14 mm <sup>2</sup>
<b>Environmental conditions</b>	
Ambient temperature	-25...+70 °C
Vibration resistance	55 Hz (1 mm)
Shock resistance	30 g (11 ms)
Protection class	IP67
MTTF	6198 years acc. to SN 29500 (Ed. 99) 40 °C
<b>Mounting on the following profiles</b>	
Cylindrical design	
Switching state	LED, Yellow

## Accessories

KLZ1-INT

6970410

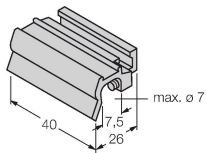

Accessories for mounting the sensors BIM-INT and BIM-UNT on tie-rod cylinders; cylinder diameter: 32... 40 mm; material: Aluminum; further mounting accessories for other cylinder diameters on request

KLDT-1

6913342

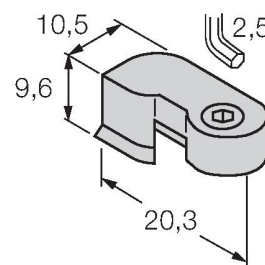

Clamping piece for mounting magnetic field sensors on dovetail groove cylinders; clamping width: 10.5... 12.4 mm; material: Aluminum; further mounting accessories for other clamping widths on request

KLR1

6970600

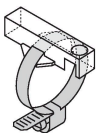

Mounting bracket for mounting magnetic field sensors on round cylinders using tensioning straps; material: Trogamid; please order retaining straps separately

INT STOPPER

6900473

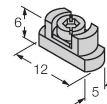

Accessories to secure the switchpoint on  T-groove cylinders; T-groove dimensions: 5...5.6 mm

## Instructions for use

### Intended use

This device fulfills Directive 2014/34/EC and is suited for use in explosion-hazardous areas according to EN 60079-0:2018 and EN 60079-11:2012. It is also suitable for use in safety-related systems, including SIL2 (IEC 61508) and PL c (ISO 13849-1) with HFT0 and SIL3 (IEC 61508) and PL e (ISO 13849-1) with redundant configuration HFT1 in order to ensure that the device is operated as intended, the national regulations and directives must be observed.

### For use in explosion hazardous areas conform to classification

II 1 G and II 1 D (Group II, Category 1 G, electrical equipment for gaseous atmospheres and category 1 D, electrical equipment for dust atmospheres).

### Marking (see device or technical data sheet)

Ex II 1 G and Ex ia IIC T6 Ga and Ex II 1 D Ex ia IIIC T135 °C Da acc. to EN 60079-0, -11

### Local admissible ambient temperature

-25...+70 °C

### Installation/Commissioning

These devices may only be installed, connected and operated by trained and qualified staff. Qualified staff must have knowledge of protection classes, directives and regulations concerning electrical equipment designed for use in explosion hazardous areas. Please verify that the classification and the marking on the device comply with the actual application conditions.

This device is only suited for connection to approved Exi circuits according to EN 60079-0 and EN 60079-11. Please observe the maximum admissible electrical values. After connection to other circuits the sensor may no longer be used in Exi installations. When interconnected to (associated) electrical equipment, it is required to perform the "Proof of intrinsic safety" (EN60079-14). Attention! When used in safety systems, all content of the security manual must be observed.

### Installation and mounting instructions

Avoid static charging of cables and plastic devices. Please only clean the device with a damp cloth. Do not install the device in a dust flow and avoid build-up of dust deposits on the device. If the devices and the cable could be subject to mechanical damage, they must be protected accordingly. They must also be shielded against strong electro-magnetic fields. The pin configuration and the electrical specifications can be taken from the device marking or the technical data sheet.

### Service/Maintenance

Repairs are not possible. The approval expires if the device is repaired or modified by a person other than the manufacturer. The most important data from the approval are listed.