

BIM-NST-Y1X-H1141

Magnetic Field Sensor – For Pneumatic Cylinders

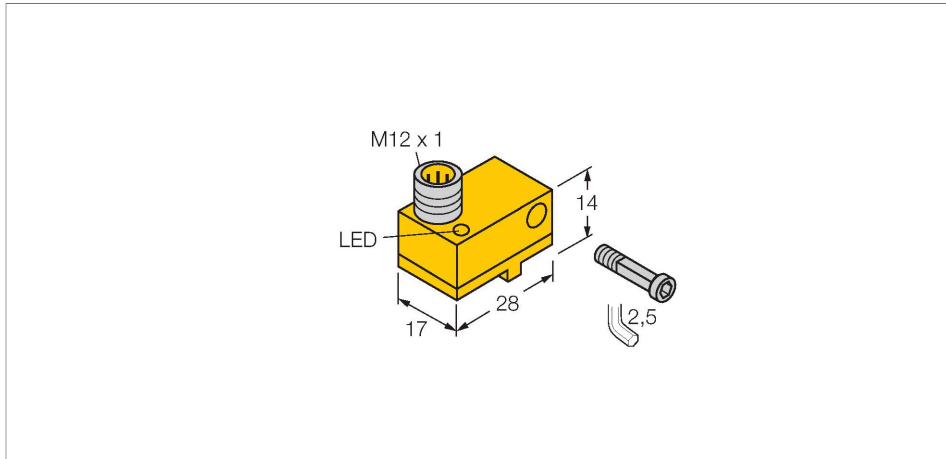

Features

- Plastic, PA12-GF30
- Magnetic-inductive sensor
- DC 2-wire, nom. 8.2 VDC
- Output acc. to DIN EN 60947-5-6 (NAMUR)
- Male connector M12 x 1
- ATEX category II 2 G, Ex Zone 1
- ATEX category II 1 D, Ex Zone 20
- SIL 2 (Low Demand Mode) acc. to IEC 61508, PL c acc. to ISO 13849-1 at HFT0
- SIL 3 (All Demand Mode) acc. to IEC 61508, PL e acc. to ISO 13849-1 with redundant configuration HFT1

Technical data

| | |
|---|---|
| Type | BIM-NST-Y1X-H1141 |
| ID | 1058600 |
| General data | |
| Pass speed | ≤ 10 m/s |
| Repeatability | ≤ ± 0.1 mm |
| Temperature drift | ≤ 0.1 mm |
| Hysteresis | ≤ 1 mm |
| Electrical data | |
| Output function | 2-wire, NAMUR |
| Switching frequency | 1 kHz |
| Voltage | Nom. 8.2 VDC |
| Current consumption non-actuated | ≤ 1.2 mA |
| Actuated current consumption | ≥ 2.1 mA |
| Approval acc. to | KEMA 02 ATEX 1090X |
| Internal capacitance (C _i)/inductance (L _i) | 150 nF/150 μH |
| Device marking | Ex II 2 G Ex ia IIC T6 Gb/II 1 D Ex ia IIIC T135 °C Da |
| | (max. U _i = 20 V, I _i = 60 mA, P _i = 130 mW) |
| Mechanical data | |
| Design | Rectangular, NST |
| Dimensions | 28 x 17 x 14 mm |
| Housing material | Plastic, PA12-GF30 |
| Active area material | Plastic, PA12-GF30 |
| Electrical connection | Connector, M12 × 1 |

Wiring diagram

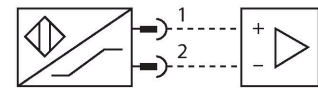
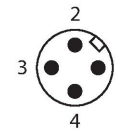



Functional principle

Magnetic field sensors are activated by magnetic fields and are especially suited for piston position detection in pneumatic cylinders. Based on the fact that magnetic fields can permeate non-magnetizable metals, it is possible to detect a permanent magnet attached to the piston through the aluminium wall of the cylinder.

Technical data

| Environmental conditions | |
|------------------------------------|---|
| Ambient temperature | -25...+70 °C |
| Vibration resistance | 55 Hz (1 mm) |
| Shock resistance | 30 g (11 ms) |
| Protection class | IP67 |
| MTTF | 6198 years acc. to SN 29500 (Ed. 99) 40 °C |
| Mounting on the following profiles | |
| Cylindrical design |  ### |
| Switching state | LED, Yellow |
| Included in delivery | 1 x screw M3x20, 1 x tension bolt, 1 x spring washer |

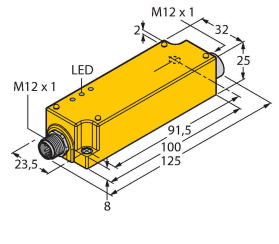
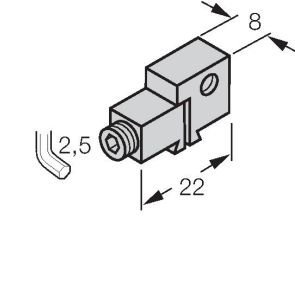
Accessories

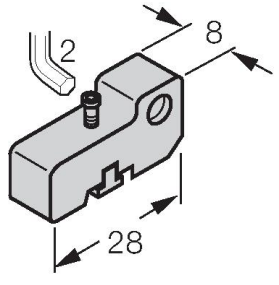
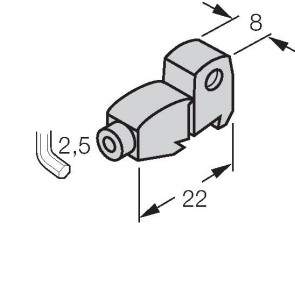
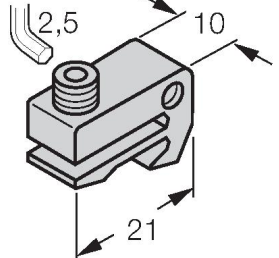
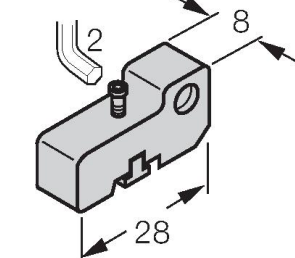
| | | | |
|---|--|--|--|
| IMC-DI-22EX-PNO/24VDC | 7560003 | KLN3 | 6970504 |
|  | <p>2-channel isolating switching amplifier with M12x1 males, for peripheral use, IP67, zones 2/22, input circuits II(1) Ex ia, PNP transistor output NO</p> |  | <p>Mounting bracket for mounting magnetic field sensors on dovetail groove cylinders or  T-groove cylinders; clamping width: 5.2... 13.5 mm; material: Anodized aluminum</p> |
| KLN-SMC | 6970503 | KLF1 | 6970401 |
|  | <p>Mounting bracket for mounting magnetic field sensors on SMC cylinders; clamping width 4 mm; material: Anodized aluminum</p> |  | <p>Mounting bracket for mounting magnetic field sensors on profile cylinders with external dovetail guide; for all cylinder diameters, material: Anodized aluminum</p> |
| KLF2 | 6970402 | SMC-325 | A3106 |
|  | <p>Mounting bracket for mounting magnetic field sensors on profile cylinders (IMI Norgren); cylinder diameter: 32... 100 mm; material: Anodized aluminum</p> |  | <p>Mounting bracket for mounting magnetic field sensors on SMC cylinders; clamping width 4 mm; material: Anodized aluminum</p> |

Instructions for use

Intended use

This device fulfills Directive 2014/34/EC and is suited for use in areas exposed to explosion hazards according to EN 60079-0:2018 and EN 60079-11:2012. Further it is suited for use in safety-related systems, including SIL2 as per IEC 61508. In order to ensure correct operation to the intended purpose it is required to observe the national regulations and directives.

For use in explosion hazardous areas conform to classification

II 2 G and II 1 D (Group II, Category 2 G, electrical equipment for gaseous atmospheres and category 1 D, electrical equipment for dust atmospheres).

Marking (see device or technical data sheet)

Ex II 2 G and Ex ia IIC T6 Gb and Ex II 1 D Ex ia IIIC T135 °C Da acc. to EN 60079-0, -11

Local admissible ambient temperature

-25...+70 °C

Installation/Commissioning

These devices may only be installed, connected and operated by trained and qualified staff. Qualified staff must have knowledge of protection classes, directives and regulations concerning electrical equipment designed for use in explosion hazardous areas. Please verify that the classification and the marking on the device comply with the actual application conditions.

This device is only suited for connection to approved Exi circuits according to EN 60079-0 and EN 60079-11. Please observe the maximum admissible electrical values. After connection to other circuits the sensor may no longer be used in Exi installations. When interconnected to (associated) electrical equipment, it is required to perform the "Proof of intrinsic safety" (EN60079-14). Attention! When used in safety systems, all content of the security manual must be observed.

Installation and mounting instructions

Avoid static charging of cables and plastic devices. Please only clean the device with a damp cloth. Do not install the device in a dust flow and avoid build-up of dust deposits on the device. If the devices and the cable could be subject to mechanical damage, they must be protected accordingly. They must also be shielded against strong electro-magnetic fields. The pin configuration and the electrical specifications can be taken from the device marking or the technical data sheet. In order to avoid contamination of the device, please remove possible blanking plugs of the cable glands or connectors only shortly before inserting the cable or opening the cable socket.

Service/Maintenance

Repairs are not possible. The approval expires if the device is repaired or modified by a person other than the manufacturer. The most important data from the approval are listed.