

B2N45H-Q20L60-2LU3-H1151 Inclinometer

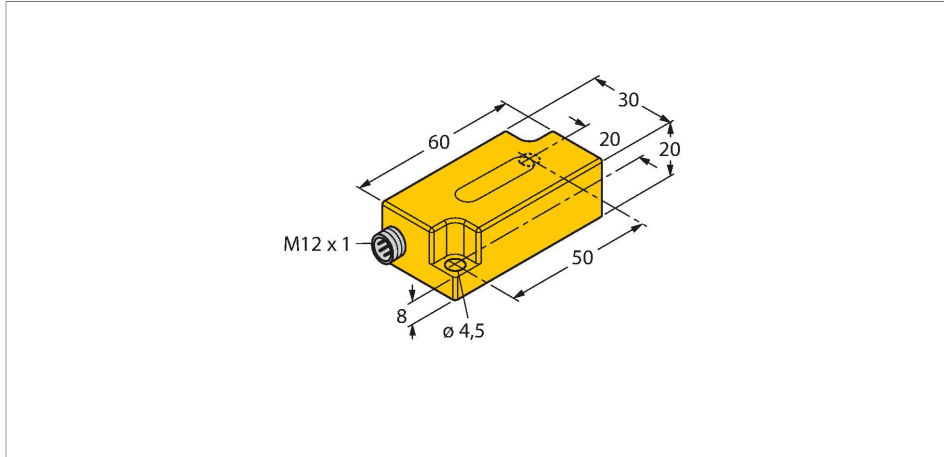

Features

- Plastic, PC
- Zero point calibration +/- 15°
- Two analog outputs
- M12 x 1 male connector

Wiring diagram

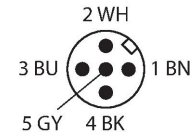
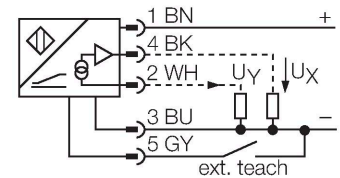

Technical data

Type	B2N45H-Q20L60-2LU3-H1151
ID	1534007
Measuring principle	Acceleration
General data	
Measuring range	-45...45 °
Measuring range x-axis	-45...45 °
Measuring range y-axis	-45...45 °
Number of measuring axes	2
Repeatability	≤ 0.2 % of measuring range A - B
Linearity deviation	≤ 0.5 %
Temperature drift	≤ ± 0.04 %/K
Resolution	≤ 0.1 °
Electrical data	
Operating voltage	10...30 VDC
Isolation test voltage	≤ 0.5 kV
Short-circuit protection	yes
Wire breakage/Reverse polarity protection	no / yes
Surge protection	-48...48 VDC [U _{b,max.}]
Output function	5-pin, Analog output
Voltage output	0.1...4.9 V
Load resistance voltage output	≥ 40 kΩ
Response time	0.1 s
	time for the output signal to achieve 90% full scale if the angle changes from -45° to +45°

Functional principle

Inclination is determined by a wear-free semiconducting sensor element.

Technical data

Current consumption	50 mA
Mechanical data	
Design	Rectangular, Q20L60
Dimensions	60 x 30 x 20 mm
Housing material	Plastic, PC
Electrical connection	Connector, M12 × 1
Environmental conditions	
Ambient temperature	-30...+70 °C
Vibration resistance	55 Hz (1 mm)
Shock resistance	30 g (11 ms)
Protection class	IP68 IP69K
MTTF	203 years acc. to SN 29500 (Ed. 99) 40 °C

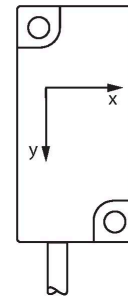
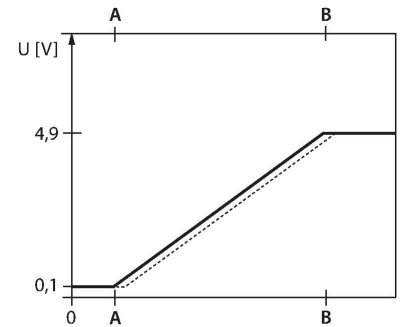
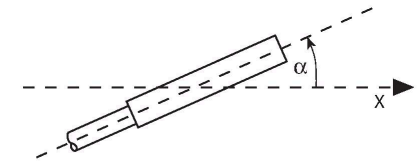

Mounting instructions

Mounting instructions/Description

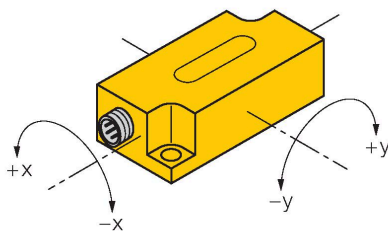

Teaching

The zero point can be adjusted with teach adapter TX1-Q20L60.

Teach-GND is pressed for approx. 1 s to do this. The outputs are switched to 5 V as confirmation.

Teach-GND is pressed for 6 s to reset the axis zero points. The outputs are switched to 0 V as confirmation.

Once the teach button is released, the sensor returns to normal operation.

Accessories

GUARD-Q20L60

A9684

Protective housing for Q20L60
inclinometers for protecting against
mechanical impact; material:
Stainless steel

