

RI-10S10C-2B1024-H1181

Incremental Encoder

Industrial Line

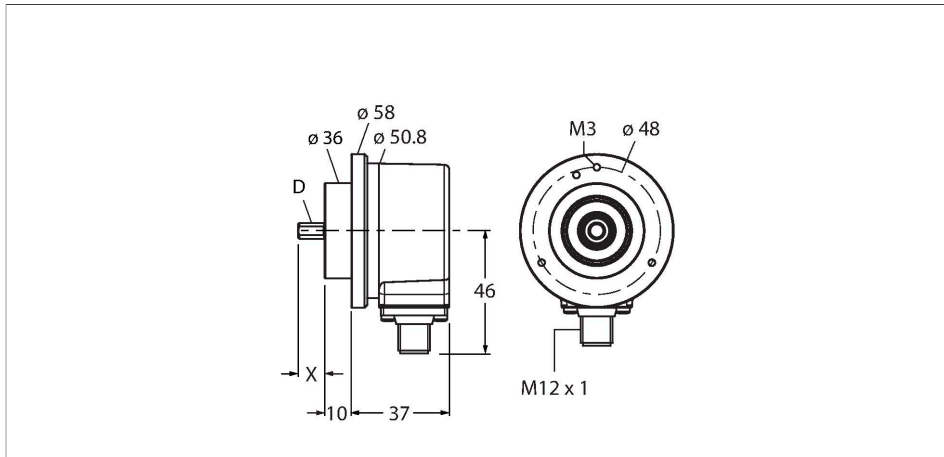

Technical data

Type	RI-10S10C-2B1024-H1181
ID	1544757
Measuring principle	Optical
General data	
Max. rotational speed	6000 rpm
Moment of inertia of the rotor	$1.8 \times 10^{-6} \text{ kgm}^2$
Starting torque	$< 0.05 \text{ Nm}$
Output type	Incremental
Resolution incremental	1024 ppr
Electrical data	
Operating voltage U_b	10...30 VDC
No-load current	$\leq 100 \text{ mA}$
Output current	$\leq 30 \text{ mA}$
Short-circuit protection	yes
Wire break/reverse polarity protection	yes
Pulse frequency max.	300 kHz
Signal level high	min. $U_b - 1 \text{ V}$
Signal level low	max. 0.5 V
Output function	Push-Pull/HTL, with inverted signals
Mechanical data	
Flange type	Clamping flange
Flange diameter	$\varnothing 58 \text{ mm}$
Shaft Type	Solid shaft

Features

- Clamping flange, $\varnothing 58 \text{ mm}$
- Solid shaft, $\varnothing 10 \text{ mm} \times 20 \text{ mm}$
- Optical measuring principle
- Shaft material: stainless steel
- Protection class IP67 on housing and shaft side
- $-40 \dots +85 \text{ }^\circ\text{C}$
- Max. 6000 rpm (continuous operation 3000 rpm)
- 10...30 VDC
- Male connector, M12 x 1, 8-pole
- Push-pull, with inverted signals
- Pulse frequency max. 300 kHz
- 1024 pulses per revolution

Wiring diagram

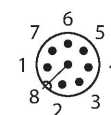
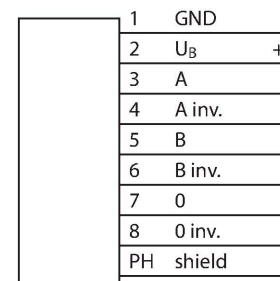

Technical data

Shaft diameter D (mm)	10
Shaft Length L [mm]	20
Shaft material	Stainless steel
Housing material	Die-cast zinc
Electrical connection	Connector, M12 × 1
	8-pin
Axial shaft load	50 N
Radial shaft load	100 N
Environmental conditions	
Ambient temperature	-40...+85 °C
Vibration resistance (EN 60068-2-6)	300 m/s ² , 10...2000 Hz
Shock resistance (EN 60068-2-27)	3000 m/s ² , 6 ms
Protection class	IP67
Protection class shaft	IP67

Accessories

<p>RA-BC-20-06-10 100048779</p> <p>Bellows coupling with aluminum hub Ø 20 mm; d1 = 6 mm, d2 = 10 mm</p> <p>2 mm 1.5 Nm</p>	<p>RA-BC-20-08-10 100048781</p> <p>Bellows coupling with aluminum hub Ø 20 mm; d1 = 8 mm, d2 = 10 mm</p> <p>2 mm 1.5 Nm</p>
<p>RA-BC-20-10-10 100048782</p> <p>Bellows coupling with aluminum hub Ø 20 mm; d1 = 10 mm, d2 = 10 mm</p> <p>2 mm 1.5 Nm</p>	<p>RA-BC-20-10-12 100048783</p> <p>Bellows coupling with aluminum hub Ø 20 mm; d1 = 10 mm, d2 = 12 mm</p> <p>2 mm 1.5 Nm</p>
<p>RA-BC-E-20-06-10 100048786</p> <p>Stainless steel bellows coupling Ø 20 mm; d1 = 6 mm, d2 = 10 mm</p> <p>2 mm 0.7 Nm</p>	<p>RA-BC-E-20-10-10 100048787</p> <p>Stainless steel bellows coupling Ø 20 mm; d1 = 10 mm, d2 = 10 mm</p> <p>2 mm 0.7 Nm</p>
<p>RA-BC-E-20-10-12 100048788</p> <p>Stainless steel bellows coupling Ø 20 mm; d1 = 10 mm, d2 = 12 mm</p> <p>2 mm 0.7 Nm</p>	<p>RA-SDC-30-10-10 100048792</p> <p>Spring disc coupling Ø 30 mm; d1 = 10 mm, d2 = 10 mm</p> <p>2.5 mm 1.2 Nm</p>
<p>RA-SDC-30-10-12 100048793</p> <p>Spring disc coupling Ø 30 mm; d1 = 10 mm, d2 = 12 mm</p> <p>2.5 mm 1.2 Nm</p>	<p>RA-HC-25-10-10 100048796</p> <p>Aluminum helix coupling Ø 25 mm; d1 = 10 mm, d2 = 10 mm</p> <p>2 mm 1.2 Nm</p>

RA-HC-25-10-12

100048797

Aluminum helix coupling \varnothing 25 mm; d1 = 10 mm, d2 = 12 mm

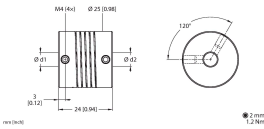

RFA-2

1544631

Aluminium flange adapter, rectangular, for solid shaft encoders with clamping flange; edge length 63.5 mm; 3 mm thick

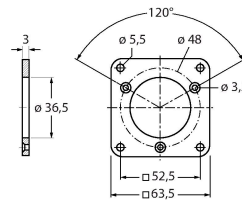

RFA-13

1544642

Aluminium flange adapter, rectangular, for solid shaft encoders with clamping flange; edge length 80 mm; 4 mm thick

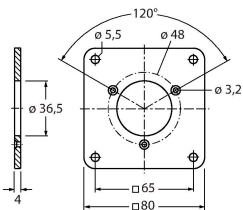

RFA-1

1544630

Aluminium flange adapter, rectangular, for solid shaft encoders with clamping flange; edge length 58 mm; 4 mm thick

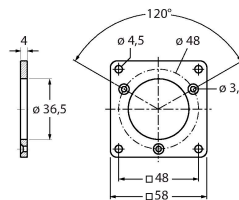

RFA-4

1544633

Euro flange – aluminium flange adapter for solid shaft encoders, \varnothing 115 mm; reference diameter 100 mm; adapts 58 mm clamping flange to Euro flange

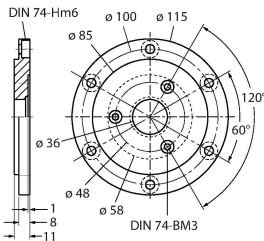

RFA-6

1544635

Aluminium flange adapter for solid shaft encoders with clamping flange, \varnothing 58 mm; adapts clamping flange to synchro flange

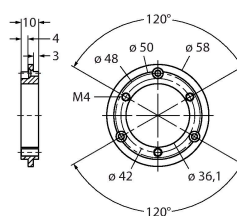

RFA-7

1544636

Aluminium flange adapter for solid shaft encoders, \varnothing 65 mm; adapts to \varnothing 65 mm flange and 48 mm reference diameter

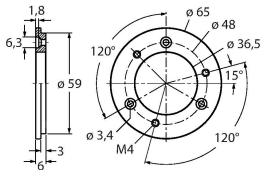

RFA-8

1544637

Aluminium flange adapter for solid shaft encoders with clamping flange, \varnothing 70 mm; thickness 4 mm, adapts to \varnothing 70 mm flange

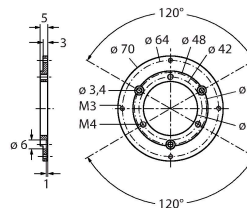

RFA-9

1544638

Aluminium angle flange for solid shaft encoders with \varnothing 58 mm clamping flange

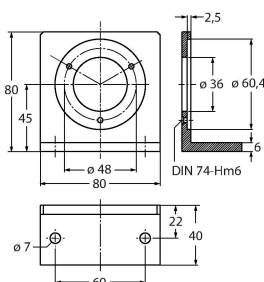

RFA-11

1544640

Aluminium flange adapter for solid shaft encoders with clamping flange, \varnothing 70 mm; thickness 10 mm, adapts to \varnothing 70 mm flange

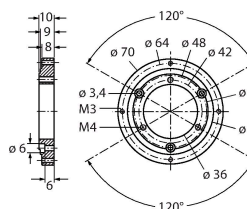

RFA-12

1544641

Aluminium flange adapter,
rectangular, for solid shaft encoders
with clamping flange; edge length 70
mm; 10 mm thick

