

RM-28S10S-3C25B-H1181

Absolute Rotary Encoder - Multiturn Industrial Line

Features

- Synchro flange, Ø 58 mm
- Solid shaft, Ø 10 mm × 20 mm
- Optical measuring principle
- Shaft material: stainless steel
- IP67 rated on shaft side
- -40...+70 °C
- Max. 9000 rpm
- 10...30 VDC
- SSI, gray
- M12 connector, 8-pin
- Singleturn, 13-bit resolution
- Multiturn, 12-bit resolution

Wiring diagram

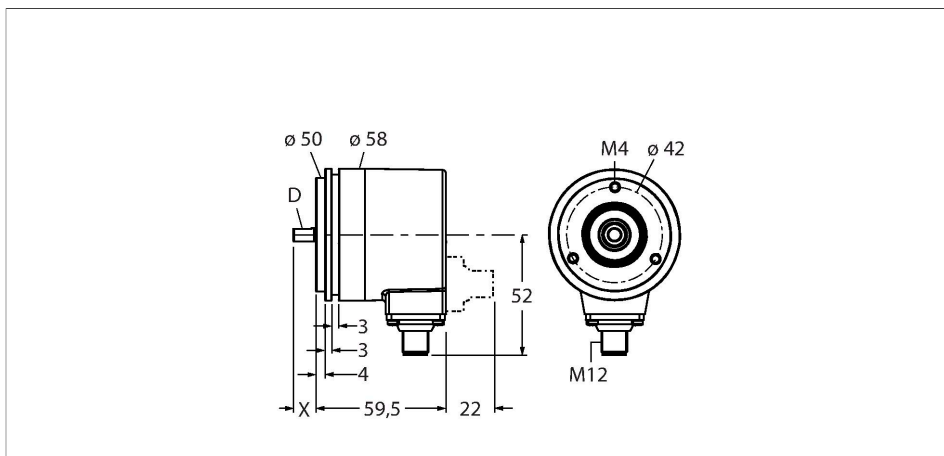
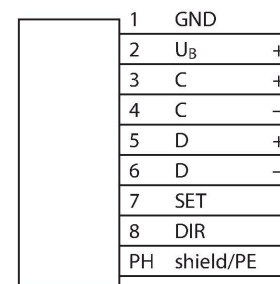

Technical data

Type	RM-28S10S-3C25B-H1181
ID	1545241
Measuring principle	Optical
General data	
Max. rotational speed	9000 rpm
Moment of inertia of the rotor	4 × 10 ⁻⁶ kgm ²
Starting torque	< 0.01 Nm
Output type	Absolute multiturn
Resolution singleturn	13 Bit
Resolution multiturn	12 Bit
Electrical data	
Operating voltage U _B	10...30 VDC
No-load current	≤ 50 mA
Output current	≤ 20 mA
Short-circuit protection	yes
Wire break/reverse polarity protection	yes
Signal level high	typ. 3.8 V
Signal level low	typ. 1.3 V
Communication protocol	SSi
Output function	Gray coded
Mechanical data	
Flange type	Synchro flange
Flange diameter	Ø 58 mm

Technical data

Shaft Type	Solid shaft
Shaft diameter D (mm)	10
Shaft Length L [mm]	20
Shaft material	Stainless steel
Housing material	Die-cast zinc
Electrical connection	Connector, M12 × 1
	8-pin
Axial shaft load	40 N
Radial shaft load	80 N
Environmental conditions	
Ambient temperature	-40...+70 °C
Vibration resistance (EN 60068-2-6)	100 m/s ² , 55...2000 Hz
Shock resistance (EN 60068-2-27)	2500 m/s ² , 6 ms
Protection class housing	IP67
Protection class shaft	IP67

Accessories

RFA-2

1544631

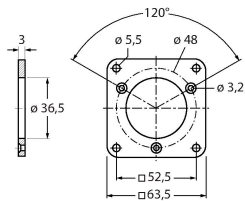

Aluminium flange adapter, rectangular, for solid shaft encoders with clamping flange; edge length 63.5 mm; 3 mm thick

RFA-4

1544633

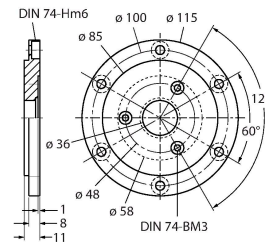

Euro flange – aluminium flange adapter for solid shaft encoders, Ø 115 mm; reference diameter 100 mm; adapts 58 mm clamping flange to Euro flange

RFA-6

1544635

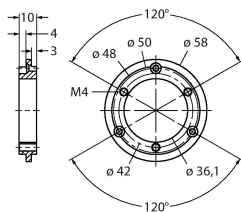

Aluminium flange adapter for solid shaft encoders with clamping flange, Ø 58 mm; adapts clamping flange to synchro flange

RFA-7

1544636

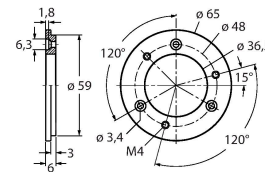

Aluminium flange adapter for solid shaft encoders, Ø 65 mm; adapts to Ø 65 mm flange and 48 mm reference diameter

RFA-8 1544637

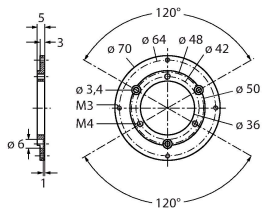

Aluminium flange adapter for solid shaft encoders with clamping flange, Ø 70 mm; thickness 4 mm, adapts to Ø 70 mm flange

RFA-9 1544638

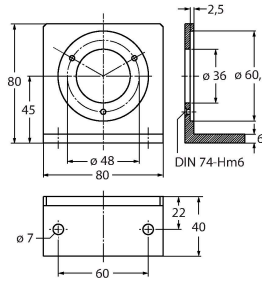

Aluminium angle flange for solid shaft encoders with Ø 58 mm clamping flange

RFA-11 1544640

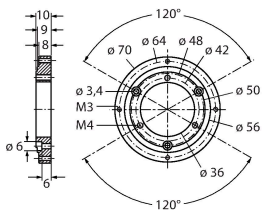

Aluminium flange adapter for solid shaft encoders with clamping flange, Ø 70 mm; thickness 10 mm, adapts to Ø 70 mm flange

RFA-12 1544641

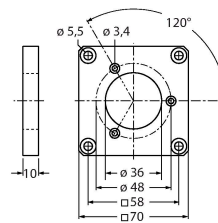

Aluminium flange adapter, rectangular, for solid shaft encoders with clamping flange; edge length 70 mm; 10 mm thick

RFA-13 1544642

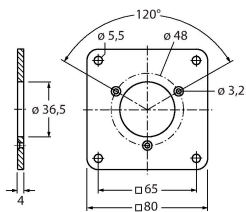

Aluminium flange adapter, rectangular, for solid shaft encoders with clamping flange; edge length 80 mm; 4 mm thick

RFA-1 1544630

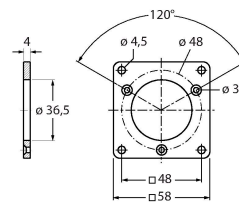

Aluminium flange adapter, rectangular, for solid shaft encoders with clamping flange; edge length 58 mm; 4 mm thick