

Accessories

Protecting Ring and Shield Plate

For Encoders RI-QR24

M3-QR24

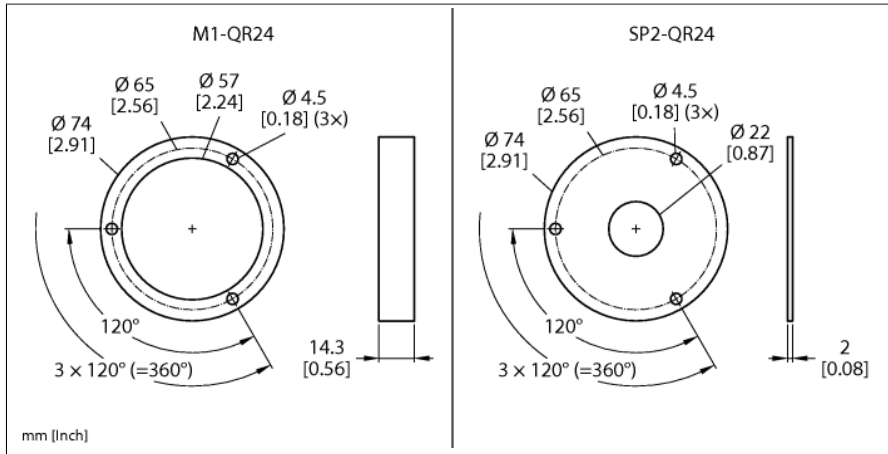

- Positioning element
- Hollow shaft, internal diameter 6 mm
- Incl. mounting option for shaft adapter

Type	M3-QR24
ID	1590918
Housing material	Aluminium