

Accessories

Shield Plate

For Encoders RI-QR24

SP2-QR24

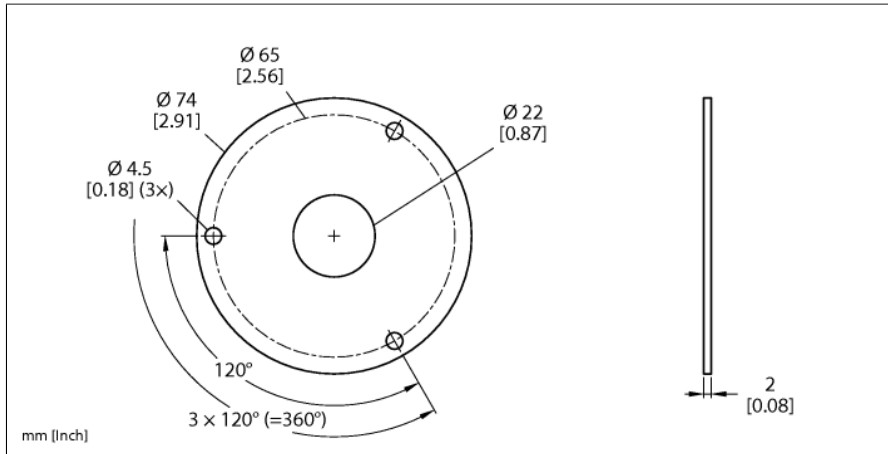

- Positioning element
- Hollow shaft, internal diameter 6 mm
- Incl. mounting option for shaft adapter

Type	SP2-QR24
ID	1590939
Housing material	Aluminium