

EKRT-ESWT-A4.400-FE24-4.5

Actuator and Sensor Cable – Extension Cable

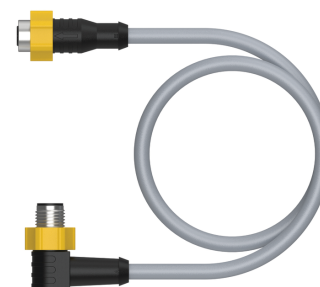
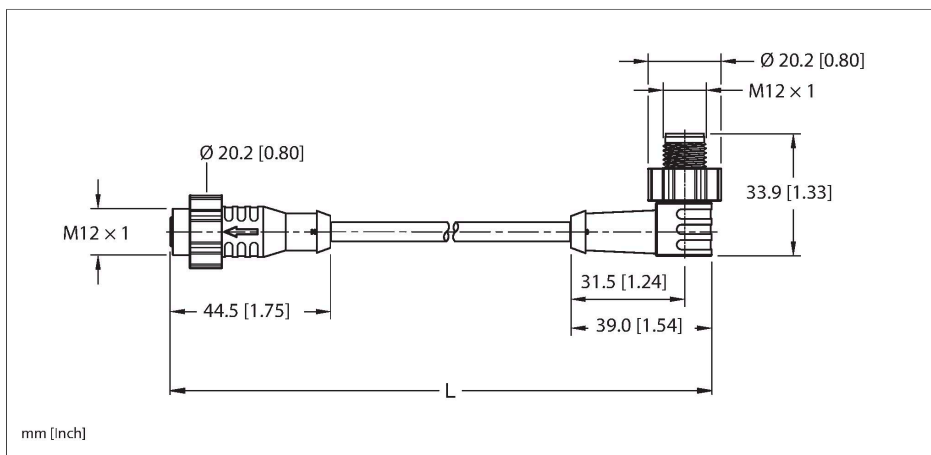

Technische Daten

Type	EKRT-ESWT-A4.400-FE24-4.5
ID	200003614
Replaces	RK 4.4T-x-WS 4.4T/S101
Connector A	Female, M12 × 1, Straight, A-code
Design specification	Acc. to IEC 61076-2-101
Number of contacts	4
Contacts	Bronze, CuSn, Gold-plated
Contact carriers	Plastic, Nylon or TPU, Black
Connector body	Plastic, TPU, Black
Coupling nut	Brass, CuZn, Nickel-plated
Connector seal	O-ring, Plastic, FKM/FPM
Torque sleeve	Plastic, PA, Yellow
Tightening torque (range)	0.4 ... 1.8 Nm (note max. torque of mating connector!)
Mechanical life	> 100 Mating cycles
Pollution degree	3
Protection class (When coupled)	IP67, IP68, IP69, IP69K NEMA: 1, 3, 4, 6P, 12
Connector B	Male, M12 × 1, Right angle, A-code
Design specification	Acc. to IEC 61076-2-101
Number of contacts	4
Contacts	Bronze, CuSn, Gold-plated
Contact carriers	Plastic, Nylon or TPU, Black
Connector body	Plastic, TPU, Black
Coupling nut	Brass, CuZn, Nickel-plated

Features

-
- M12, Female, Straight, 4-pin, Torque sleeve
- M12, Male, Right-angle, 4-pin, Torque sleeve
- Gray TPE jacket, 4X22 AWG
- -40 Cold Bend Rating
- Flame Ratings: UL1061, CSA FT1
- Flexlife® and C-Track Approved

Cable cross section

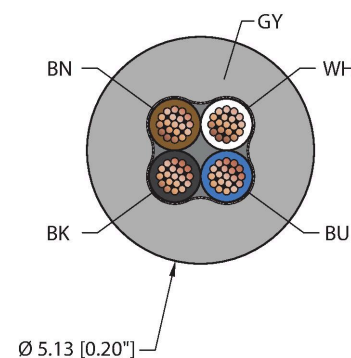

Contact assignment

EKRT-ESWT-A4.400-FE24-4.5 | 21-02-2025 21-18 | Technische Änderungen vorbehalten

Technische Daten

Torque sleeve	Plastic, PA, Yellow
Tightening torque	0.4 ... 1.8 Nm (note max. torque of mating connector!)
Mechanical life	> 100 Mating cycles
Pollution degree	3
Protection class (When coupled)	IP67, IP68, IP69, IP69K NEMA: 1, 3, 4, 6P, 12

Cable data	
Cable ID	RF50941
Total number of conductors	4
Cable diameter	Ø 5.13 mm
Length (L)	4.5 m, (+50mm or 4% of length/-0.0, Whichever is greater)
Cable jacket	TPE, Gray
Conductor diameter	0.046 "
Conductor material	TC (tinned copper)
Conductor insulation material	TPC-ET
Conductor size	4 x 22 AWG [Similar to 0.34 mm ²]
Number of strands x O.D.	19 x 0.0058 "
Conductor colors	BN, WH, BU, BK

Electrical properties at +20 °C	
Rated voltage	250 V _{AC} /300 V _{DC}
Current	4 A

Mechanical and chemical properties	
Bending radius (static)	≥ 5 x Ø
Bending radius (dynamic)	≥ 10 x Ø
Torsion rating	Max. 20 million
UL cold bend rating	-40 °C
Flex rating 10 x Ø	20 million cycles

*When properly installed @ 20°C, 50%RH, and a cycle speed of ≤0.5 cycles per second.

C-Track	Yes
Ambient temperature range (static)	-40...+105 °C
Ambient temperature range (dynamic)	5...+105 °C
Temperature range (installation)	-10...+105 °C

Approval	
Approvals	UL 2238 CSA C22.2 No. 182.3 CE UKCA

Connector A

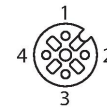

Connector B

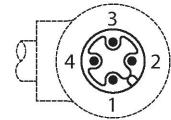

Circuit Diagram



Technische Daten

RoHS

Note
- Flex ratings may be reduced if used in extreme temperatures, exposure to certain chemicals, operating above the rated cycle speed, or operating below the rated cable bend radius.
- The torque sleeve can be removed, before or after installation by inserting a small flat screwdriver near the relief by the arrow and prying.
- We reserve the right to make technical alterations without prior notice.

Montagezubehör

M12-TORQUE-SLEEVE,YELLOW(10PACK)	A900167
	10 Pack of Yellow Torque Sleeves for the new M12 cordsets. Compatible with male, female, straight and right-angled, stainless steel and nickel-plated brass coupling nuts.

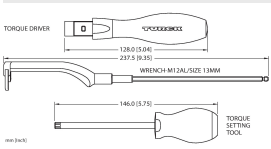
TORQUE-WRENCH-SET-M12/SW13	A900152
	Adjustable torque driver to connect to the 13mm hex. Compatible with redesigned M12 cordsets, M12 Power, and M12 X-code. NOT Compatible with legacy M12 cordsets. Includes (1) adjustable torque driver, (1) adjustment tool, and (1) 13mm forked bit.

Montagezubehör

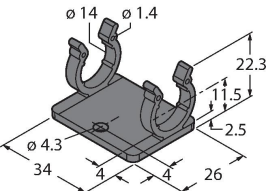
M12-CORDSETS-MOUNTING-CLIP-(10/BAG)	100016882
	10 Pack of black mounting clips and M4x8mm mounting screws, used to secure cable to cable connection points.

EKRT-ESWT-A4.400-FE24-4.5J 21-02-2025 21-18 | Technische Änderungen vorbehalten