

BI15-G30-ADZ30X2-B3131

Inductive Sensor – With Increased Switching Distance

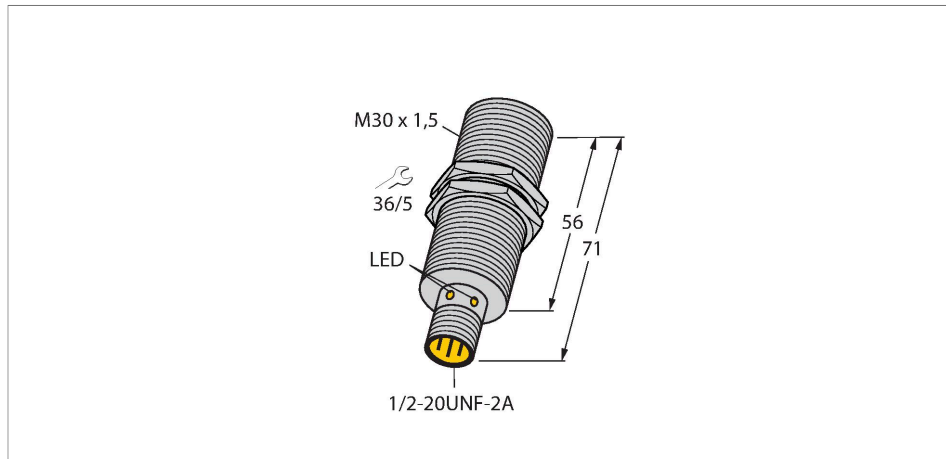

Features

- Threaded barrel, M30 x 1.5
- Chrome-plated brass
- Large sensing range
- AC 2-wire, 20...250 VAC
- DC 2-wire, 10...300 VDC
- NO contact
- 1/2" male connector

Wiring diagram

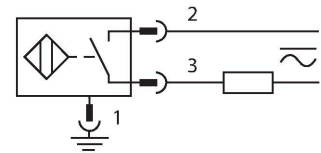

Technical data

Type	BI15-G30-ADZ30X2-B3131
ID	4207201
General data	
Rated switching distance	15 mm
Mounting conditions	Flush
Secured operating distance	$\leq (0.81 \times S_n)$ mm
Correction factors	St37 = 1; Al = 0.3; stainless steel = 0.7; Ms = 0.4
Repeat accuracy	≤ 2 % of full scale
Temperature drift	$\leq \pm 10$ %
Hysteresis	3...15 %
Electrical data	
Operating voltage	20...250 VAC
Operating voltage	10...300 VDC
AC rated operational current	≤ 400 mA
DC rated operational current	≤ 300 mA
Frequency	$\geq 50... \leq 60$ Hz
Residual current	≤ 1.7 mA
Isolation test voltage	≤ 1.5 kV
Surge current	≤ 3 A (≤ 20 ms max. 5 Hz)
Short-circuit protection	yes / Latching
Voltage drop at I_o	≤ 6 V
Wire breakage/Reverse polarity protection	yes / Complete
Output function	2-wire, NO contact, 2-wire

Functional principle

Inductive sensors detect metal objects contactless and wear-free. For this, they use a high-frequency electromagnetic AC field that interacts with the target. Inductive sensors generate this field via an RLC circuit with a ferrite coil.

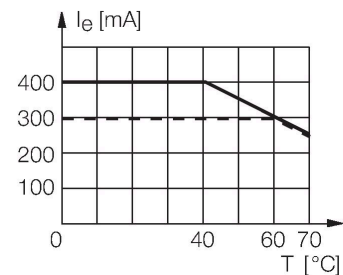

Technical data

Smallest operating current	≥ 3 mA
Switching frequency	0.02 kHz
Mechanical data	
Design	Threaded barrel, M30 x 1.5
Dimensions	71 mm
Housing material	Metal, CuZn, Chrome-plated
Active area material	Plastic, PBT-GF30
Max. tightening torque of housing nut	75 Nm
Electrical connection	Connector, 1/2"
Environmental conditions	
Ambient temperature	-25...+70 °C
Vibration resistance	55 Hz (1 mm)
Shock resistance	30 g (11 ms)
Protection class	IP67
MTTF	2283 years acc. to SN 29500 (Ed. 99) 40 °C
Power-on indication	LED, Green
Switching state	LED, Red

Mounting instructions

Mounting instructions/Description



Distance D	2 x B
Distance W	3 x Sn
Distance T	3 x B
Distance S	1.5 x B
Distance G	6 x Sn
Diameter active area B	Ø 30 mm

Accessories

QM-30

6945103

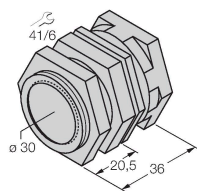

Quick-mount bracket with dead-stop; material: Chrome-plated brass. Male thread M36 x 1.5. Note: The switching distance of the proximity switches may change when using quick-mount brackets.

BST-30B

6947216

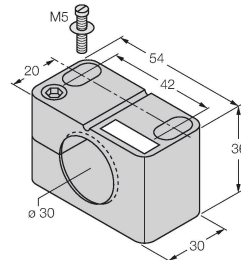

Mounting clamp for threaded barrel sensors, with dead-stop; material: PA6

MW-30

6945005

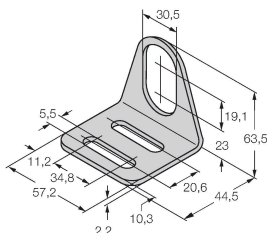

Mounting bracket for threaded barrel sensors; material: Stainless steel A2 1.4301 (AISI 304)

BSS-30

6901319

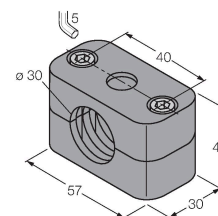

Mounting clamp for smooth and threaded barrel sensors; material: Polypropylene