

# BI5U-G18-ADZ30X2-B4331

## Inductive Sensor

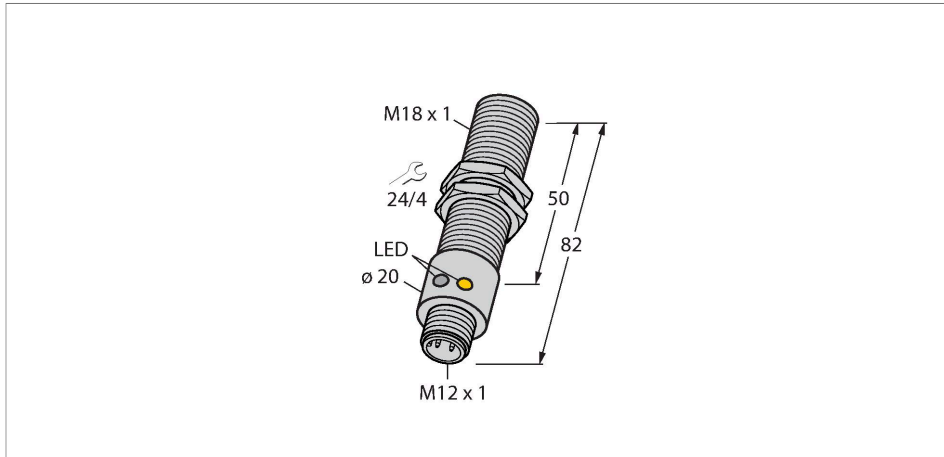

### Features

- Threaded barrel, M18 x 1
- Chrome-plated brass
- Factor 1 for all metals
- Protection class IP68
- Resistant to magnetic fields
- Extended temperature range
- High switching frequency
- AC 2-wire, 20...250 VAC
- DC 2-wire, 10...300 VDC
- NO contact
- M12 x 1 male connector (AC)

### Technical data

Type	BI5U-G18-ADZ30X2-B4331
ID	4281214
<b>General data</b>	
Rated switching distance	5 mm
Mounting conditions	Flush
Secured operating distance	$\leq (0.81 \times S_n)$ mm
Repeat accuracy	$\leq 2 \%$ of full scale
Temperature drift	$\leq \pm 10 \%$
	$\leq \pm 15 \%, \leq -25 \text{ }^\circ\text{C} \vee \geq +70 \text{ }^\circ\text{C}$
Hysteresis	3...15 %
<b>Electrical data</b>	
Operating voltage	20...250 VAC
Operating voltage	10...300 VDC
AC rated operational current	$\leq 400 \text{ mA}$
DC rated operational current	$\leq 300 \text{ mA}$
Frequency	$\geq 50 \dots \leq 60 \text{ Hz}$
Residual current	$\leq 1.7 \text{ mA}$
Isolation test voltage	$\leq 1.5 \text{ kV}$
Surge current	$\leq 3 \text{ A} (\leq 20 \text{ ms max. } 5 \text{ Hz})$
Short-circuit protection	yes / Latching
Voltage drop at $I_o$	$\leq 6 \text{ V}$
Wire breakage/Reverse polarity protection	yes / Complete
Output function	2-wire, NO contact, 2-wire
DC field stability	300 mT

### Wiring diagram

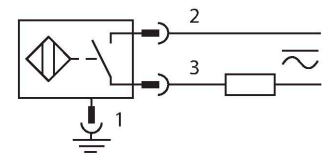

### Functional principle

Inductive sensors are designed for wear-free and contactless detection of metal objects. approx Factor 1 sensors have significant advantages due to their patented ferrite-coreless multi-coil system. They detect all metals at the same large switching distance and are resistant to magnetic fields.

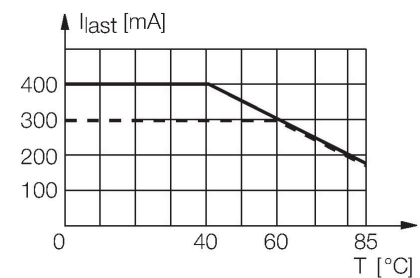

## Technical data

AC field stability	300 mT <sub>ss</sub>
Smallest operating current	≥ 3 mA
Insulation class	□
Switching frequency	0.01 kHz
<b>Mechanical data</b>	
Design	Threaded barrel, M18 x 1
Dimensions	82 mm
Housing material	Metal, CuZn, Chrome-plated
Active area material	Plastic, PBT
Max. tightening torque of housing nut	25 Nm
Electrical connection	Connector, M12 × 1
<b>Environmental conditions</b>	
Ambient temperature	-30...+85 °C
Vibration resistance	55 Hz (1 mm)
Shock resistance	30 g (11 ms)
Protection class	IP68
MTTF	874 years acc. to SN 29500 (Ed. 99) 40 °C
Power-on indication	LED, Green
Switching state	LED, Yellow

## Mounting instructions

### Mounting instructions/Description

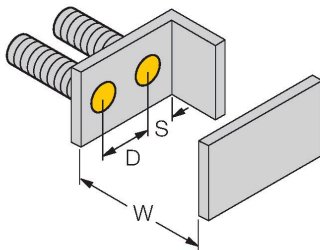
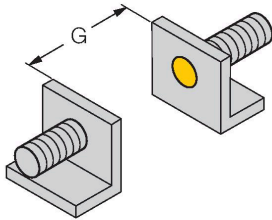
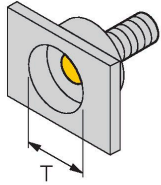

Distance D 2 x B

Distance W 3 x Sn

Distance T 3 x B

Distance S 1.5 x B

Distance G 6 x Sn

Diameter active area B  $\varnothing$  18 mm

## Accessories

MW-18

6945004

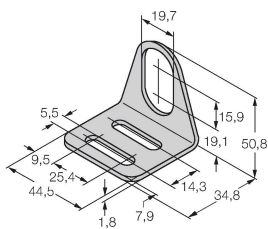

Mounting bracket for threaded barrel sensors; material: Stainless steel A2 1.4301 (AISI 304)

BSS-18

6901320

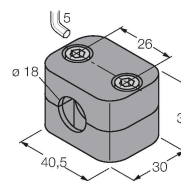

Mounting clamp for smooth and threaded barrel sensors; material: Polypropylene

QM-18

6945102

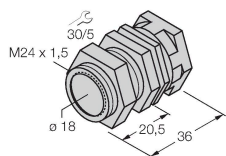

Quick-mount bracket with dead-stop; material: Chrome-plated brass. Male thread M24 x 1.5. Note: The switching distance of the proximity switches may change when using quick-mount brackets.