

BIM-IKT-AP6X-H1141 W/KLI3

Magnetic Field Sensor – For Pneumatic Cylinders

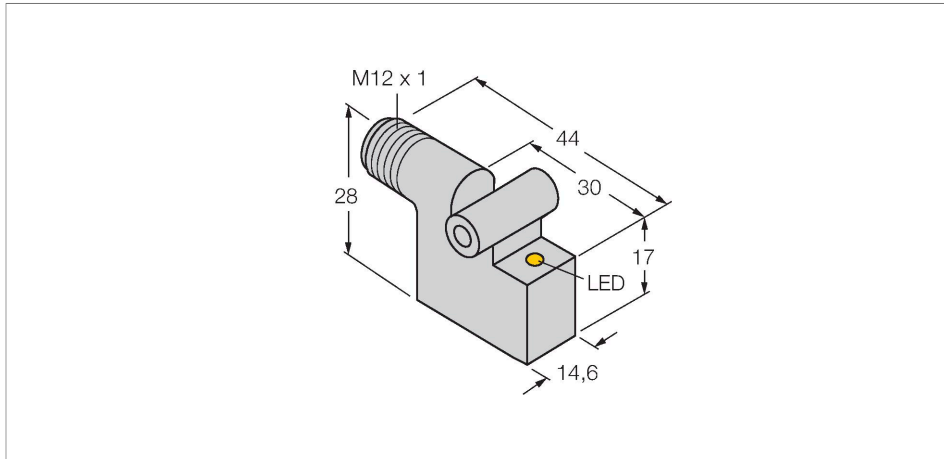

Features

- Rectangular, height 28 mm
- Metal, GD-Zn
- Magnetic-inductive sensor
- DC 3-wire, 10...30 VDC
- NO contact, PNP output
- Male connector, M12 x 1

Wiring diagram

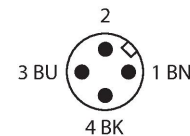
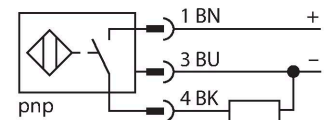

Technical data

Type	BIM-IKT-AP6X-H1141 W/KLI3
ID	4621090
General data	
Pass speed	≤ 10 m/s
Repeatability	≤ ± 0.1 mm
Temperature drift	≤ 0.1 mm
Hysteresis	≤ 1 mm
Electrical data	
Operating voltage	10...30 VDC
Residual ripple	≤ 10 % U _{ss}
DC rated operational current	≤ 200 mA
No-load current	15 mA
Residual current	≤ 0.1 mA
Isolation test voltage	≤ 0.5 kV
Short-circuit protection	yes / Cyclic
Voltage drop at I _o	≤ 1.8 V
Wire breakage/Reverse polarity protection	yes / Complete
Output function	3-wire, NO contact, PNP
Switching frequency	1 kHz
Mechanical data	
Design	Rectangular, IKT
Dimensions	30 x 14.6 x 28 mm
Housing material	Metal, GD-Zn
Active area material	Plastic, PA12-GF30

Functional principle

Magnetic field sensors are activated by magnetic fields and are especially suited for piston position detection in pneumatic cylinders. Based on the fact that magnetic fields can permeate non-magnetizable metals, it is possible to detect a permanent magnet attached to the piston through the aluminium wall of the cylinder.

Technical data

Electrical connection	Connector, M12 × 1
Environmental conditions	
Ambient temperature	-25...+70 °C
Vibration resistance	55 Hz (1 mm)
Shock resistance	30 g (11 ms)
Protection class	IP67
MTTF	2283 years acc. to SN 29500 (Ed. 99) 40 °C
Mounting on the following profiles	
Cylindrical design	○ ##
Switching state	LED, Yellow
Included in delivery	KLI3

Mounting instructions

Mounting instructions/Description



Accessories

KLI1 **69710**

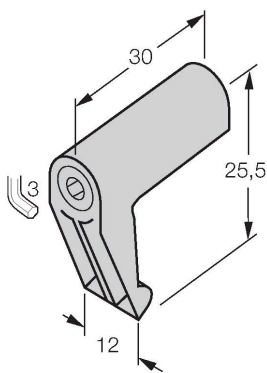

Mounting bracket for mounting magnetic field sensors on tie-rod cylinders; cylinder diameter: 32...100 mm; material: Die-cast Zinc

KLI3 **69712**

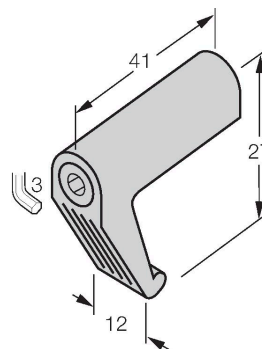

Mounting bracket for mounting magnetic field sensors on tie-rod cylinders; cylinder diameter: 63...160 mm; material: Die-cast Zinc

KLI5Z **6971803**

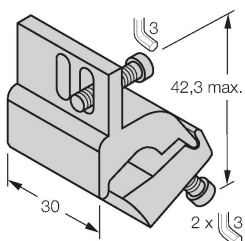

Mounting bracket for mounting magnetic field sensors on tie-rod cylinders; cylinder diameter: 32...63 mm; material: Aluminum

KLI6Z **6971806**

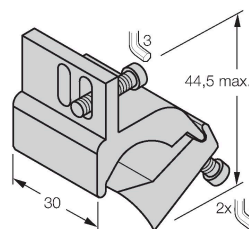

Mounting bracket for mounting magnetic field sensors on tie-rod cylinders; cylinder diameter: 50...125 mm; material: Aluminum

KL15

6971802

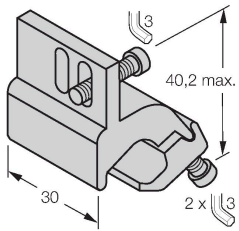

Mounting bracket for mounting magnetic field sensors on profile cylinders; cylinder diameter: 32...50 mm; material: Aluminum

KL16

6971805

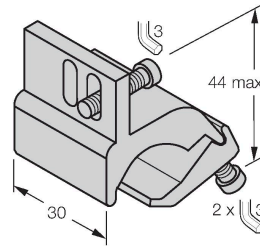

Mounting bracket for mounting magnetic field sensors on profile cylinders; cylinder diameter: 50...100 mm; material: Aluminum

KL17

6971810

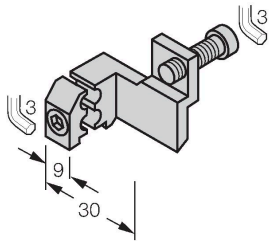

Mounting bracket for mounting magnetic field sensors on profile cylinders with external dovetail guide; cylinder diameter: 32...200 mm; material: Aluminum