

BIM-UNT-AP6X-0,3-PSG3S

Magnetic Field Sensor – For Pneumatic Cylinders

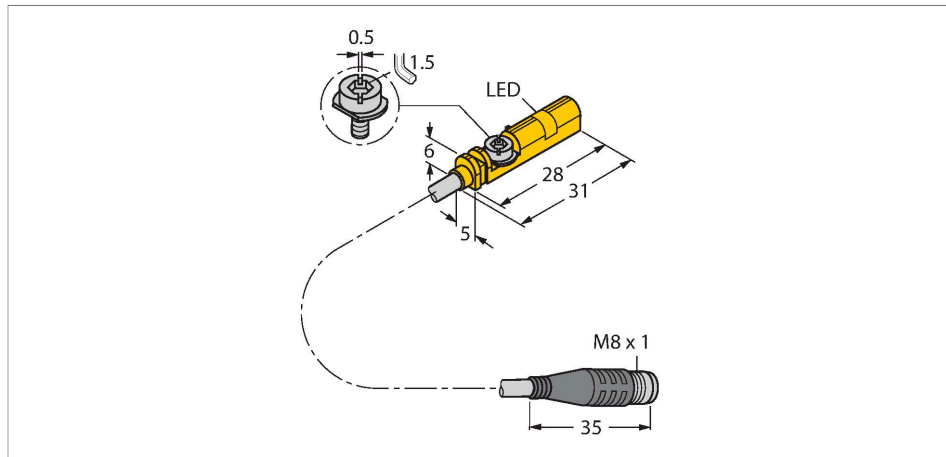

Features

- For T-groove cylinders without mounting accessories
- Optional accessories for mounting on other cylinder designs
- One-hand mounting possible
- Stable mounting
- Magneto-resistive sensor
- DC 3-wire, 10...30 VDC
- NO contact, PNP output
- Pigtail with male end, Ø 8 mm

Wiring diagram

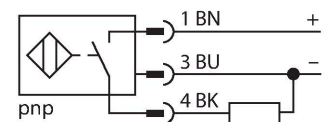

Technical data

Type	BIM-UNT-AP6X-0,3-PSG3S
ID	4685722
General data	
Pass speed	≤ 10 m/s
Repeatability	≤ ± 0.1 mm
Temperature drift	≤ 0.1 mm
Hysteresis	≤ 1 mm
Electrical data	
Operating voltage	10...30 VDC
Residual ripple	≤ 10 % U _{ss}
DC rated operational current	≤ 150 mA
No-load current	15 mA
Residual current	≤ 0.1 mA
Isolation test voltage	≤ 0.5 kV
Short-circuit protection	yes / Cyclic
Voltage drop at I _o	≤ 1.8 V
Wire breakage/Reverse polarity protection	yes / Complete
Output function	3-wire, NO contact, PNP
Switching frequency	1 kHz
Mechanical data	
Design	Rectangular, UNT
Dimensions	28 x 5 x 6 mm
Housing material	Plastic, PP
Active area material	Plastic, PP

Functional principle

Magnetic field sensors are activated by magnetic fields and are used, in particular, for the detection of the piston position in pneumatic cylinders. As magnetic fields can permeate non-magnetizable metals, they detect a permanent magnet attached to the piston through the aluminium cylinder wall.

Technical data

Tightening torque fixing screw	0.4 Nm
Electrical connection	Cable with connector, Ø 8 mm
Cable quality	Ø 3 mm, Gray, Lif9Y-11Y, PUR, 0.3 m
	Suited for E-ChainSystems® acc. to manufacturers declaration H1063M
Core cross-section	3 x 0.14 mm ²
Environmental conditions	
Ambient temperature	-25...+70 °C
Vibration resistance	55 Hz (1 mm)
Shock resistance	30 g (11 ms)
Protection class	IP68
MTTF	2283 years acc. to SN 29500 (Ed. 99) 40 °C
Mounting on the following profiles	
Cylindrical design	
Switching state	LED, Yellow
Included in delivery	cable clip

Mounting instructions

Mounting instructions/Description

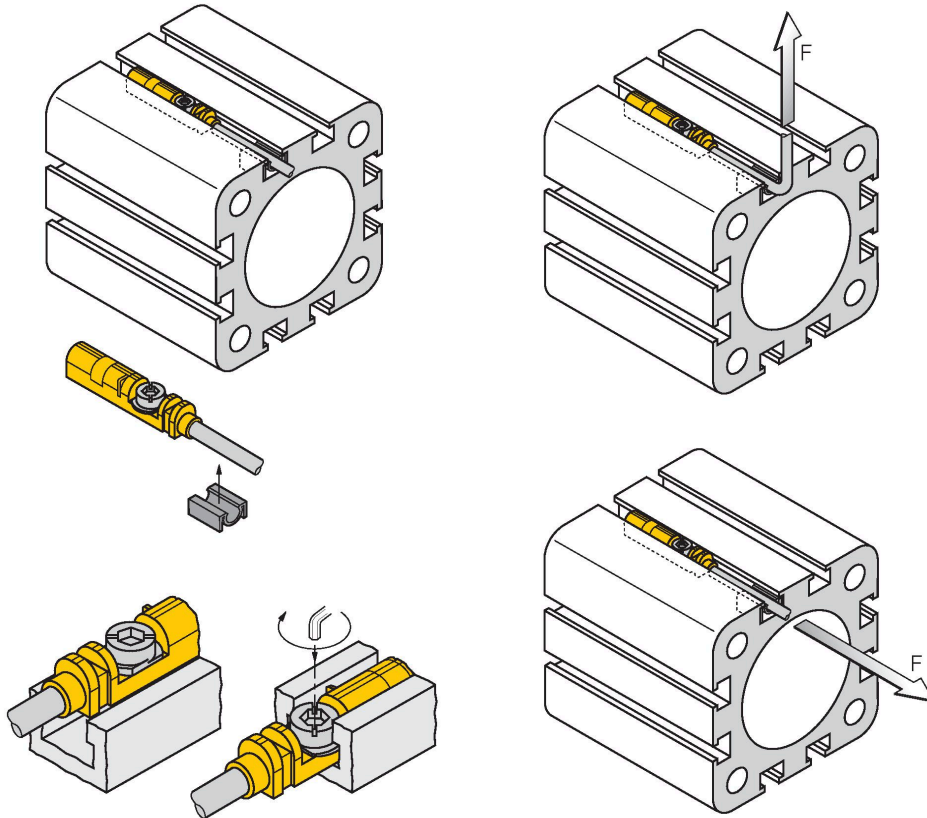

Thanks to the mounting lip, the sensor can be inserted into the groove from above with one hand. Mount the sensors as follows using the patented wing screw: The wing screw and the female thread feature a left-hand thread. Two small plastic lips keep the screw in position, ready-to-install. Turn the screw clockwise. The screw moves out of the thread and hits the upper grooves with the wings. The sensor is thus pressed down and locked in position. A few degrees up to approximately 1.5 turns of the screw with a slotted screwdriver (blade width 0.5 mm) or a 1.5 mm Allen key are sufficient to ensure vibration-proof fastening, depending on the shape of the slot. A tightening torque of 0.4 Nm is sufficient for safe mounting without damaging the cylinder. The sensor can now withstand an axial and radial tensile load of $F=100\text{N}$ applied on the cable. A cable clip is included in the scope of delivery. It enables smooth cable routing in the groove and ensures that the cable is fastened as securely as possible. The corresponding accessories for mounting on other cylindrical housings must be ordered separately.

Accessories

KLZCD2-UNT

6970418

Mounting bracket for mounting magnetic field sensors for T-grooves on a CleanDesign cylinder with mounting rail

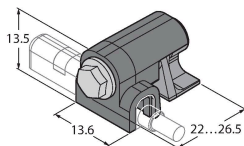

KLZ1-INT

6970410

Accessories for mounting the sensors BIM-INT and BIM-UNT on tie-rod cylinders; cylinder diameter: 32... 40 mm; material: Aluminum; further mounting accessories for other cylinder diameters on request

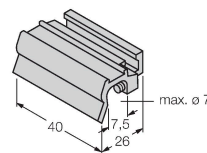

KLZ2-INT

6970411

Accessories for mounting the sensors BIM-INT and BIM-UNT on tie-rod cylinders; Cylinder diameter: 50... 63 mm; material: Aluminium; Further mounting accessories for other cylinder diameters on request

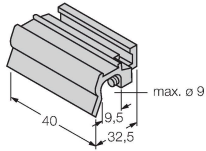

UNT-STOPPER

4685751

Accessories for finetuning the switchpoint on T-groove cylinders; snap-locked in the BIM-UNT fixture; suited for multiple use; material: plastic

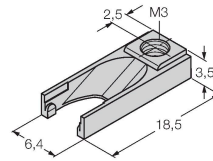

KLRC-UNT1

6970626

Mounting bracket for mounting magnetic field sensors on round cylinders; cylinder diameter: 8...25 mm; material: PA 6I/6T / nickel silver; fire-hazard classification acc. to UL94 - V2

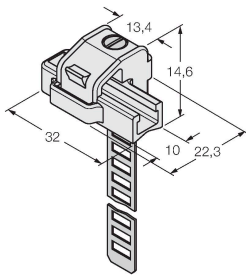

KLRC-UNT2

6970627

Mounting bracket for mounting magnetic field sensors on round cylinders; cylinder diameter: 25...63 mm; material: PA 6I/6T / nickel silver; fire-hazard classification acc. to UL94 - V2

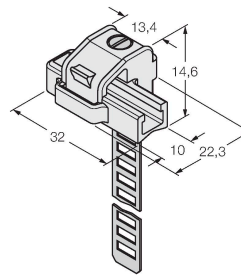

KLRC-UNT3

6970628

Mounting bracket for mounting magnetic field sensors on round cylinders; cylinder diameter: 63...130 mm; material: PA 6I/6T / nickel silver; fire-hazard classification acc. to UL94 - V2

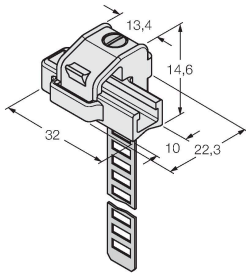

KLRC-UNT4

6970629

Mounting bracket for mounting magnetic field sensors on round cylinders; cylinder diameter: 130...250 mm; material: PA 6I/6T / nickel silver; fire-hazard classification acc. to UL94 - V2

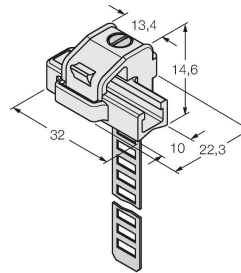

KLDT-UNT2

6913351

Mounting bracket for mounting magnetic field sensors on dovetail groove cylinders; groove width: 7 mm; material: PPS

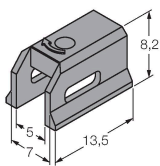

KLDT-UNT3

6913352

Mounting bracket for mounting magnetic field sensors on dovetail groove cylinders; groove width: 9.4 mm; material: PPS

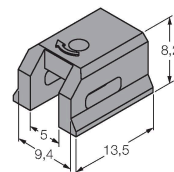

KLDT-UNT6

6913355

Mounting bracket for mounting magnetic field sensors on dovetail groove cylinders; groove width: 7.35 mm; material: PPS

