

# PT200PSIG-13-LI3-H1131

## Pressure Transmitter – With Current Output (2-Wire)

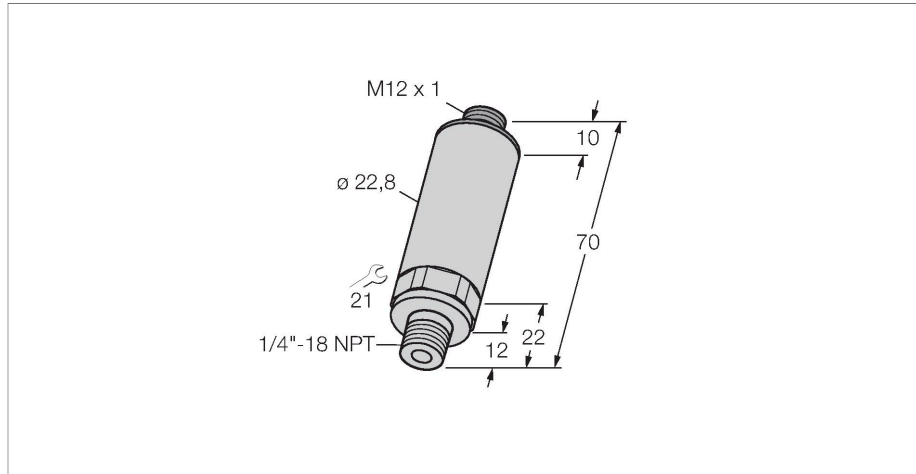

### Features

- Compact and robust design
- Pressure connection with integrated peak pressure aperture
- Minimum influence of temperature on accuracy within the entire temperature range of -40...+125°C
- Excellent EMC properties
- Pressure range 0...200 psi rel.

### Wiring diagram

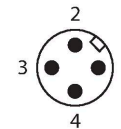
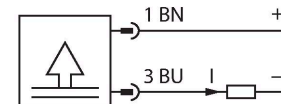

### Functional principle

The pressure transmitters of the PT...-1 series operate with piezo-resistive ceramic measuring cells. The ceramic diaphragm is unbalanced in proportion to the pressure applied. Depending on the sensor type used, the processed signal is provided as an analog output signal 4...20mA (2-wire) or 0...10V (3-wire).

### Technical data

Type	PT200PSIG-13-LI3-H1131
ID	6831460
Medium temperature	-40...+125 °C
<b>Pressure range</b>	
Pressure type	Relative pressure
Pressure range	0...13.79 bar
	0...200 psi
	0...1.38 MPa
Admissible overpressure	≤ 34.47 bar
Burst pressure	≥ 34.47 bar
Response time	< 2 ms, typ. 1 ms
Long-term stability	± 1 % FS, In accordance with DIN EN 60770
<b>Power supply</b>	
Operating voltage	8...33 VDC
Current consumption	≤ 20 mA
Protective measure	SELV according to EN 50178
Short-circuit/reverse polarity protection	yes / yes
Insulation class	III
<b>Outputs</b>	
Output 1	Analog output
Output function	Analog output current
<b>Analog output</b>	
Current output	4...20 mA

## Technical data

Load	$\leq 1 \text{ k}\Omega$
Resolution	$<\pm 0.1 \text{ \% FS}$
Accuracy LHR	$\pm 0.3 \text{ \% FS BSL}$
Calibration accuracy 0-point	0.3 % FS
Calibration accuracy full scale	0.3 % FS
<b>Mechanical data</b>	
Housing material	Stainless-steel/Plastic, 1.4305 (AISI 303)
Process connection	1/4" NPT-18 male thread
Pressure connection material	Stainless steel 1.4305 (AISI 303)
Pressure transducer material	Ceramic $\text{Al}_2\text{O}_3$
Sealing material	FPM
Wrench size pressure connection / coupling nut	SW 21
Max. tightening torque of housing nut	20 Nm
Electrical connection	Connector, M12 × 1
Protection class	IP67
<b>Environmental conditions</b>	
Ambient temperature	-40...+85 °C
Storage temperature	-40...+85 °C
Shock resistance	100 g (11 ms) acc. to IEC 68-2-27
Vibration resistance	20 x g (9...2000 Hz, 2...9 Hz with an amplitude +/-15 mm), acc. to IEC 68-2-6
<b>Tests/approvals</b>	
Reference conditions acc. to IEC 61298-1	
Temperature	15...+25 °C
Atmospheric pressure	860...1060 hPa abs.
Humidity	45...75 % rel.
Auxiliary power	24 VDC
<b>Temperature behaviour</b>	
Temperature coefficient range $\text{TK}_s$	$\pm 0.15 \text{ \% of full scale/10 K}$
Temperature coefficient zero point $\text{TK}_0$	$\pm 0.15 \text{ \% of full scale/10 K}$
MTTF	114 years acc. to SN 29500 (Ed. 99) 40 °C
<b>Technical data</b>	
Type	PT200PSIG-13-LI3-H1131
ID	6831460
<b>Pressure range</b>	
Pressure type	Relative pressure

## Technical data

Pressure range	0...13.79 bar
	0...200 psi
	0...1.38 MPa
Admissible overpressure	≤ 34.47 bar
Burst pressure	≥ 34.47 bar
Response time	< 2 ms, typ. 1 ms
Long-term stability	1 % FS, In accordance with DIN EN 60770
<b>Power supply</b>	
Operating voltage	8...33 VDC
Current consumption	≤ 20 mA
Protective measure	SELV according to EN 50178
Short-circuit/reverse polarity protection	yes / yes
Protection type and class	IP67 / III
Insulation voltage	500 VDC
<b>Outputs</b>	
Output 1	Analog output
Output function	Analog output current
<b>Analog output</b>	
Current output	4...20 mA
Load	≤ 1 kΩ
Resolution	<± 0.1 % FS
Accuracy LHR	± 0.3 % FS BSL
Calibration accuracy 0-point	0.3 % FS
Calibration accuracy full scale	0.3 % FS
<b>Temperature behaviour</b>	
Medium temperature	-40...+125 °C
Temperature coefficient zero point TK <sub>0</sub>	± 0.15 % of full scale/10 K
Temperature coefficient range TK <sub>s</sub>	± 0.15 % of full scale/10 K
<b>Environmental conditions</b>	
Ambient temperature	-40...+85 °C
Storage temperature	-40...+85 °C
Vibration resistance	20 x g (9...2000 Hz, 2...9 Hz with an amplitude +/-15 mm), acc. to IEC 68-2-6
Shock resistance	100 g (11 ms) acc. to IEC 68-2-27
<b>Mechanical data</b>	
Housing material	Stainless-steel/Plastic, 1.4305 (AISI 303)
Pressure connection material	Stainless steel 1.4305 (AISI 303)
Pressure transducer material	Ceramic Al <sub>2</sub> O <sub>3</sub>

## Technical data

Sealing material	FPM
Process connection	1/4" NPT-18 male thread
Wrench size pressure connection / coupling nut	SW 21
Electrical connection	Connector, M12 × 1
Max. tightening torque of housing nut	20 Nm
<b>Reference conditions acc. to IEC 61298-1</b>	
Temperature	15...+25 °C
Atmospheric pressure	860...1060 hPa abs.
Humidity	45...75 % rel.
Auxiliary power	24 VDC
<b>Tests/approvals</b>	
MTTF	114 years acc. to SN 29500 (Ed. 99) 40 °C