

PC010V-203-2UPN8X-H1141

Pressure Sensor – 2 PNP/NPN Transistor Switching Outputs

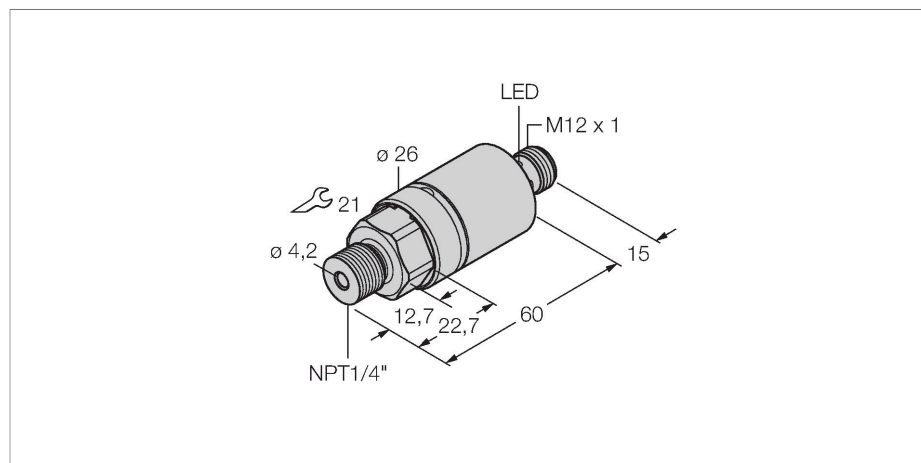

Features

- Cylindrical version without display
- 2 PNP/NPN switching outputs
- Communication via IO-Link
- Display of communication via LED at M12 connector
- Pressure range -1...10 bar rel.

Wiring diagram

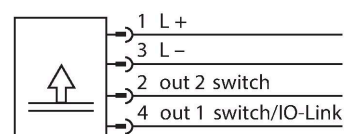

Technical data

Type	PC010V-203-2UPN8X-H1141
ID	6833741
Medium temperature	-40...+85 °C
Pressure range	
Pressure type	Relative pressure
Pressure range	-1...10 bar
	-14.5...145.04 psi
	-0.1...1 MPa
Admissible overpressure	≤ 50 bar
Burst pressure	≥ 50 bar
Response time	< 3 ms
Power supply	
Operating voltage	15...30 VDC
Current consumption	≤ 12 mA
Protective measure	SELV; PELV according to EN 50178
Short-circuit/reverse polarity protection	yes / yes
Insulation class	III
Outputs	
Output 1	Switching output or IO-Link mode
Output 2	Switching output
Switching output	
Communication protocol	IO-Link
Output function	NO/NC, PNP/NPN
Accuracy	± 0.5 % FS BSL

Functional principle

The IO-Link pressure transmitters of the PC 200 series operate with piezoresistive ceramic measuring cells. The ceramic diaphragm is unbalanced in proportion to the pressure applied. The digitally processed signal is made available via IO-Link or as switching output. Highest flexibility and 0.5 % f.s. accuracy guarantee secure connection to your processes.

Technical data

Rated operational current	0.15 A
Switching frequency	≤ 180 Hz
Switching point distance	≥ 0.5 %
Switch point:	(Min. + 0.005 × range)...100 % of full scale
Release point(s)	min up to (SP - 0.005 x range)
Switching cycles	≥ 100 mil.
IO-Link	
IO-Link specification	V 1.0
Transmission physics	corresponds to 3-wire physics (PHY2)
Frame type	2.2
Transmission rate	COM 2 / 38.4 kbps
Process data width	16 bit
Measured value information	14 bit
Switchpoint information	2 bit
Programming	FDT / DTM
Accuracy	± 0.5 % FS BSL
Included in the SIDI GSDML	Yes
Programming options	switch/release point, PNP/NPN, NO/NC, hysteresis/window mode, muting, pressure unit, peak pressure memory
Mechanical data	
Housing material	Stainless steel, 1.4305 (AISI 303)/PBT-GF15
Process connection	1/4" NPT-18 male thread
Pressure connection material	Stainless steel 1.4305 (AISI 303)
Pressure transducer material	Ceramic Al ₂ O ₃
Sealing material	FPM
Wrench size pressure connection / coupling nut	21
Electrical connection	Connector, M12 × 1
Protection class	IP67 IP69K
Environmental conditions	
Ambient temperature	-40...+80 °C
Storage temperature	-40...+80 °C
Shock resistance	50 acc. to IEC 68-2-27
Vibration resistance	20 g (9...2000 Hz), according to IEC 68-2-6

Technical data

Tests/approvals	
Reference conditions acc. to IEC 61298-1	
Temperature	15...+25 °C
Atmospheric pressure	860...1060 hPa abs.
Humidity	45...75 % rel.
Auxiliary power	24 VDC
Temperature behaviour	
Temperature coefficient range TK _s	± 0.15 % of full scale/10 K
Temperature coefficient zero point TK ₀	± 0.15 % of full scale/10 K
MTTF	2079 years acc. to SN 29500 (Ed. 99) 40 °C

Technical data

Type	PC010V-203-2UPN8X-H1141
ID	6833741
Pressure range	
Pressure type	Relative pressure
Pressure range	-1...10 bar
	-14.5...145.04 psi
	-0.1...1 MPa
Admissible overpressure	≤ 50 bar
Burst pressure	≥ 50 bar
Response time	< 3 ms
Power supply	
Operating voltage	15...30 VDC
Current consumption	≤ 12 mA
Voltage drop at I _o	≤ 2 V
Protective measure	SELV; PELV according to EN 50178
Short-circuit/reverse polarity protection	yes / yes
Protection type and class	IP67 IP69K / III
Outputs	
Output 1	Switching output or IO-Link mode
Output 2	Switching output
Switching output	
Communication protocol	IO-Link
Output function	NO/NC, PNP/NPN
Accuracy	± 0.5 % FS BSL

Technical data

Rated operational current	0.15 A
Switching frequency	≤ 180 Hz
Switching point distance	≥ 0.5 %
Switch point:	(Min. + 0.005 × range)...100 % of full scale
Release point(s)	min up to (SP - 0.005 x range)
Switching cycles	≥ 100 mil.
Switch point SP1	configurable
Release point rP1	customized
IO-Link	
IO-Link specification	V 1.0
Programming	FDT / DTM
Transmission physics	corresponds to 3-wire physics (PHY2)
Transmission rate	COM 2 / 38.4 kbps
Process data width	16 bit
Measured value information	14 bit
Switchpoint information	2 bit
Frame type	2.2
Accuracy	± 0.5 % FS BSL
Included in the SIDI GSDML	Yes
Temperature behaviour	
Medium temperature	-40...+85 °C
Temperature coefficient zero point TK ₀	± 0.15 % of full scale/10 K
Temperature coefficient range TK _s	± 0.15 % of full scale/10 K
Environmental conditions	
Ambient temperature	-40...+80 °C
Storage temperature	-40...+80 °C
Vibration resistance	20 g (9...2000 Hz), according to IEC 68-2-6
Shock resistance	50 acc. to IEC 68-2-27
Mechanical data	
Housing material	Stainless steel, 1.4305 (AISI 303)/PBT-GF15
Pressure connection material	Stainless steel 1.4305 (AISI 303)
Pressure transducer material	Ceramic Al ₂ O ₃
Sealing material	FPM
Process connection	1/4" NPT-18 male thread
Wrench size pressure connection / coupling nut	21

Technical data

Electrical connection	Connector, M12 × 1
Reference conditions acc. to IEC 61298-1	
Temperature	15...+25 °C
Atmospheric pressure	860...1060 hPa abs.
Humidity	45...75 % rel.
Auxiliary power	24 VDC
Programming options	switch/release point, PNP/NPN, NO/NC, hysteresis/window mode, muting, pressure unit, peak pressure memory
Tests/approvals	
MTTF	2079 years acc. to SN 29500 (Ed. 99) 40 °C