

PS010D-501T-2UPN8X-H1141

Differential Pressure Sensor – 2 PNP/NPN Transistor Switching Outputs

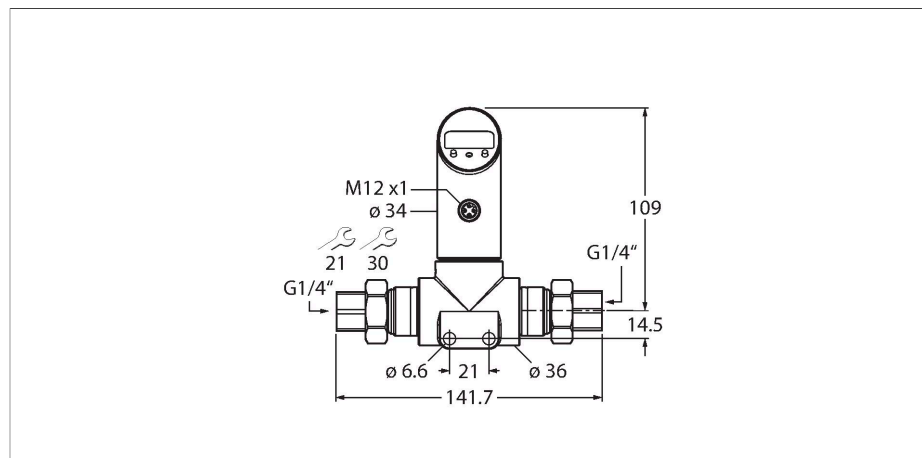

Features

- Pressure monitoring in harsh industrial environments
- Housing is rotatable after plugging the process connection
- Reading of adjusted values without tool
- High-side switch
- Recessed pushbutton, keylock and password for secure programming
- Permanent indication of pressure (bar, psi, kPa, MPa, misc)
- Peak pressure memory
- Pressure range 0...10 bar diff.

Wiring diagram

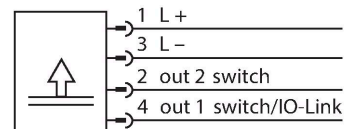

Functional principle

The PSD differential pressure sensors have two pressure connections with ceramic measuring cells to detect different pressures, from which the difference is formed. As a result of the pressure acting on the measuring cells, a signal that is proportional to the pressure is generated and electronically processed internally. Depending on the sensor variant, either switching or analog signals are available. All PSD variants have IO-Link. The PSD sensors operate in various positive pressure ranges up to a differential of 250 bar. The connection with higher pressure can be configured via the menu (High-Site-Switch).

Technical data

Type	PS010D-501T-2UPN8X-H1141
ID	6834108
Medium temperature	-40...+85 °C
Pressure range	
Pressure type	Differential Pressure
Pressure range	0...10 bar
	0...145.04 psi
	0...1 MPa
Admissible overpressure	≤ 50 bar
Burst pressure	≥ 50 bar
Response time	< 3 ms
Power supply	
Operating voltage	18...30 VDC
Current consumption	≤ 50 mA
Protective measure	SELV; PELV according to EN 50178
Short-circuit/reverse polarity protection	yes / yes
Insulation class	III
Outputs	
Output 1	Switching output or IO-Link mode
Output 2	Switching output
Switching output	
Communication protocol	IO-Link
Output function	NO/NC, PNP/NPN

Technical data

Accuracy	± 1 % FS BSL
Rated operational current	0.2 A
Switching frequency	≤ 180 Hz
Switching point distance	≥ 0.5 %
Switch point:	(Min. + 0.005 × range)...100 % of full scale
Release point(s)	min. up to (SP - 0.005 × range)
Switching cycles	≥ 100 mil.
Included in the SIDI GSDML	Yes
Programming options	Switching/reversing points; PNP/NPN; opener/closer; hysteresis/window mode; damping; pressure unit; printhead memory
Mechanical data	
Housing material	Stainless-steel/Plastic, 1.4305 (AISI 303)
Process connection	G 1/4" female thread
Pressure connection material	Stainless steel 1.4305 (AISI 303)
Pressure transducer material	Ceramic Al ₂ O ₃
Sealing material	FPM spez.
Wrench size pressure connection / coupling nut	21/ 30
Max. tightening torque of housing nut	35 Nm
Electrical connection	Connector, M12 × 1
Protection class	IP67 IP69K
Environmental conditions	
Ambient temperature	-40...+80 °C
Storage temperature	-40...+80 °C
Shock resistance	50 g (11 ms) acc. to IEC 60068-2-27
Vibration resistance	20 g (9...2000 Hz), according to IEC 60068-2-6
EMV	EN 61000-4-2 ESD: 4 kV CD/8 kV AD EN 61000-4-3 HF Radiated: 15 V/m EN 61000-4-4 Burst: 2 kV EN 61000-4-5 Surge: 1 kV, 42 Ohm EN 61000-4-6 HF Cable-bound: 10 V
Tests/approvals	
Reference conditions acc. to IEC 61298-1	
Temperature	15...+25 °C
Atmospheric pressure	860...1060 hPa abs.
Humidity	45...75 % rel.

Technical data

Auxiliary power	24 VDC
Display	4-digit 7-segment display, rotatable by 180°, with switch-off function
Switching state	2 × LEDs, Yellow
Unit display	5 x LEDs green (bar, psi, kPa, MPa, misc)
Temperature behaviour	
Temperature coefficient range TK _s	± 0.3 % of full scale/10 K
Temperature coefficient zero point TK ₀	± 0.3 % of full scale/10 K
MTTF	439 years

Technical data

Type	PS010D-501T-2UPN8X-H1141
ID	6834108
Pressure range	
Pressure type	Differential Pressure
Pressure range	0...10 bar
	0...145.04 psi
	0...1 MPa
Admissible overpressure	≤ 50 bar
Burst pressure	≥ 50 bar
Response time	< 3 ms
Power supply	
Operating voltage	18...30 VDC
Current consumption	≤ 50 mA
Voltage drop at I ₀	≤ 2.5 V
Protective measure	SELV; PELV according to EN 50178
Short-circuit/reverse polarity protection	yes / yes
Protection type and class	IP67 IP69K / III
Outputs	
Output 1	Switching output or IO-Link mode
Output 2	Switching output
Switching output	
Communication protocol	IO-Link
Output function	NO/NC, PNP/NPN
Accuracy	± 1 % FS BSL
Rated operational current	0.2 A
Switching frequency	≤ 180 Hz

Technical data

Switching point distance	≥ 0.5 %
Switch point:	(Min. + 0.005 × range)...100 % of full scale
Release point(s)	min. up to (SP - 0.005 × range)
Switching cycles	≥ 100 mil.
Included in the SIDI GSDML	Yes
Temperature behaviour	
Medium temperature	-40...+85 °C
Temperature coefficient zero point TK ₀	± 0.3 % of full scale/10 K
Temperature coefficient range TK _s	± 0.3 % of full scale/10 K
Environmental conditions	
Ambient temperature	-40...+80 °C
Storage temperature	-40...+80 °C
Vibration resistance	20 g (9...2000 Hz), according to IEC 60068-2-6
Shock resistance	50 g (11 ms) acc. to IEC 60068-2-27
EMV	EN 61000-4-2 ESD: 4 kV CD/8 kV AD EN 61000-4-3 HF Radiated: 15 V/m EN 61000-4-4 Burst: 2 kV EN 61000-4-5 Surge: 1 kV, 42 Ohm EN 61000-4-6 HF Cable-bound: 10 V
Mechanical data	
Housing material	Stainless-steel/Plastic, 1.4305 (AISI 303)
Pressure connection material	Stainless steel 1.4305 (AISI 303)
Pressure transducer material	Ceramic Al ₂ O ₃
Sealing material	FPM spez.
Process connection	G 1/4" female thread
Wrench size pressure connection / coupling nut	21/ 30
Electrical connection	Connector, M12 × 1
Max. tightening torque of housing nut	35 Nm
Reference conditions acc. to IEC 61298-1	
Temperature	15...+25 °C
Atmospheric pressure	860...1060 hPa abs.
Humidity	45...75 % rel.
Auxiliary power	24 VDC
Display	4-digit 7-segment display, rotatable by 180°, with switch-off function
Switching state	2 × LEDs, Yellow
Unit display	5 × LEDs green (bar, psi, kPa, MPa, misc)

Technical data

Programming options

Switching/reversing points; PNP/NPN;
opener/closer; hysteresis/window mode;
damping; pressure unit; printhead
memory

Tests/approvals

MTTF

439 years
