

Compact IP20 Multiprotocol Ethernet I/O Station

4 Digital PNP Inputs and 4 Configurable Digital PNP Channels

FEN20-4DIP-4DXP-DIN

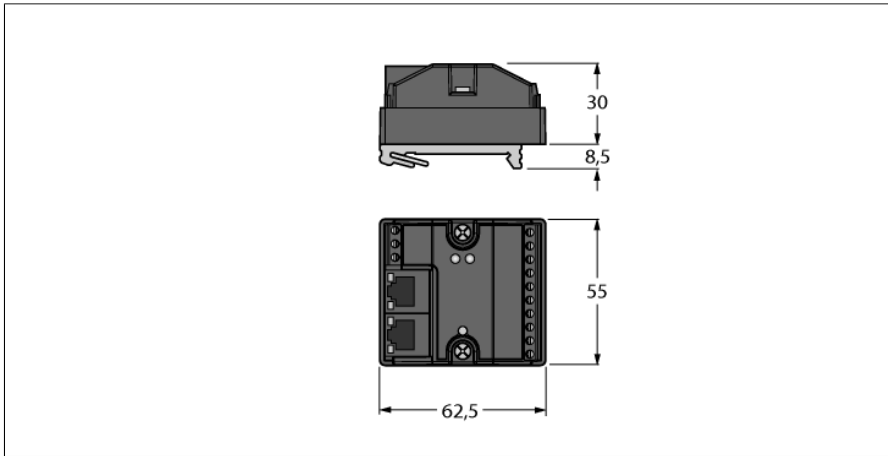

- EtherNet/IP™ Slave
- Modbus TCP Slave
- PROFINET Slave
- Integrated Ethernet Switch
- 10 Mbps / 100 Mbps supported
- 2 x RJ45 Sockets for Fieldbus Connection
- Can be mounted on DIN rail
- 4 digital PNP inputs
- 4 configurable PNP channels, DI or DO
- 24 VDC
- 1 A outputs
- Protection class IP20

Type	FEN20-4DIP-4DXP-DIN
ID	6931092
<hr/>	
Number of channels	8
Operating / load voltage	12...30 VDC
Operating current	100 mA
Electrical isolation	500V Galvanic Zone-Zone and Zone-Ethernet
Supply voltage	24 VDC
Power dissipation, typical	≤ 2.4 W
Voltage supply connection	Screw terminals
<hr/>	
Inputs	
Number of channels	8
Input voltage	24 VDC
Supply current	700 mA
Switching threshold	7V / 1.65mA
Low level signal voltage	< 7 VDC
High level signal voltage	7...30 VDC
Low level signal current	< 1.5 mA
High level signal current	> 2 mA
Input delay	2.5 ms
Max. input current	6 mA
<hr/>	
Outputs	
Number of channels	4
Output voltage	12...30 VDC
Output current per channel	1 A
Output total current	4 A
Load type	Resistive, Inductive, Lamp Load
Short-circuit protection	yes





System data	
Transmission rate	10/100 Mbps; Full/Half Duplex; Auto Negotiation; Auto Crossing
Addressing modes Ethernet:	via Software
Connection technology Ethernet	2 × RJ45 female connector
Protocol detection	automatic
Web server	192.168.1.254 (Default)
Service interface	Ethernet
Device Reset	via Push-button

Modbus TCP	
Addressing	Static IP, BOOTP, DHCP
Supported function codes	FC1, FC2, FC3, FC4, FC5, FC6, FC15, FC16, FC23
Number of TCP connections	6
Input Data Size	max. 1 register
Input register start address	0 (0x0000 hex)
Output Data Size	max. 1 register
Output register start address	2048 (0x0800 hex)

Ethernet/IP	
Addressing	acc. to EtherNet/IP specification
Quick Connect (QC)	< 150 ms
Device Level Ring (DLR)	supported
Class 1 connections (CIP)	6

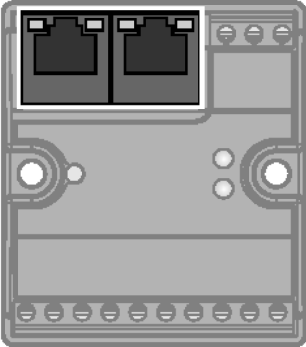
PROFINET	
Addressing	DCP
Conformance class	B (RT)
MinCycleTime	1 ms
Fast Start-Up (FSU)	< 150 ms
Diagnostics	acc. to PROFINET alarm handling
Topology detection	supported
Automatic addressing	supported
Media Redundancy Protocol (MRP)	supported

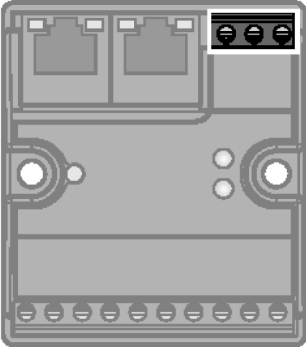
Dimensions (W x L x H)	55 x 62.5 x 30 mm
Housing material	Fiber-glass reinforced Polyamide (PA6-GF30)
Ambient temperature	-40...+70 °C
Storage temperature	-40...+85 °C
Vibration test	Acc. to IEC 60068-2-6
Shock test	Acc. to IEC 60068-2-27
Protection class	IP20
MTTF	459 years acc. to SN 29500 (Ed. 99) 20 °C
Approvals	CE, cULus, Class I, Div. 2

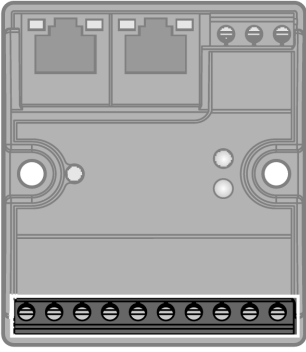
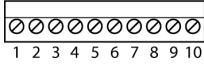
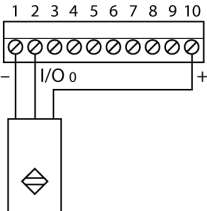
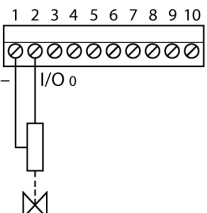
	<p>Ethernet Fieldbus cable (example): RJ45S RJ45S 441-2M (Ident no. U-06842)</p>	<p>RJ45 Ethernet</p>  <p>12345678</p> <ul style="list-style-type: none"> 1 = TX + 2 = TX - 3 = RX + 4 = n.c. 5 = n.c. 6 = RX - 7 = n.c. 8 = n.c.
	<p>Power Supply Recommended torque for screw terminals: 0.5 Nm (4.43 lb.in)</p>	<p>Power Supply</p>  <p>1 2 3</p> <ul style="list-style-type: none"> 1 = ⊖ 2 = V1 - 3 = V1 +
	<p>I/O Channels Recommended torque for screw terminals: 0.5 Nm (4.43 lb.in)</p>	<p>Terminal Connection</p>  <p>1 2 3 4 5 6 7 8 9 10</p> <ul style="list-style-type: none"> 1 = V1 - 2 = I/O 0 3 = I/O 1 4 = I/O 2 5 = I/O 3 6 = I 4 7 = I 5 8 = I 6 9 = I 7 10 = V_{OUT} 1 + <p>3-wire</p>  <p>2-wire</p> 

Module LED Status

LED	Color	Status	Description
ETH1 / ETH2	Green	ON	Ethernet Link (100 Mbps)
		Flashing	Ethernet communication (100 Mbps)
	yellow	ON	Ethernet Link (10 Mbps)
		Flashing	Ethernet communication (10 Mbps)
		OFF	No Ethernet link
BUS	Green	ON	Active connection to a master
		flashing	operational
		flashing 3 × (1Hz)	ARGEE program running
	Red	ON	IP address conflict or status word active
		Flashing	Blink/Wink command active
		OFF	No power supply
Red/Green	Flashing (1Hz)	Assign IP address	
ERR	Green	ON	Diagnostics disabled
	Red	ON	Short-circuit

Process Data Mapping

Modbus TCP Register Mapping

	Reg	Bit 15	Bit 14	Bit 13	Bit 12	Bit 11	Bit 10	Bit 9	Bit 8	Bit 7	Bit 6	Bit 5	Bit 4	Bit 3	Bit 2	Bit 1	Bit 0
Inputs (RO)	0x0000	-	-	-	-	-	-	-	-	DI7	DI6	DI5	DI4	DI3	DI2	DI1	DI0
Status (RO)	0x0001	-	FCE	-	-	CFG	COM	V1 low	-	-	-	-	-	-	-	-	Diag Warn
Diag (RO)	0x0002	-	-	-	-	-	-	-	-	-	-	-	-	-	-	-	I/O Diag
Outputs (RW)	0x0800	-	-	-	-	-	-	-	-	-	-	-	-	DO3	DO2	DO1	DO0
I/O Diag (RO)	0xA000	-	-	-	-	SCO3	SCO2	SCO1	SCO0	-	-	-	-	-	-	-	IGS

EtherNet/IP™ Data Mapping

INPUT	Word	Bit 15	Bit 14	Bit 13	Bit 12	Bit 11	Bit 10	Bit 9	Bit 8	Bit 7	Bit 6	Bit 5	Bit 4	Bit 3	Bit 2	Bit 1	Bit 0
	0	-	FCE	-	-	CFG	COM	V1 low	-	-	-	-	-	-	-	-	Diag Warn
	1	-	-	-	-	-	-	-	-	DI7	DI6	DI5	DI4	DI3	DI2	DI1	DI0
	2	-	-	Sched Diag	-	-	-	-	-	-	-	-	-	-	-	-	I/O Diag
	3	-	-	-	-	SCO3	SCO2	SCO1	SCO0	-	-	-	-	-	-	-	IGS
OUTPUT	Word	Bit 15	Bit 14	Bit 13	Bit 12	Bit 11	Bit 10	Bit 9	Bit 8	Bit 7	Bit 6	Bit 5	Bit 4	Bit 3	Bit 2	Bit 1	Bit 0
	0	-	-	-	-	-	-	-	-	-	-	-	-	-	-	-	-
	1	-	-	-	-	-	-	-	-	-	-	-	-	DO3	DO2	DO1	DO0

PROFINET Process Data

	Byte	Bit 7	Bit 6	Bit 5	Bit 4	Bit 3	Bit 2	Bit 1	Bit 0
Inputs	0	DI7	DI6	DI5	DI4	DI3	DI2	DI1	DI0
	1	-	-	-	-	-	-	-	-
Outputs	0	-	-	-	-	DO3	DO2	DO1	DO0
	1	-	-	-	-	-	-	-	-

Key:

DIx	Digital input x	COM	Communication error on internal module bus
DOx	Digital output x	CFG	I/O configuration error
IGS	Input group short-circuit	FCE	I/O-ASSISTANT Force Mode active
SCOx	Short-circuit output x	I/O Diag	I/O diagnostic detected
Diag Warn	Diagnostic at least on 1 channel	Sched Diag	Manufacturer-specific diagnostics configured and active
V1 low	Undervoltage V1	-	-