

Accessories

Mounting Clamp

BST-30N

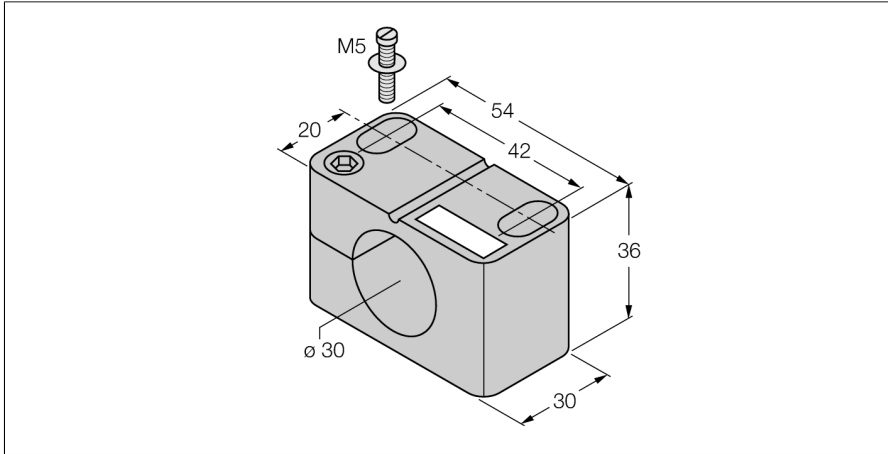

- Fixing clamp without dead-stop
- Plastic PA6

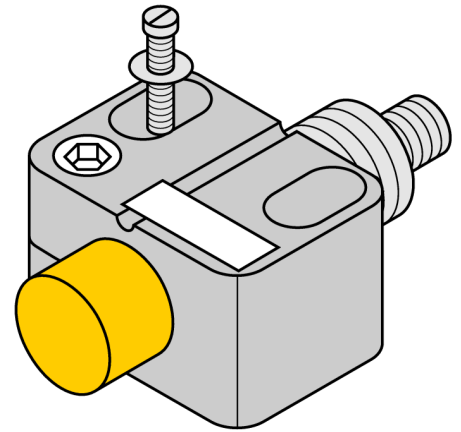

Type	BST-30N
ID	6947217
Design	Accessories for threaded barrels, M30
Dimensions	30 x 54 x 36 mm
Housing material	Plastic, PA6, Black
Max. tightening torque of housing nut	1 Nm