

WK 4.21T-x Actuator and Sensor Cable – Connection Cable

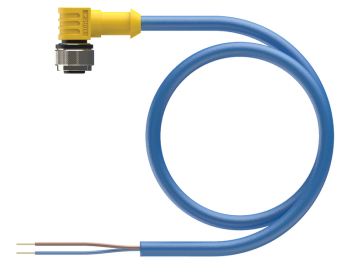
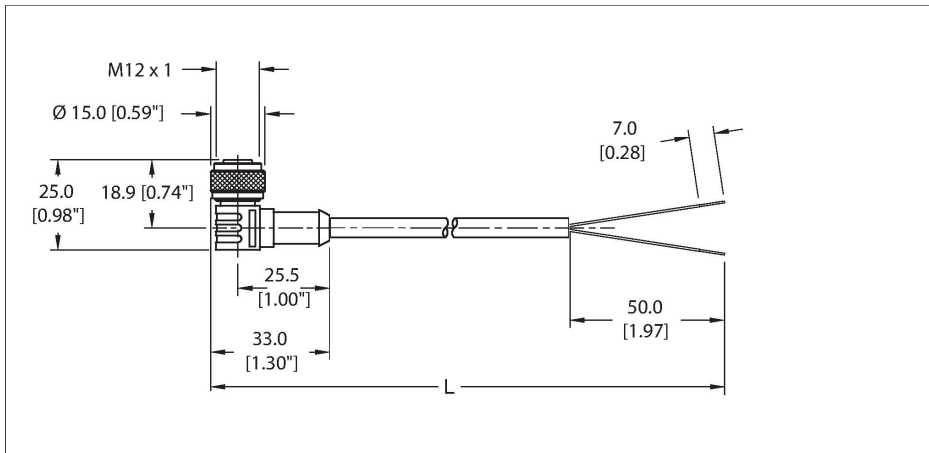

Technische Daten

Type	WK 4.21T-x
ID	777000682
Connector A	Female, M12 × 1, Right angle, A-code
Design specification	Acc. to IEC 61076-2-101
Number of contacts	4
Contacts	Brass, CuZn, Gold-plated
Contact carriers	Plastic, Nylon or TPU, Black
Connector body	Plastic, TPU, Yellow
Coupling nut	Brass, CuZn, Nickel-plated
Connector seal	O-ring, Plastic, FKM/FPM
Tightening torque (range)	0.8 ... 1 Nm (note max. torque of mating connector!)
Mechanical life	> 100 Mating cycles
Pollution degree	3
Protection class (When coupled)	IP68, IP69K
	NEMA: 1, 3, 4, 6P
Cable data	
Cable ID	RF51923
Total number of conductors	2
Cable diameter	Ø 5.13 mm
Cable jacket	PVC, Blue
Conductor diameter	0.061 "
Conductor material	TC (tinned copper)
Conductor insulation material	PVC
Conductor size	2 x 20 AWG [Similar to 0.50 mm ²]

Features



- Right angle Female M12 eurofast Connector
- M12, Female, Right angle, 2-pin
- Instrumentation Tray Cable
- Blue PVC jacket, 2X20 AWG
- Sunlight Resistant
- -40 Cold Bend Rating
- Oil Resistant
- Flame Ratings: UL 1685 FT4, UL1061, CSA FT4
- Flexlife® and C-Track Approved

Cable cross section

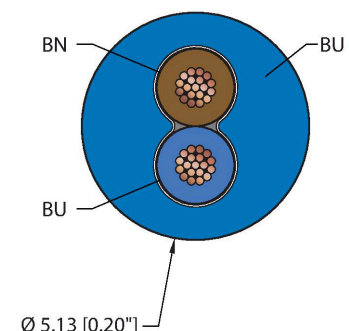

Contact assignment

Technische Daten

Number of strands x O.D.	19 x 0.0073 "
Conductor colors	BN, BU
Electrical properties at +20 °C	
Rated voltage	250 V
Current	4 A
Mechanical and chemical properties	
Bending radius (static)	≥ 5 x Ø
Bending radius (dynamic)	≥ 10 x Ø
Torsion rating	Max. 20 million
UL cold bend rating	-40 °C
Flex rating 10 x Ø	20 million cycles
	*When correctly installed at 20 °C, 50 % RH.
C-Track	Yes
Ambient temperature range (static)	-40...+90 °C
Ambient temperature range (dynamic)	5...+90 °C
Temperature range (installation)	-10...+90 °C
Approval	
Approvals	UL 2238 CSA C22.2 No. 182.3 CE UKCA RoHS

Note

- Flex ratings may be reduced if used in extreme temperatures, exposure to certain chemicals, operating above the rated cycle speed, or operating below the rated cable bend radius.

- We reserve the right to make technical alterations without prior notice.

Connector A

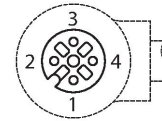

Circuit Diagram

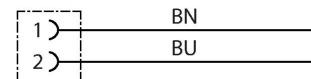

Montagezubehör

TORQUE-WRENCH-SET-M12-LEGACY

A900153

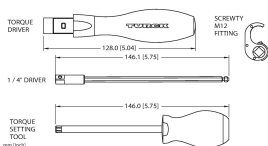

Adjustable torque driver to connect to a Ø15mm knurl. Compatible with the redesigned and legacy M12 cordsets. Includes (1) adjustable torque driver, (1) adjustment tool, (1) 1/4" square to 4mm hex adaptor bit, and (1) Ø15mm spring loaded clamp bit

Montagezubehör

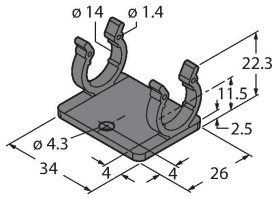
M12-CORDSETS-MOUNTING-CLIP-(10/BAG)**100016882**

10 Pack of black mounting clips and M4x8mm mounting screws, used to secure cable to cable connection points.