

# RK 4.4T-x-PSG 4M

## Actuator and Sensor Cable – Extension Cable

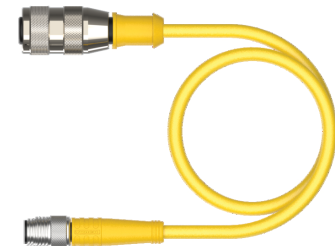
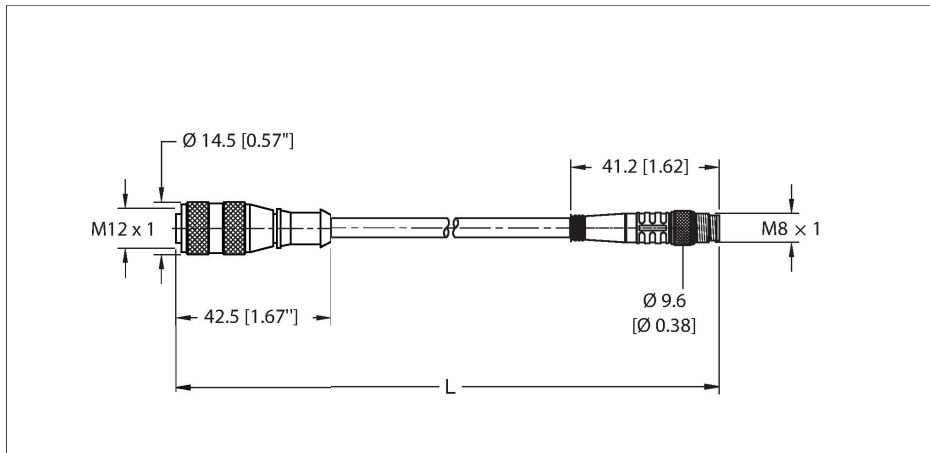

### Technische Daten

|                                 |   |
|---------------------------------|---|
| Type                            | RK 4.4T-x-PSG 4M  |
| ID                              | 777002577   |
| Connector A                     | Female, M12 × 1, Straight, A-code                         |
| Design specification            | Acc. to IEC 61076-2-101                                   |
| Number of contacts              | 4   |
| Contacts                        | Brass, CuZn, Gold-plated                                  |
| Contact carriers                | Plastic, Nylon or TPU, Black                              |
| Connector body                  | Plastic, TPU, Yellow                                      |
| Coupling nut                    | Brass, CuZn, Nickel-plated                                |
| Connector seal                  | O-ring, Plastic, FKM/FPM                                  |
| Tightening torque (range)       | 0.8 ... 1 Nm<br>(note max. torque of mating connector!)   |
| Mechanical life                 | > 100 Mating cycles                                       |
| Pollution degree                | 3   |
| Protection class (When coupled) | IP68, IP69K<br>NEMA: 1, 3, 4, 6P                          |
| Connector B                     | Male, M8 × 1, Straight                                    |
| Design specification            | Acc. to IEC 61076-2-104                                   |
| Number of contacts              | 4   |
| Contacts                        | Brass, CuZn, Gold-plated                                  |
| Contact carriers                | Plastic, Nylon or TPU, Black                              |
| Connector body                  | Plastic, TPU, Yellow                                      |
| Coupling nut                    | Brass, CuZn, Nickel-plated                                |
| Tightening torque               | 0.4 ... 0.8 Nm<br>(note max. torque of mating connector!) |

### Features



- M12, Female, Straight, 4-pin
- M8, Male, Straight, 4-pin
- Threaded Connector
- General Purpose Cable
- Yellow PVC jacket, 4X26 AWG
- -40 Cold Bend Rating
- Flame Ratings: UL1061, CSA FT1
- Flexlife® and C-Track Approved

### Cable cross section

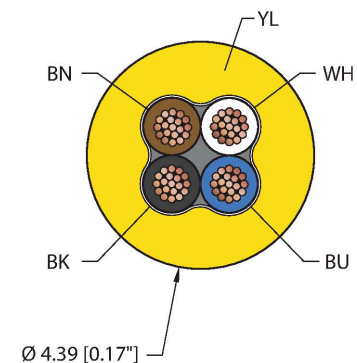

### Contact assignment

RK 4.4T-x-PSG 4M | 21-02-2025 22-44 | Technische Änderungen vorbehalten

## Technische Daten

|                                 |                     |
|---------------------------------|---------------------|
| Mechanical life                 | > 100 Mating cycles |
| Pollution degree                | 3                   |
| Protection class (When coupled) | IP68                |
|                                 | NEMA: 1, 3, 4, 6P   |

| Cable data                    |   |
|-------------------------------|---|
| Cable ID                      | RF50697                                       |
| Total number of conductors    | 4   |
| Cable diameter                | Ø 4.39 mm                                     |
| Cable jacket                  | PVC, Yellow                                   |
| Conductor diameter            | 0.039 "                                       |
| Conductor material            | TC (tinned copper)                            |
| Conductor insulation material | PVC   |
| Conductor size                | 4 x 26 AWG [Similar to 0.14 mm <sup>2</sup> ] |
| Number of strands x O.D.      | 19 x 38 AWG                                   |
| Conductor colors              | BN, WH, BU, BK                                |

| Electrical properties at +20 °C |            |
|---------------------------------|------------|
| Rated voltage                   | 125 VAC/DC |
| Current                         | 2 A        |

| Mechanical and chemical properties  |  |
|-------------------------------------|--|
| Bending radius (static)             | ≥ 5 x Ø                                      |
| Bending radius (dynamic)            | ≥ 10 x Ø                                     |
| Torsion rating                      | Max. 20 million                              |
| UL cold bend rating                 | -40 °C                                       |
| Flex rating 10 x Ø                  | 20 million cycles                            |
|                                     | *When correctly installed at 20 °C, 50 % RH. |
| C-Track                             | Yes  |
| Ambient temperature range (static)  | -40...+105 °C                                |
| Ambient temperature range (dynamic) | 5...+105 °C                                  |
| Temperature range (installation)    | -10...+105 °C                                |

| Approval  |                               |
|-----------|-------------------------------|
| Approvals | UL 2238<br>CE<br>UKCA<br>RoHS |

| Note |  |
|------|--|
|      | - Flex ratings may be reduced if used in extreme temperatures, exposure to certain chemicals, operating above the rated cycle speed, or operating below the rated cable bend radius. |

Connector A

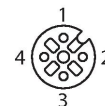

Connector B



## Circuit Diagram



## Technische Daten

- We reserve the right to make technical alterations without prior notice.

## Montagezubehör

### TORQUE-WRENCH-SET-M12-LEGACY

**A900153**

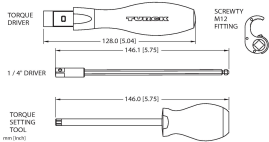

Adjustable torque driver to connect to a Ø15mm knurl. Compatible with the redesigned and legacy M12 cordsets. Includes (1) adjustable torque driver, (1) adjustment tool, (1) 1/4"square to 4mm hex adaptor bit, and (1) Ø15mm spring loaded clamp bit

### BS 8141-0

**U6550**

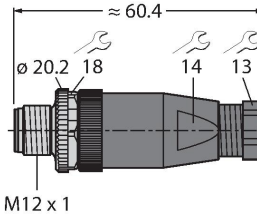

Field-wireable male connector, M12 x 1, straight, 4-pin, screw terminal connection, cable feedthrough 4.0 to 6.0 mm, core cross-section/terminal capacity 0.14 to 0.75 mm<sup>2</sup>, plastic housing, metal retaining screw

## Montagezubehör

### M12-CORDSETS-MOUNTING-CLIP-(10/BAG)

**100016882**

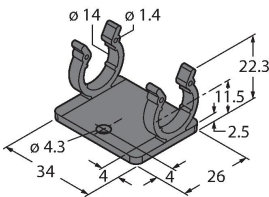

10 Pack of black mounting clips and M4x8mm mounting screws, used to secure cable to cable connection points.