

# EKRT-ESWT-A4.400-WA2Y-x

## Welding Cordset – Extension Cable

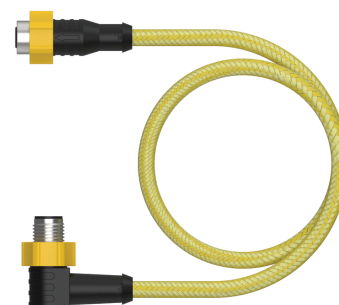
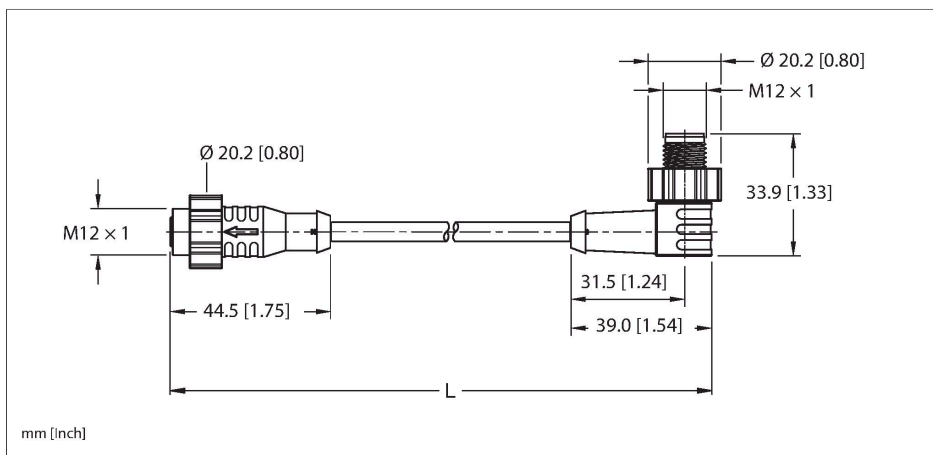

### Technische Daten

Type	EKRT-ESWT-A4.400-WA2Y-x
ID	777046748
Replaces	RK 4.4T-x-WS 4.4T/S3415
Connector A	Female, M12 × 1, Straight, A-code
Design specification	Acc. to IEC 61076-2-101
Number of contacts	4
Contacts	Bronze, CuSn, Gold-plated
Contact carriers	Plastic, Nylon or TPU, Black
Connector body	Plastic, TPU, Black
Coupling nut	Brass, CuZn, Nickel-plated
Connector seal	O-ring, Plastic, FKM/FPM
Torque sleeve	Plastic, PA, Yellow
Tightening torque (range)	0.4 ... 1.8 Nm (note max. torque of mating connector!)
Mechanical life	> 100 Mating cycles
Pollution degree	3
Protection class (When coupled)	IP67
Connector B	Male, M12 × 1, Right angle, A-code
Design specification	Acc. to IEC 61076-2-101
Number of contacts	4
Contacts	Bronze, CuSn, Gold-plated
Contact carriers	Plastic, Nylon or TPU, Black
Connector body	Plastic, TPU, Black
Coupling nut	Brass, CuZn, Nickel-plated
Torque sleeve	Plastic, PA, Yellow

### Features



- M12, Female, Straight, 4-pin, Torque sleeve
- M12, Male, Right-angle, 4-pin, Torque sleeve
- Welding Cable
- Yellow Aramid braid over cable jacket
- Black TPE jacket, 4X22 AWG
- Flame Ratings: UL1061, CSA FT1

### Cable cross section

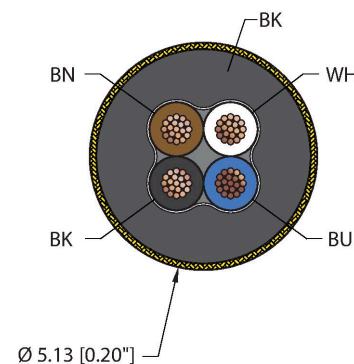

### Contact assignment

## Technische Daten

Tightening torque	0.4 ... 1.8 Nm (note max. torque of mating connector!)
Mechanical life	> 100 Mating cycles
Pollution degree	3
Protection class (When coupled)	IP67

Cable data	
Cable ID	RF52454
Total number of conductors	4
Cable diameter	Ø 5.13 mm
Cable jacket	TPE, Black
Cable jacket covering	Aramid braid, Yellow, 100 % coverage
Conductor diameter	0.048 "
Conductor material	TC (tinned copper)
Conductor insulation material	PVC
Conductor size	4 x 22 AWG [Similar to 0.34 mm <sup>2</sup> ]
Number of strands x O.D.	19 x 0.0058 "
Conductor colors	BN, WH, BU, BK

Electrical properties at +20 °C	
Rated voltage	250 V <sub>AC</sub> /300 V <sub>DC</sub>
Current	4 A

Mechanical and chemical properties	
Bending radius (static)	≥ 5 x Ø
Bending radius (dynamic)	≥ 10 x Ø
Ambient temperature range (static)	-40...+105 °C
Ambient temperature range (dynamic)	5...+105 °C
Temperature range (installation)	-10...+105 °C

Approval	
Approvals	UL 2238 CSA C22.2 No. 182.3 CE UKCA RoHS

Note	
	- Flex ratings may be reduced if used in extreme temperatures, exposure to certain chemicals, operating above the rated cycle speed, or operating below the rated cable bend radius.
	- The torque sleeve can be removed, before or after installation by inserting a small flat screwdriver near the relief by the arrow and prying.

Connector A

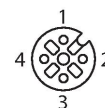

Connector B

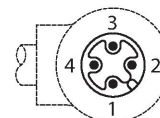

## Circuit Diagram

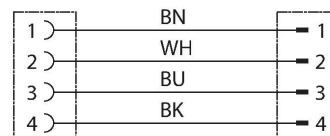

## Technische Daten

- We reserve the right to make technical alterations without prior notice.

## Montagezubehör

### M12-TORQUE-SLEEVE,YELLOW(10PACK)

**A900167**



10 Pack of Yellow Torque Sleeves for the new M12 cordsets. Compatible with male, female, straight and right-angled, stainless steel and nickel-plated brass coupling nuts.

### TORQUE-WRENCH-SET-M12/SW13

**A900152**

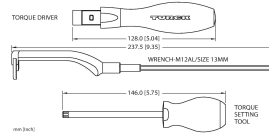

Adjustable torque driver to connect to the 13mm hex. Compatible with redesigned M12 cordsets, M12 Power, and M12 X-code. NOT Compatible with legacy M12 cordsets. Includes (1) adjustable torque driver, (1) adjustment tool, and (1) 13mm forked bit.

## Montagezubehör

### M12-CORDSETS-MOUNTING-CLIP-(10/BAG)

**100016882**

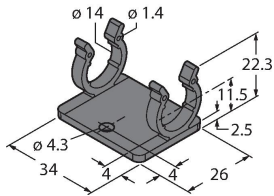

10 Pack of black mounting clips and M4x8mm mounting screws, used to secure cable to cable connection points.