

Accessories

Thermowell

For Temperature Sensors

THW-6-G1/2-A4-L250

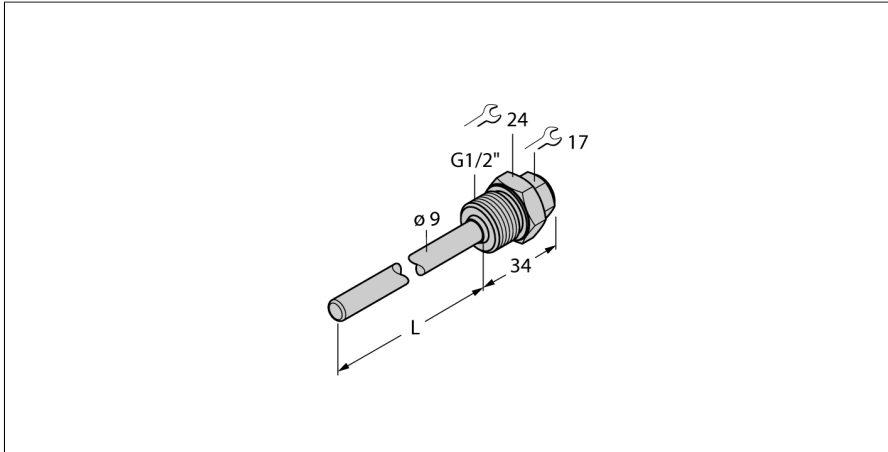

Type	THW-6-G1/2-A4-L250
ID	9910462
Temperature range	
Measuring range	-50...350 °C
Measuring range	-58...662 °F
Immersion depth (L)	250 mm
Outer diameter	9 mm
Mechanical data	
Housing material	Stainless steel
Internal diameter	6.2 mm
Process connection	G 1/2" male thread
Process Pressure	400 bar
Max. tightening torque of housing nut	100 Nm

- Thermowell for mounting temperature probes
- End tip diameter 6 mm
- Process connection G1/2" male thread
- Immersion depth 250 mm

General description

Thermowells protect the probes against aggressive substances and high pressures. The probes do not come into contact with any media. They can be replaced without interrupting the process.