

# Accessories

## Thermowell

### For Temperature Sensors

#### THW-6-N1/2-A4-L050

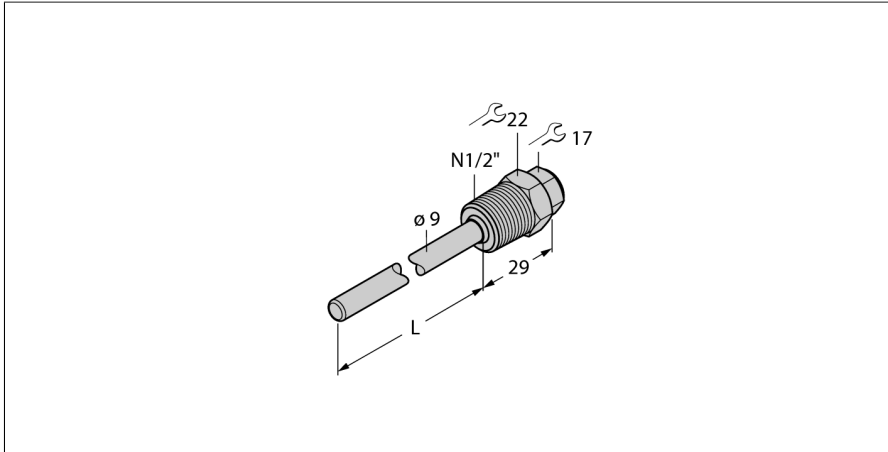

- Thermowell for mounting temperature probes
- End tip diameter 6 mm
- Process connection 1/2" NPT male thread
- Immersion depth 50 mm

**General description**

Thermowells protect the probes against aggressive substances and high pressures. The probes do not come into contact with any media. They can be replaced without interrupting the process.

Type	THW-6-N1/2-A4-L050
ID	9910463

<b>Temperature range</b>	
Measuring range	-50...350 °C
Measuring range	-58...662 °F
Immersion depth (L)	50 mm
Outer diameter	9 mm

<b>Mechanical data</b>	
Housing material	Stainless steel
Internal diameter	6.2 mm
Process connection	1/2" NPT male thread
Process Pressure	400 bar
Max. tightening torque of housing nut	100 Nm