

TP-203A-CF-H1141-L200

Temperature Detection – Probe

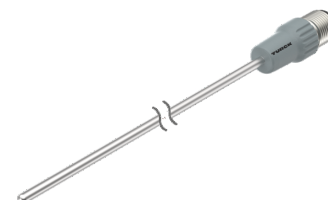
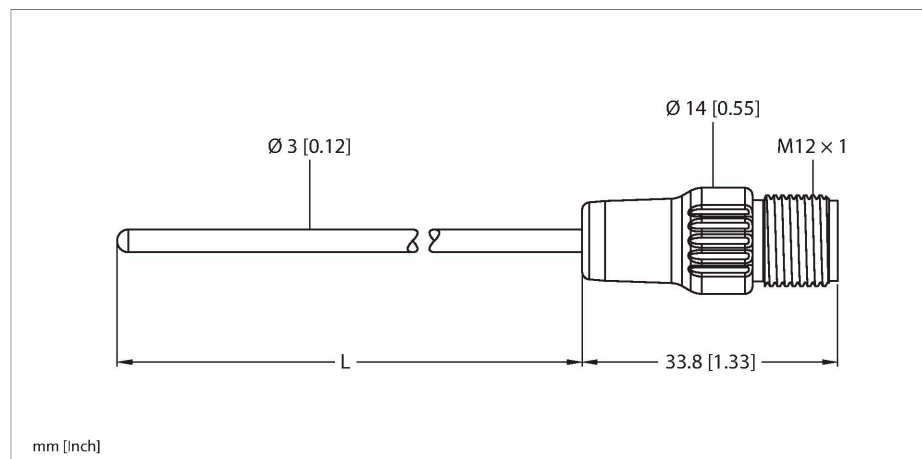

Technical data

Type	TP-203A-CF-H1141-L200
ID	9910482
Temperature range	
Measuring range	-50...500 °C
Measuring range	-58...932 °F
Accuracy	±0.15 K + 0.002 • t (-30...300 °C)
Measuring element	Pt-100 probe, DIN EN 60751, class A, connection mode: 4-wire connection
Self-heating	0.4 K/mW at 0 °C
Response time	t 0.5 = 1.5 s / t 0.9 = 6.0 s in water at 0.2 m/s
Immersion depth (L)	200 mm
Process Pressure	100 bar
Mechanical data	
Housing material	Stainless steel, 1.4404 (AISI 316L)
Process connection	For compression fittings, thermowell or direct mounting
Electrical connection	Connector, M12 × 1
Protection class	IP67
Environmental conditions	
Ambient temperature	-40...+120 °C
Storage temperature	-40...+85 °C
Tests/approvals	
UL registration number	E345414

Features

- Pt 100 probe according to DIN EN 60751
- Resistant to vibrations and shocks
- Connectable to TS, TTM, IM34, BL20, BL67
- Max. temperature connector: 120°C
- Connection mode: 4-wire connection

Wiring diagram

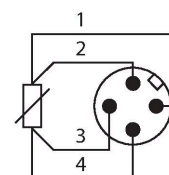

Functional principle

Resistance thermometers are used for the detection and monitoring of temperatures to optimize and control a process. Typical applications are in machine and plant construction as well as in the process industry. The core element of the temperature probe is a temperature-dependent resistor.

Technical data

Reference conditions acc. to IEC 61298-1	
Temperature	15...+25 °C
Atmospheric pressure	860...1060 hPa abs.
Humidity	45...75 % rel.
Auxiliary power	24 VDC
MTTF	2283 years acc. to SN 29500 (Ed. 99) 20 °C

Technical data

Type	TP-203A-CF-H1141-L200
ID	9910482
Temperature range	
Measuring range	-50...500 °C
Measuring range	-58...932 °F
Accuracy	±0.15 K + 0.002 • t (-30...300 °C)
Self-heating	0.4 K/mW at 0 °C
Measuring element	Pt-100 probe, DIN EN 60751, class A, connection mode: 4-wire connection
Response time	t 0.5 = 1.5 s / t 0.9 = 6.0 s in water at 0.2 m/s
Immersion depth (L)	200 mm
Outer diameter	3 mm
Protection type and class	IP67
Environmental conditions	
Ambient temperature	-40...+120 °C
Storage temperature	-40...+85 °C
Mechanical data	
Housing material	Stainless steel, 1.4404 (AISI 316L)
Sensor material	Stainless steel, 1.4404 (AISI 316L)
Process connection	For compression fittings, thermowell or direct mounting
Process Pressure	100 bar
Electrical connection	Connector, M12 × 1
Reference conditions acc. to IEC 61298-1	
Temperature	15...+25 °C
Atmospheric pressure	860...1060 hPa abs.
Humidity	45...75 % rel.
Auxiliary power	24 VDC

Technical data

Tests/approvals

Approvals	cULus
UL registration number	E345414
MTTF	2283 years acc. to SN 29500 (Ed. 99) 20 °C