

# Accessories

## Compression Fitting

### For Temperature Sensors

#### CF-M-6-G1/2-A4

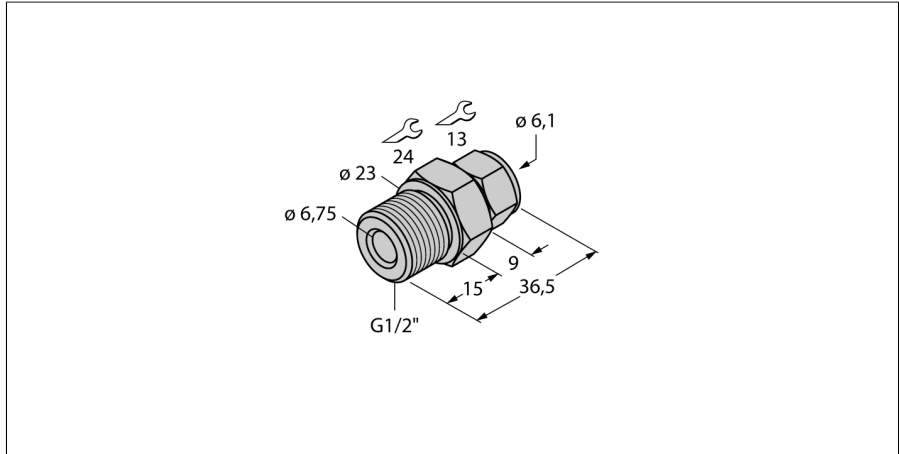

- Compression fittings for direct mounting of TP temperature probes
- Metal compression fitting
- For probe with 6 mm diameter
- Process connection G1/2" male thread

**General description**

With compression fittings, probes can be mounted directly where they are needed and they can be immersed as deep as wanted. Through direct contact with the medium, they react immediately to temperature changes.

Type	CF-M-6-G1/2-A4
ID	9910530
<b>Temperature range</b>	
Measuring range	-50...350 °C
Measuring range	-58...662 °F
<b>Mechanical data</b>	
Housing material	Stainless steel, 1.4404 (AISI 316L)
Sealing material	stainless steel
Internal diameter	7 mm
Process connection	G 1/2" male thread
Process Pressure	100 bar
Max. tightening torque of housing nut	100 Nm