

# RK 12T-10-RS 12T

## Actuator and Sensor Cordset – Extension Cable

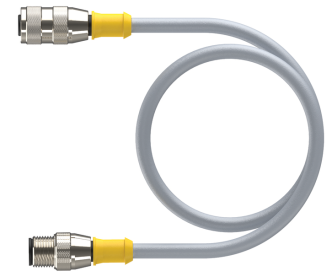
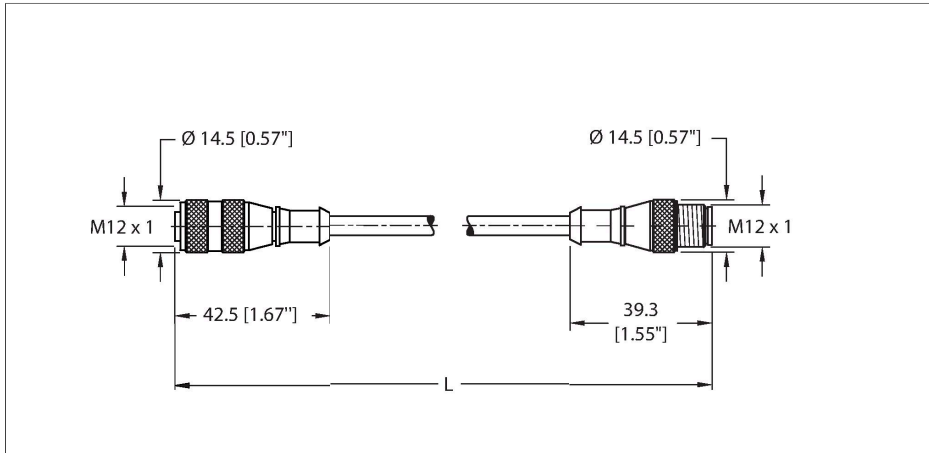

### Technical data

Type	RK 12T-10-RS 12T
ID	U-06655
Connector A	Female, M12 × 1, Straight, A-code
Design specification	Acc. to IEC 61076-2-101
Number of contacts	12
Contacts	Bronze, CuSn, Gold-plated
Contact carriers	Plastic, TPU, Black
Connector body	Plastic, TPU, Yellow
Coupling nut	Brass, CuZn, Nickel-plated
Connector seal	O-ring, Plastic, FKM/FPM
Tightening torque (range)	0.8 ... 1 Nm (note max. torque of mating connector!)
Mechanical life	> 100 Mating cycles
Pollution degree	3
Protection class (When coupled)	IP68, IP69K NEMA: 1, 3, 4, 6P
Connector B	Male, M12 × 1, Straight, A-code
Design specification	Acc. to IEC 61076-2-101
Number of contacts	12
Contacts	Bronze, CuZn, Gold-plated
Contact carriers	Plastic, Nylon or TPU, Black
Connector body	Plastic, TPU, Yellow
Coupling nut	Brass, CuZn, Nickel-plated
Tightening torque	0.8 ... 1 Nm (note max. torque of mating connector!)

### Features



- M12, Female, Straight, 12-pin
- M12, Male, Straight, 12-pin
- IP68, IP69K
- General Purpose Cable
- Gray PVC jacket, 12X24 AWG
- -40 Cold Bend Rating
- Flame Ratings: UL1061, CSA FT1

### Cable cross section

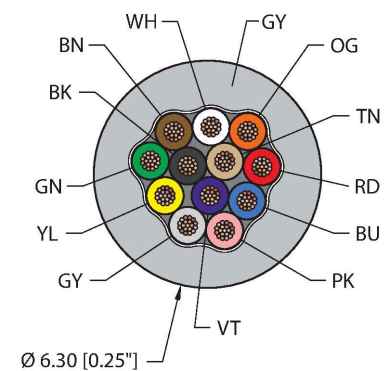

### Contact assignment

## Technical data

Mechanical life	> 100 Mating cycles
Pollution degree	3
Protection class (When coupled)	IP68, IP69K
	NEMA: 1, 3, 4, 6P

### Cable data

Cable ID	RF50991
Total number of conductors	12
Cable diameter	Ø 6.3 mm
Length (L)	10 m, (+50mm or 4% of length/-0.0, Whichever is greater)
Cable jacket	PVC, Gray
Conductor diameter	0.043 "
Conductor material	TC (tinned copper)
Conductor insulation material	PVC
Conductor size	12 x 24 AWG [Similar to 0.25 mm <sup>2</sup> ]
Number of strands x O.D.	19 x 36 AWG
Conductor colors	WH, BN, GN, YE, GY, PK, BU, RD, OR, TN, BK, VT

### Electrical properties at +20 °C

Rated voltage	30 V
Current	2 A

### Mechanical and chemical properties

Bending radius (static)	≥ 5 x Ø
Bending radius (dynamic)	≥ 10 x Ø
UL cold bend rating	-40 °C
Flex rating 20 x Ø	10 million cycles*

\*When properly installed @ 20°C, 50%RH, and a cycle speed of ≤0.5 cycles per second.

Ambient temperature range (static)	-40 °C...+105 °C
Ambient temperature range (dynamic)	5 °C...+105 °C
Temperature range (installation)	-10 °C...+105 °C

### Approval

Approvals	UL 2238 CSA C22.2 No. 182.3 CE UKCA RoHS
-----------	--

### Note

- Flex ratings may be reduced if used in extreme temperatures, exposure to certain chemicals, operating above the

Connector A

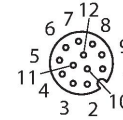

Connector B

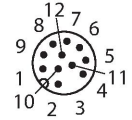

## Circuit Diagram

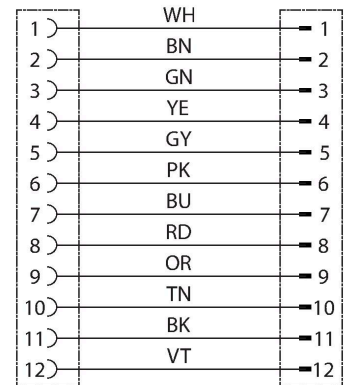

## Technical data

rated cycle speed, or operating below the rated cable bend radius.

- We reserve the right to make technical alterations without prior notice.

## Accessories

**TORQUE-WRENCH-SET-M12-LEGACY                      A900153**

Adjustable torque driver to connect to a Ø15mm knurl. Compatible with the redesigned and legacy M12 cordsets. Includes (1) adjustable torque driver, (1) adjustment tool, (1) 1/4" square to 4mm hex adaptor bit, and (1) Ø15mm spring loaded clamp bit

## Accessories

**M12-CORDSETS-MOUNTING-CLIP-(10/BAG)                      100016882**

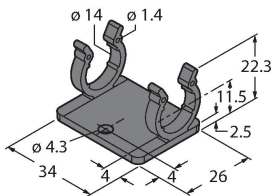

10 Pack of black mounting clips and M4x8mm mounting screws, used to secure cable to cable connection points.