

# RSM RKM 106-7M/S3059

## Actuator and Sensor Cable – Extension Cable

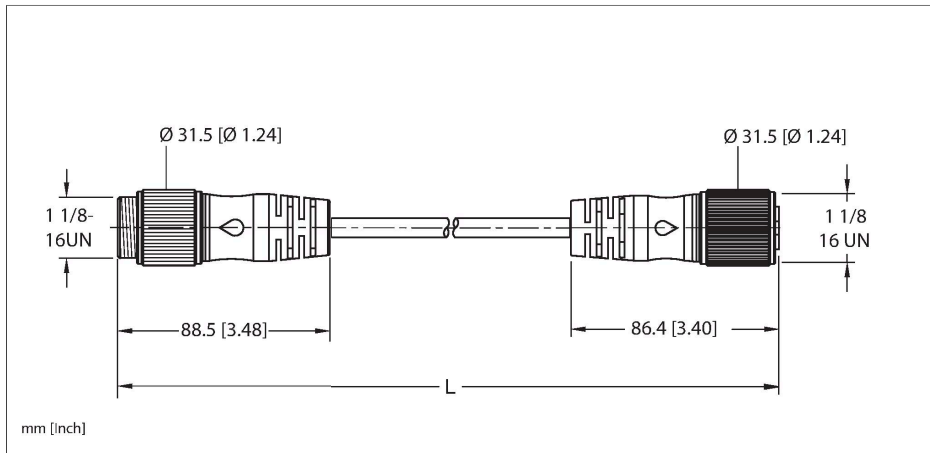

### Features



- 1-1/8" Male, Straight, 10-pin
- 1-1/8" Female, Straight, 10-pin
- Power Tray/Exposed Run/Direct Burial Cable
- Yellow TPE jacket, 10X16 AWG
- Sunlight Resistant
- -40 Cold Bend Rating
- Oil Resistant
- Flame Ratings: UL 1685 FT4, UL 1061, CSA FT1, CSA FT4

### Cable cross section

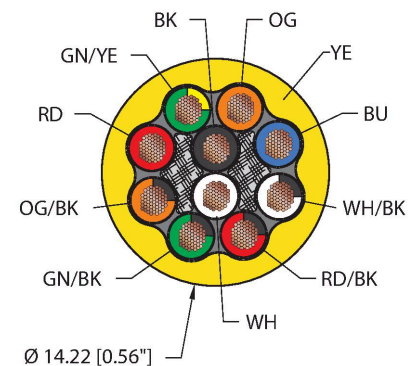

### Contact assignment

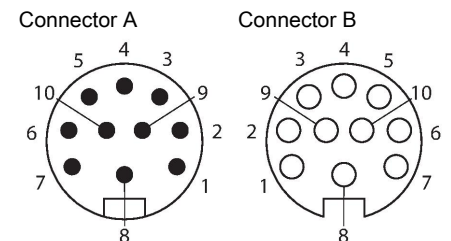

### Technische Daten

Type	RSM RKM 106-7M/S3059
ID	U-38571
Connector A	Male, 1 1/8"-16 UN, Straight
Number of contacts	10
Contacts	Brass, CuZn, Gold-plated
Contact carriers	Plastic, TPU, Yellow
Connector body	Plastic, TPU, Yellow
Coupling nut	Brass, CuZn, Nickel-plated
Tightening torque	3 Nm
Mechanical life	> 100 Mating cycles
Pollution degree	3
Protection class (When coupled)	IP67, IP68, IP69, IP69K
	NEMA: 1, 3, 4, 6P, 12
Connector B	Female, 1 1/8"-16 UN, Straight
Number of contacts	10
Contacts	Brass, CuZn, Gold-plated
Contact carriers	Plastic, TPU, Yellow
Connector body	Plastic, TPU, Yellow
Coupling nut	Brass, CuZn, Nickel-plated
Protection class (When coupled)	IP67, IP68, IP69, IP69K
	NEMA: 1, 3, 4, 6P, 12
Cable data	
Cable ID	RF51751
Total number of conductors	10

## Technische Daten

Cable diameter	Ø 14.22 mm
Length (L)	7 m, (+50mm or 4% of length/-0.0, Whichever is greater)
Cable jacket	TPE, Yellow
Conductor diameter	0.105 "
Conductor material	BC (bare copper)
Conductor insulation material	PVC/Nylon (Nylon overcoat)
Conductor size	10 x 16 AWG [Similar to 1.50 mm <sup>2</sup> ]
Number of strands x O.D.	65 x 34 AWG
Conductor colors	OG, BU, WH/BK, RD/BK, GN/BK, OG/BK, RD, GN/YE, BK, WH

### Electrical properties at +20 °C

Rated voltage	600 V
Current	7 A

### Mechanical and chemical properties

Bending radius (static)	≥ 5 x Ø
Bending radius (dynamic)	≥ 10 x Ø
UL cold bend rating	-40 °C
Ambient temperature range (static)	-40...+90 °C
Ambient temperature range (dynamic)	5...+90 °C
Temperature range (installation)	-10...+90 °C

### Approval

Approvals	UL 2238 CE RoHS
-----------	-----------------------

### Note

- Flex ratings may be reduced if used in extreme temperatures, exposure to certain chemicals, operating above the rated cycle speed, or operating below the rated cable bend radius.

- We reserve the right to make technical alterations without prior notice.

## Circuit Diagram

