

# PKG 3M-3.4-RS 4T

## Actuator and Sensor Cable – Extension Cable

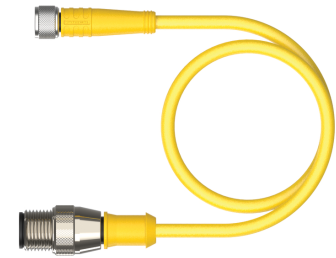
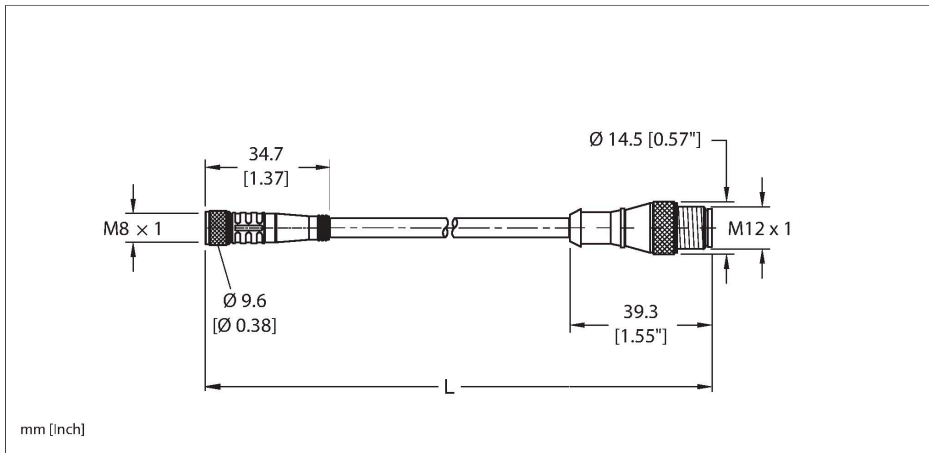

### Technische Daten

Type	PKG 3M-3.4-RS 4T
ID	U-84403
Connector A	Female, M8 × 1, Straight
Design specification	Acc. to IEC 61076-2-104
Number of contacts	3
Contacts	Brass, CuZn, Gold-plated
Contact carriers	Plastic, Nylon or TPU, Black
Connector body	Plastic, TPU, Yellow
Coupling nut	Brass, CuZn, Nickel-plated
Connector seal	O-ring, Plastic, FKM/FPM
Tightening torque (range)	0.4 ... 0.8 Nm (note max. torque of mating connector!)
Mechanical life	> 100 Mating cycles
Pollution degree	3
Protection class (When coupled)	IP67
	NEMA: 1, 3, 4, 6P
Connector B	Male, M12 × 1, Straight, A-code
Design specification	Acc. to IEC 61076-2-101
Number of contacts	4
Contacts	Brass, CuZn, Gold-plated
Contact carriers	Plastic, TPU, Black
Connector body	Plastic, TPU, Yellow
Coupling nut	Brass, CuZn, Nickel-plated
Tightening torque	0.8 ... 1 Nm (note max. torque of mating connector!)

### Features



- M8, Female, Straight, 3-pin
- Threaded connector
- M12, Male, Straight, 3-pin
- General Purpose Cable
- Yellow PVC jacket, 3X24 AWG
- -40 Cold Bend Rating
- Flame Ratings: UL1061, CSA FT1
- Flexlife® and C-Track Approved

### Cable cross section

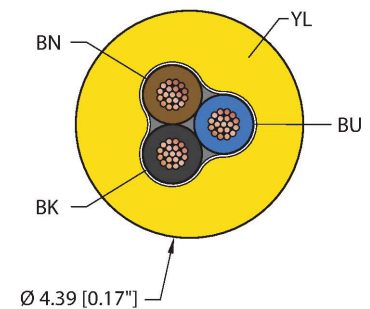

### Contact assignment

## Technische Daten

Mechanical life	> 100 Mating cycles
Pollution degree	3
Protection class (When coupled)	IP68, IP69K
	NEMA: 1, 3, 4, 6P

Cable data	
Cable ID	RF50642
Total number of conductors	3
Cable diameter	Ø 4.39 mm
Length (L)	3.4 m
Cable jacket	PVC, Yellow
Conductor diameter	0.044 "
Conductor material	TC (tinned copper)
Conductor insulation material	PVC
Conductor size	3 x 24 AWG [Similar to 0.25 mm <sup>2</sup> ]
Number of strands x O.D.	19 x 36 AWG
Conductor colors	BN, BU, BK

Electrical properties at +20 °C	
Rated voltage	250 VAC/DC
Current	4 A

Mechanical and chemical properties	
Bending radius (static)	≥ 5 x Ø
Bending radius (dynamic)	≥ 10 x Ø
UL cold bend rating	-40 °C
Flex rating 20 x Ø	10 million cycles

\*When properly installed @ 20°C, 50%RH, and a cycle speed of ≤0.5 cycles per second.

C-Track	Yes
Ambient temperature range (static)	-40...+105 °C
Ambient temperature range (dynamic)	5...+105 °C
Temperature range (installation)	-10...+105 °C

Approval	
Approvals	UL 2238 CE UKCA RoHS

**Note**

- Flex ratings may be reduced if used in extreme temperatures, exposure to certain chemicals, operating above the rated

Connector A



Connector B

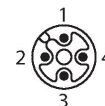

## Circuit Diagram

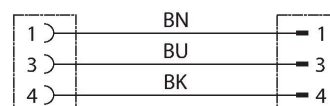

## Technische Daten

cycle speed, or operating below the rated cable bend radius.

- We reserve the right to make technical alterations without prior notice.

## Montagezubehör

### TORQUE-WRENCH-SET-M12-LEGACY A900153

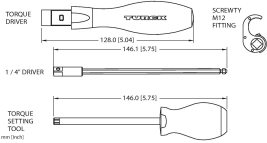

Adjustable torque driver to connect to a Ø15mm knurl. Compatible with the redesigned and legacy M12 cordsets. Includes (1) adjustable torque driver, (1) adjustment tool, (1) 1/4"square to 4mm hex adaptor bit, and (1) Ø15mm spring loaded clamp bit

## Montagezubehör

### M8-CORDSETS-MOUNTING-CLIP-(10/BAG) 200005995

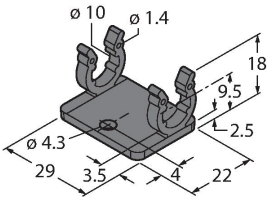

10 Pack of black mounting clips and M4x8mm mounting screws, used to secure cable to cable connection points.