

RSCD RJ45 440-4M/C1246

Industrial Ethernet Cable – Extension Cable

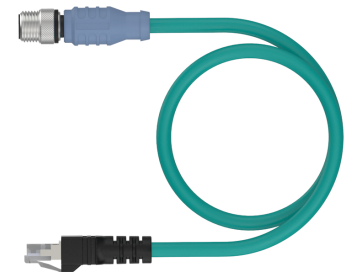
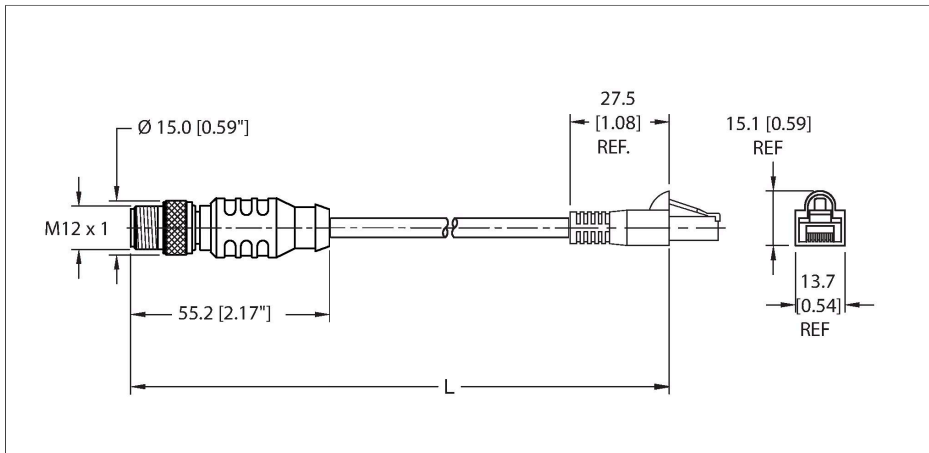

Technische Daten

Type	RSCD RJ45 440-4M/C1246
ID	U2-22623
Connector A	Male, M12 × 1, Straight, D-code
Number of contacts	4
Contacts	Bronze, CuSn, Gold-plated
Contact carriers	Plastic, TPU, Black
Connector body	Plastic, TPU, Black
Coupling nut	Brass, CuZn, Nickel-plated
Tightening torque (range)	0.8 ... 1 Nm (note max. torque of mating connector!)
Mechanical life	> 100 Mating cycles
Pollution degree	3
Protection class (When coupled)	IP67, IP68, IP69, IP69K NEMA: 1, 3, 4, 6P, 12
Connector B	Male, RJ45, Straight
Number of contacts	8
Contacts	Bronze, CuSn, Gold-plated
Contact carriers	Plastic, PC, Transparent
Connector body	Plastic, TPU, Black
Pollution degree	2
Protection class (When coupled)	IP20 NEMA: 1
Cable data	
Cable ID	RF51210

Features



- M12, Male, Straight, 4-pin
- D-code (reverse key)
- RJ45, Male, Straight, 8-pin
- Unshielded Twisted Pair
- Industrial Ethernet Cable
- fieldbus type: Ethernet CAT5E, TPE jacket, Teal, 2UTPX24 AWG
- -40 Cold Bend Rating
- Flame Ratings: UL 1685, UL1061
- Flexlife® and C-Track Approved

Cable cross section

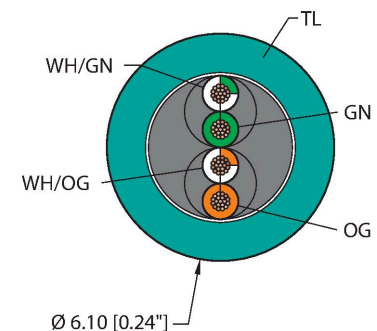

Contact assignment

RSCD RJ45 440-4M/C1246 | 21-02-2025 23-14 | Technische Änderungen vorbehalten

Technische Daten

Fieldbus	Ethernet, 440
Total number of conductors	4
Cable diameter	Ø 6.1 mm
Length (L)	4 m
Cable jacket	TPE, Teal
Conductor material	TC (tinned copper)
Conductor colors	WH/GN, GN, WH/OG, OG
Description of assembly	UTP (Unshielded Twisted Pair)
Number of pairs	2
Conductor diameter	0.042 "
Conductor insulation material	HDPE
Cable conductor cross-section	2x24 AWG [Similar to 0.25 mm ²]
Number of strands x O.D.	7x32 AWG
Electrical properties at +20 °C	
Rated voltage	42 V(UL 1863)
Current	1.5 A
Mechanical and chemical properties	
Bending radius (static)	≥ 4 x Ø
Bending radius (dynamic)	≥ 10 x Ø
Bending radius (C-track)	≥ 4 In.
Bending cycles (C-track)	35 Million *
Torsional stress	± 270 °/m
Torsion rating	Max. 3 million
Torsional stress	52 Cycles/min
UL cold bend rating	-40 °C
	*When properly installed @ 20°C, 50%RH, and a cycle speed of ≤0.5 cycles per second.
C-Track	Yes
Ambient temperature range (static)	-40...+80 °C
Ambient temperature range (dynamic)	5...+80 °C
Temperature range (installation)	-10...+80 °C
Approval	
Approvals	CE UKCA RoHS
Note	

- Flex ratings may be reduced if used in extreme temperatures, exposure to certain chemicals, operating above the rated

Connector A

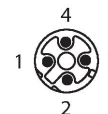

Connector B

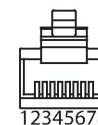

Circuit Diagram

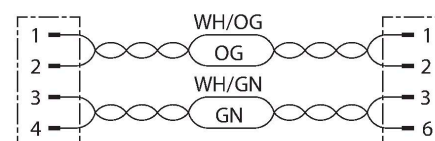

Technische Daten

cycle speed, or operating below the rated cable bend radius.

- We reserve the right to make technical alterations without prior notice.

Montagezubehör

M12-CORDSETS-MOUNTING-CLIP-(10/BAG)

100016882

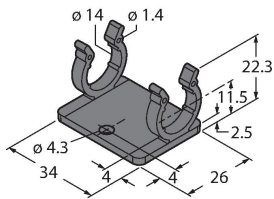

10 Pack of black mounting clips and M4x8mm mounting screws, used to secure cable to cable connection points.