

# RK 4.22T-34

## Actuator and Sensor Cable – Connection Cable

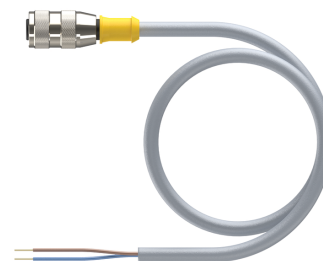
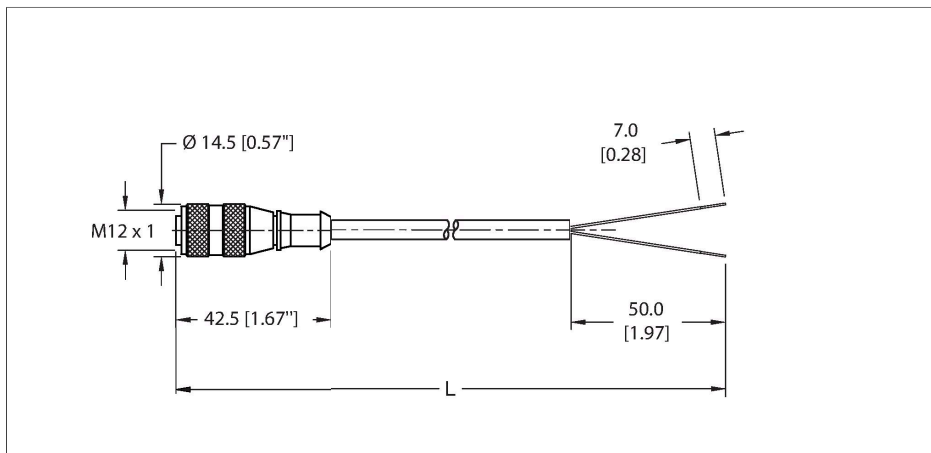

### Technische Daten

|                                 |  |
|---------------------------------|--|
| Type                            | RK 4.22T-34  |
| ID                              | UX00049  |
| Connector A                     | Female, M12 × 1, Straight, A-code                        |
| Design specification            | Acc. to IEC 61076-2-101                                  |
| Number of contacts              | 4  |
| Contacts                        | Brass, CuZn, Gold-plated                                 |
| Contact carriers                | Plastic, Nylon or TPU, Black                             |
| Connector body                  | Plastic, TPU, Yellow                                     |
| Coupling nut                    | Brass, CuZn, Nickel-plated                               |
| Connector seal                  | O-ring, Plastic, FKM/FPM                                 |
| Tightening torque (range)       | 0.8 ... 1 Nm<br>(note max. torque of mating connector!)  |
| Mechanical life                 | > 100 Mating cycles                                      |
| Pollution degree                | 3  |
| Protection class (When coupled) | IP68, IP69K<br>NEMA: 1, 3, 4, 6P                         |
| <b>Cable data</b>               |  |
| Cable ID                        | RF50529  |
| Total number of conductors      | 2  |
| Cable diameter                  | Ø 5.13 mm  |
| Length (L)                      | 34 m, (+50mm or 4% of length/-0.0, Whichever is greater) |
| Cable jacket                    | PVC, Gray  |
| Conductor diameter              | 0.061 "  |
| Conductor material              | TC (tinned copper)                                       |

### Features



- M12, Female, Straight, 2-pin
- Instrumentation Tray Cable
- Gray PVC jacket, 2X20 AWG
- Sunlight Resistant
- -40 Cold Bend Rating
- Oil Resistant
- Flame Ratings: UL 1685 FT4, UL1061, CSA FT4
- Flexlife® and C-Track Approved

### Cable cross section

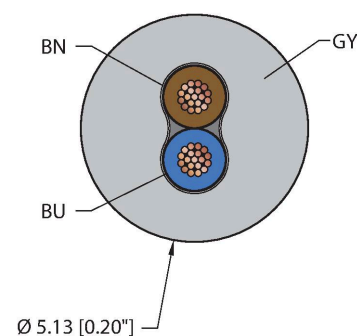

### Contact assignment

## Connector A

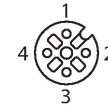

## Circuit Diagram

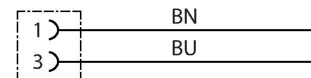

## Technische Daten

|   |  |
|---|--|
| Conductor insulation material             | PVC  |
| Conductor size                            | 2 x 20 AWG [Similar to 0.50 mm <sup>2</sup> ]  |
| Number of strands x O.D.                  | 19 x 0.0073 "  |
| Conductor colors                          | BN, BU   |
| <b>Electrical properties at +20 °C</b>    |  |
| Rated voltage                             | 250 V  |
| Current                                   | 4 A  |
| <b>Mechanical and chemical properties</b> |  |
| Bending radius (static)                   | ≥ 5 x Ø  |
| Bending radius (dynamic)                  | ≥ 10 x Ø   |
| UL cold bend rating                       | -40 °C   |
| Flex rating 20 x Ø                        | 10 million cycles  |
|   | *When properly installed @ 20°C, 50%RH, and a cycle speed of ≤0.5 cycles per second. |
| C-Track                                   | Yes  |
| Ambient temperature range (static)        | -40...+105 °C  |
| Ambient temperature range (dynamic)       | 5...+105 °C  |
| Temperature range (installation)          | -10...+105 °C  |
| <b>Approval</b>                           |  |
| Approvals                                 | UL 2238<br>CSA C22.2 No. 182.3<br>CE<br>UKCA<br>RoHS                                 |

## Note

- Flex ratings may be reduced if used in extreme temperatures, exposure to certain chemicals, operating above the rated cycle speed, or operating below the rated cable bend radius.

- We reserve the right to make technical alterations without prior notice.

## Montagezubehör

### TORQUE-WRENCH-SET-M12-LEGACY

A900153

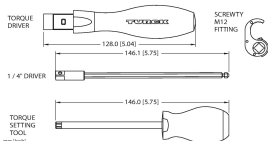

Adjustable torque driver to connect to a Ø15mm knurl. Compatible with the redesigned and legacy M12 cordsets. Includes (1) adjustable torque driver, (1) adjustment tool, (1) 1/4"square to 4mm hex adaptor bit, and (1) Ø15mm spring loaded clamp bit

## Montagezubehör

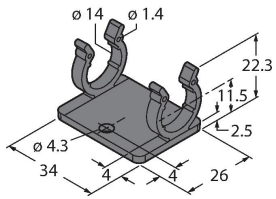
**M12-CORDSETS-MOUNTING-CLIP-(10/BAG)****100016882**

10 Pack of black mounting clips and M4x8mm mounting screws, used to secure cable to cable connection points.