

# RJ45S RJ45S 860-55M

## Industrial Ethernet Cable – Extension Cable

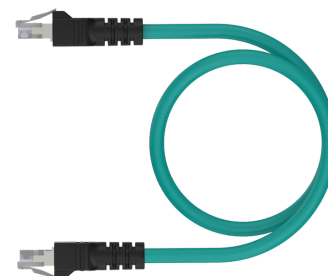
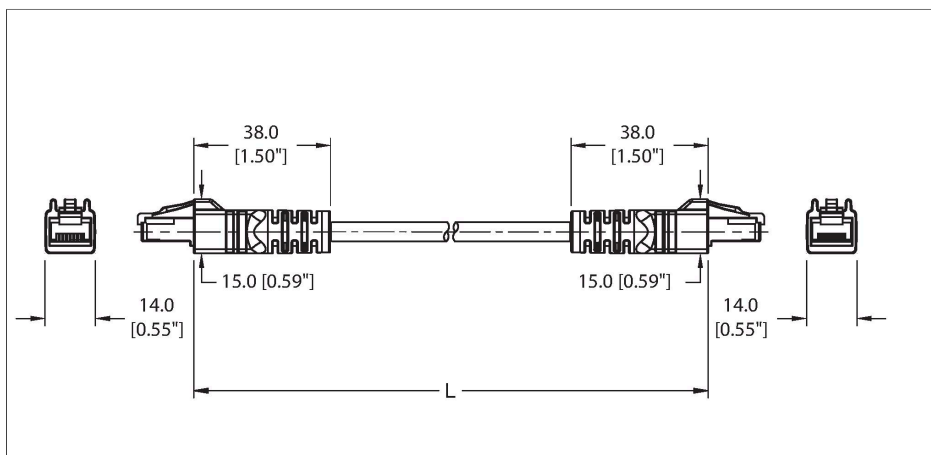

### Technical data

Type	RJ45S RJ45S 860-55M
ID	UX03525
Connector A	Male, RJ45, Straight
Number of contacts	8
Contacts	Bronze, CuSn, Gold-plated
Contact carriers	Plastic, PC, Transparent
Connector body	Plastic, TPU, Black
Protection class (When coupled)	IP20
	NEMA: 1
Connector B	Male, RJ45, Straight
Number of contacts	8
Contacts	Bronze, CuSn, Gold-plated
Contact carriers	Plastic, PC, Transparent
Connector body	Plastic, TPU, Black
Protection class (When coupled)	IP20
	NEMA: 1
Cable data	
Cable ID	RF52026
Fieldbus	Ethernet, 860
Total number of conductors	8
Cable diameter	Ø 7.37 mm
Length (L)	55 m
Cable jacket	TPE, Teal

### Features



- RJ45, Male, Straight, 8-pin, Shielded
- RJ45, Male, Straight, 8-pin, Shielded
- Industrial Ethernet Cable
- Fieldbus type: Ethernet CAT6A, Teal TPE jacket, shielded, 4UTPX26 AWG
- -40 Cold Bend Rating
- Flame Ratings: UL 1666, UL1061
- Flexlife® and C-Track Approved

### Cable cross section

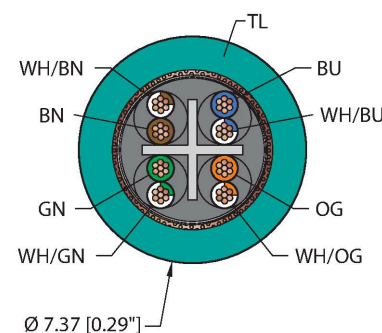

### Contact assignment

## Technical data

Shielding	Aluminum/polyester (OUT), 38 AWG, TC (Tinned Copper), 75% coverage
Conductor material	TC (tinned copper)
Conductor colors	WH/OG, OG, WH/GN, GN, WH/BN, BN, WH/BU, BU
Description of assembly	UTP (Unshielded Twisted Pair)
Number of pairs	4
Conductor diameter	0.034 "
Conductor insulation material	HDPE
Cable conductor cross-section	2x26 AWG [Similar to 0.14 mm <sup>2</sup> ]
Number of strands x O.D.	7x34 AWG
<b>Electrical properties at +20 °C</b>	
Rated voltage	42 V
Current	1.5 A
<b>Mechanical and chemical properties</b>	
Bending radius (static)	≥ 4 x Ø
Bending radius (dynamic)	≥ 10 x Ø
Bending radius (C-track)	≥ 4 In.
Bending cycles (C-track)	35 Million *
Torsional stress	± 270 °/m
Torsion rating	Max. 3 million
Torsional stress	52 Cycles/min
UL cold bend rating	-40 °C
	*When properly installed @ 20°C, 50%RH, and a cycle speed of ≤0.5 cycles per second.
C-Track	Yes
Ambient temperature range (static)	-40...+80 °C
Ambient temperature range (dynamic)	5...+80 °C
Temperature range (installation)	-10...+80 °C
<b>Approval</b>	
Approvals	UL Listed CE UKCA RoHS
<b>Note</b>	
	- Flex ratings may be reduced if used in extreme temperatures, exposure to certain chemicals, operating above the rated cycle speed, or operating below the rated cable bend radius.

Connector A

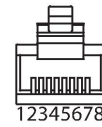

Connector B



## Circuit Diagram

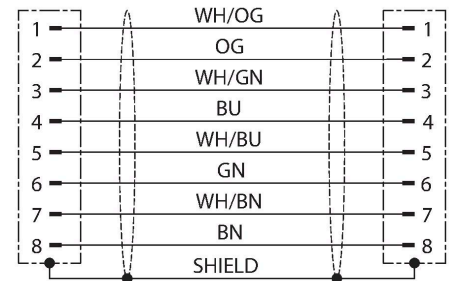

## Technical data

- We reserve the right to make technical alterations without prior notice.

---