

RK 4.4T-2-RS 4.4T/S3415

Actuator and Sensor Cable – Extension Cable

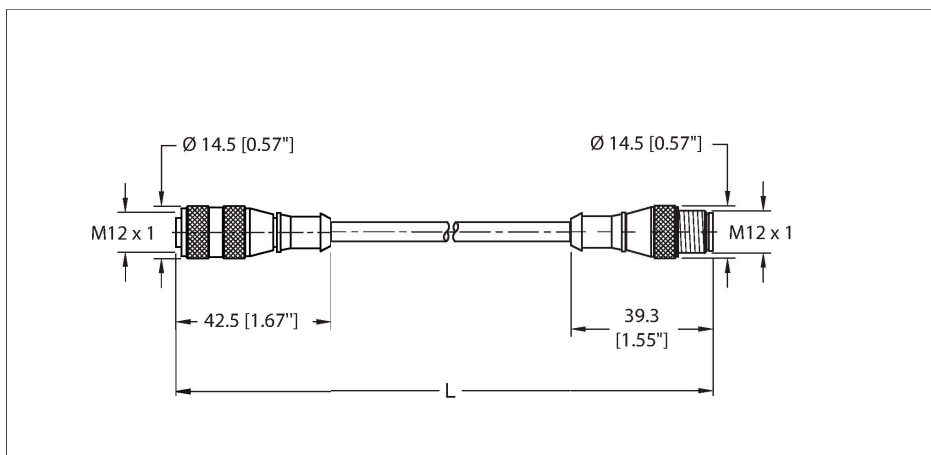

Technische Daten

Type	RK 4.4T-2-RS 4.4T/S3415
ID	UX04162
Special version	S3415 = Black plug body and yellow aramid over-braid cable jacket
Connector A	Female, M12 × 1, Straight, A-code
Design specification	Acc. to IEC 61076-2-101
Number of contacts	4
Contacts	Brass, CuZn, Gold-plated
Contact carriers	Plastic, Nylon or TPU, Black
Connector body	Plastic, TPU, Black
Coupling nut	Brass, CuZn, Nickel-plated
Connector seal	O-ring, Plastic, FKM/FPM
Tightening torque (range)	0.8 ... 1 Nm (note max. torque of mating connector!)
Mechanical life	> 100 Mating cycles
Pollution degree	3
Protection class (When coupled)	IP67
Connector B	Male, M12 × 1, Straight, A-code
Design specification	Acc. to IEC 61076-2-101
Number of contacts	4
Contacts	Brass, CuZn, Gold-plated
Contact carriers	Plastic, Nylon or TPU, Black
Connector body	Plastic, TPU, Black
Coupling nut	Brass, CuZn, Nickel-plated
Tightening torque	0.8 ... 1 Nm

Features



- M12, Female, Straight, 4-pin
- M12, Male, Straight, 4-pin
- Welding Cable
- Yellow Aramid braid over cable jacket
- Black TPE jacket, 4X22 AWG
- Flame Ratings: UL1061, CSA FT1

Cable cross section

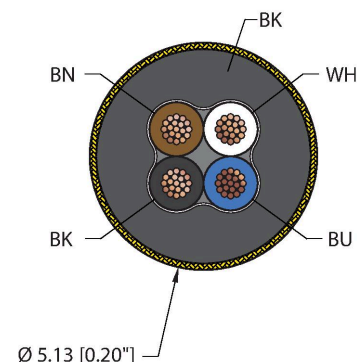

Contact assignment

RK 4.4T-2-RS 4.4T/S3415 | 21-02-2025 22-48 | Technische Änderungen vorbehalten

Technische Daten

	(note max. torque of mating connector!)
Mechanical life	> 100 Mating cycles
Pollution degree	3
Protection class (When coupled)	IP67
Cable data	
Cable ID	RF52454
Total number of conductors	4
Cable diameter	Ø 5.13 mm
Length (L)	2 m
Cable jacket	TPE, Black
Cable jacket covering	Aramid braid, Yellow, 100 % coverage
Conductor diameter	0.048 "
Conductor material	TC (tinned copper)
Conductor insulation material	PVC
Conductor size	4 x 22 AWG [Similar to 0.34 mm ²]
Number of strands x O.D.	19 x 0.0058 "
Conductor colors	BN, WH, BU, BK
Electrical properties at +20 °C	
Rated voltage	250 V
Current	4 A
Mechanical and chemical properties	
Bending radius (static)	≥ 5 x Ø
Bending radius (dynamic)	≥ 10 x Ø
Ambient temperature range (static)	-40...+105 °C
Ambient temperature range (dynamic)	5...+105 °C
Temperature range (installation)	-10...+105 °C
Approval	
Approvals	UL 2238 CE UKCA RoHS
Note	
	- Flex ratings may be reduced if used in extreme temperatures, exposure to certain chemicals, operating above the rated cycle speed, or operating below the rated cable bend radius.
	- We reserve the right to make technical alterations without prior notice.

Connector A

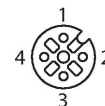

Connector B

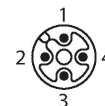

Circuit Diagram



Montagezubehör

TORQUE-WRENCH-SET-M12-LEGACY

A900153

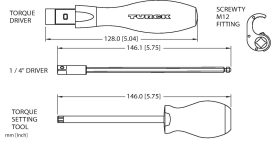

Adjustable torque driver to connect to a Ø15mm knurl. Compatible with the redesigned and legacy M12 cordsets. Includes (1) adjustable torque driver, (1) adjustment tool, (1) 1/4"square to 4mm hex adaptor bit, and (1) Ø15mm spring loaded clamp bit

BS 8141-0

U6550

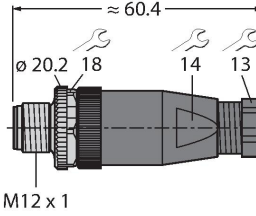

Field-wireable male connector, M12 x 1, straight, 4-pin, screw terminal connection, cable feedthrough 4.0 to 6.0 mm, core cross-section/terminal capacity 0.14 to 0.75 mm², plastic housing, metal retaining screw

B 8141-0

U6545

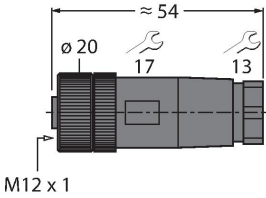

Field-wireable female connector, M12 x 1, straight, 4-pin, screw terminal connection, cable feedthrough 4.0 to 6.0 mm, core cross-section/terminal capacity 0.14 to 0.75 mm², plastic housing, plastic coupling nut

Montagezubehör

M12-CORDSETS-MOUNTING-CLIP-(10/BAG)

100016882

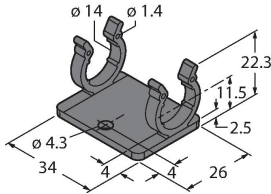

10 Pack of black mounting clips and M4x8mm mounting screws, used to secure cable to cable connection points.