

RK 4.6T-5-RS 4.6T/S90

Actuator and Sensor Cable – Extension Cable

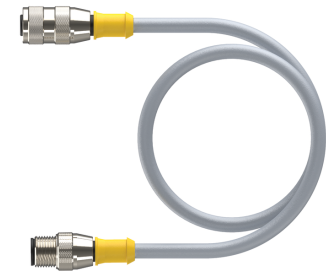
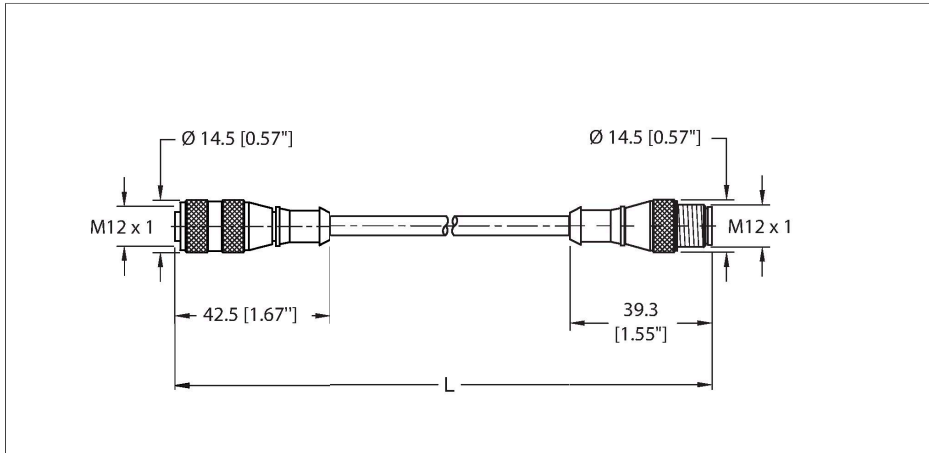

Technische Daten

| | |
|---------------------------------|---|
| Type | RK 4.6T-5-RS 4.6T/S90 |
| ID | UX13584 |
| Connector A | Female, M12 × 1, Straight, A-code |
| Design specification | Acc. to IEC 61076-2-101 |
| Number of contacts | 6 |
| Contacts | Brass, CuZn, Gold-plated |
| Contact carriers | Plastic, Nylon or TPU, Black |
| Connector body | Plastic, TPU, Yellow |
| Coupling nut | Brass, CuZn, Nickel-plated |
| Connector seal | O-ring, Plastic, FKM/FPM |
| Tightening torque (range) | 0.8 ... 1 Nm (note max. torque of mating connector!) |
| Mechanical life | > 100 Mating cycles |
| Pollution degree | 3 |
| Protection class (When coupled) | IP68, IP69K NEMA: 1, 3, 4, 6P |
| Connector B | Male, M12 × 1, Straight, A-code |
| Design specification | Acc. to IEC 61076-2-101 |
| Number of contacts | 6 |
| Contacts | Brass, CuZn, Gold-plated |
| Contact carriers | Plastic, PA, Yellow |
| Connector body | Plastic, TPU, Yellow |
| Coupling nut | Brass, CuZn, Nickel-plated |
| Tightening torque | 0.8 ... 1 Nm (note max. torque of mating connector!) |

Features



- M12, Female, Straight, 6-pin
- M12, Male, Straight, 6-pin
- General Purpose Cable
- TPU jacket, Gray, 6X24 AWG
- -40 Cold Bend Rating
- Flame Ratings: UL1061, CSA FT1
- Flexlife® and C-Track Approved

Cable cross section

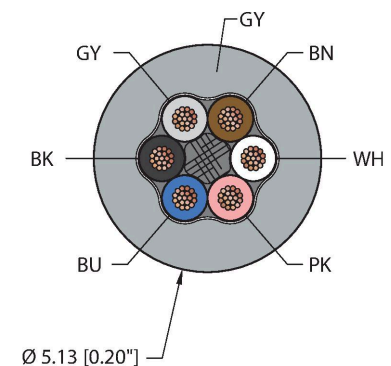

Contact assignment

RK 4.6T-5-RS 4.6T/S90 | 21-02-2025 22-19 | Technische Änderungen vorbehalten

Technische Daten

| | |
|---------------------------------|---------------------|
| Mechanical life | > 100 Mating cycles |
| Pollution degree | 3 |
| Protection class (When coupled) | IP68, IP69K |
| | NEMA: 1, 3, 4, 6P |

| Cable data | |
|-------------------------------|---|
| Cable ID | RF50646 |
| Total number of conductors | 6 |
| Cable diameter | Ø 5.13 mm |
| Length (L) | 5 m, (+50mm or 4% of length/-0.0, Whichever is greater) |
| Cable jacket | TPU, Gray |
| Conductor diameter | 0.044 " |
| Conductor material | TC (tinned copper) |
| Conductor insulation material | PVC |
| Conductor size | 6 x 24 AWG [Similar to 0.25 mm ²] |
| Number of strands x O.D. | 19 x 36 AWG |
| Conductor colors | BN, WH, PK, BU, BK, GY |

| Electrical properties at +20 °C | |
|---------------------------------|------|
| Rated voltage | 75 V |
| Current | 4 A |

| Mechanical and chemical properties | |
|------------------------------------|-------------------|
| Bending radius (static) | ≥ 5 x Ø |
| Bending radius (dynamic) | ≥ 10 x Ø |
| UL cold bend rating | -40 °C |
| Flex rating 20 x Ø | 10 million cycles |

| | |
|-------------------------------------|--|
| | *When properly installed @ 20°C, 50%RH, and a cycle speed of ≤0.5 cycles per second. |
| C-Track | Yes |
| Ambient temperature range (static) | -40...+90 °C |
| Ambient temperature range (dynamic) | 5...+90 °C |
| Temperature range (installation) | -10...+90 °C |

| Approval | |
|-----------|------|
| Approvals | RoHS |

| Note | |
|------|--|
| | - Flex ratings may be reduced if used in extreme temperatures, exposure to certain chemicals, operating above the rated cycle speed, or operating below the rated cable bend radius. |

Connector A

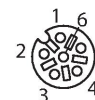

Connector B

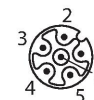

Circuit Diagram

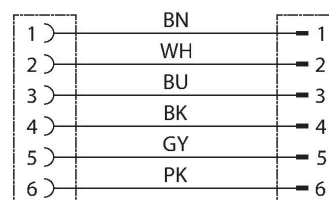

Technische Daten

- We reserve the right to make technical alterations without prior notice.

Montagezubehör

TORQUE-WRENCH-SET-M12-LEGACY A900153

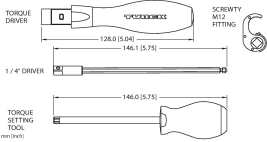

Adjustable torque driver to connect to a Ø15mm knurl. Compatible with the redesigned and legacy M12 cordsets. Includes (1) adjustable torque driver, (1) adjustment tool, (1) 1/4"square to 4mm hex adaptor bit, and (1) Ø15mm spring loaded clamp bit

Montagezubehör

M12-CORDSETS-MOUNTING-CLIP-(10/BAG) 100016882

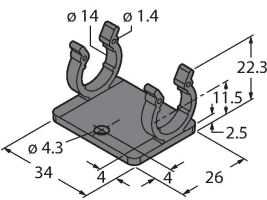

10 Pack of black mounting clips and M4x8mm mounting screws, used to secure cable to cable connection points.